

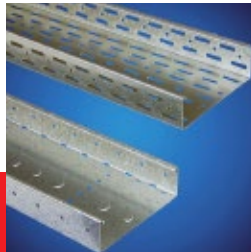

# Liste des prix systèmes de support de câbles

Janvier 2018



# A propos de nous

Depuis 1977, Stagobel Electro est l'importateur exclusif pour le marché belge des matériaux d'installation électriques de fabricants renommés, belges et internationaux. Nous fournissons des produits et services, qui permettent à nos clients de consolider la sécurité, la fiabilité, la flexibilité, la durabilité et le confort des installations électriques dans l'industrie, les bureaux et les habitations.

Notre portfolio de produits se concentre sur cinq domaines: les systèmes de support de câbles pour l'industrie et les bureaux, le matériel de contact industriel CEE, la gestion des bâtiments, la protection contre la foudre et les surtensions et les stations de recharge pour l'e-mobility.

## QUALITÉ

Nos partenaires-fabricants prônent des valeurs telles que l'innovation, la qualité, le design et la sécurité. Ils méritent toute votre confiance. Leurs produits, soigneusement conçus, répondent aux exigences du client. Nos fabricants innovent et investissent dans l'avenir afin de vous offrir le meilleur appui possible.

## SUPPORT MATTERS!

Au fil des ans, la connaissance spécialisée de nos produits a été soigneusement édifée au sein de notre équipe de spécialistes bien formés et expérimentés. Nous aimons réfléchir avec vous. Vous pouvez compter sur notre support pour tout conseil durant la phase de conception, d'exécution ou de mise en service de votre projet. Rapide et professionnel. En ce qui concerne notre département de gestion des bâtiments, vous pouvez en outre compter sur un service professionnel après-vente.

## COMPÉTENCE

Nous aimons partager notre connaissance et expérience. Suivez nos workshops, formations, séminaires, tous fréquemment organisés et bien fréquentés, et restez ainsi au courant de tous les nouveaux développements et tendances. Ainsi, vous pouvez conseiller vos clients en toute connaissance de cause.

## PARTENARIAT

En tant que PME familiale, nous sommes persuadés que nos clients forment la base de notre entreprise. Un partenariat solide avec nos clients et nos fabricants constitue le fondement de notre organisation pour l'avenir. Que ce soit pour une question technique simple, une offre, une livraison ou la réception de travaux ... l'on peut toujours compter sur Stagobel Electro. Grâce à une étroite collaboration avec le réseau des électro-grossistes professionnels, nos produits sont aisément et rapidement disponibles dans toute la Belgique. Nous promettons uniquement ce que nous pouvons réaliser et nous considérons nos accords comme impératifs et contraignants.



Stock étendu, délai de livraison court.



Notre showroom.



Notre équipe technique pour un soutien rapide et professionnel.





Notre connaissance reste à jour, grâce à nos formations.





# Contenu

	page
Echelles à câbles WIBE	3
Gaines à câbles et chemins de câbles STAGO	29
Chemins de câbles et gaines à câbles PEMSA	47
Systèmes de support de câbles en matière composite MITA	73
Treillis à câbles PEMSA	75
Système de suspension avec câble SPIDERBAND 	101
Profilés STAGOBEL et accessoires 	105
Systèmes de support de câbles avec maintien de fonction	113
Systèmes de gaines de sol PUK	125
Gaines murales en aluminium et en matière synthétique DUCTEL	161
Canalisations à câbles en matière synthétique KOPOS	177
Colonnes de distribution et de bureau en aluminium IDT	205
Connexions bureautiques IBCONNECT	211
Index	227
Conditions de vente générales	240

# Légende

Général		Caractéristiques	
	Tous les prix bruts sont en euro, hors TVA. Les prix des articles vendus par longueurs s'entendent au mètre. Les prix des accessoires s'entendent par pièce, par set ou par boîte.		Info supplémentaire
	Nouveau dans l'assortiment.		Largeur (mm)
	Cet article est uniquement livré en emballage standard.		Hauteur (mm)
	Cette longueur est uniquement livrée en longueur standard.	L mm	Longueur (mm)
	Pour faciliter le transport, il est recommandé de commander cet article dans la quantité indiquée.		Charge légère
			Charge moyenne
			Charge élevée
			Maintien de fonction E60/E90

Applications	
	Industrie
	Tertiaire
	Tunnels
	Centres de données
	Installations PV
	Industrie alimentaire
	Pétrochimie

Traitement de surface		
Traitement de surface		Recommandé dans les environnements corrosifs mentionnés ci-après selon NBN- EN ISO 12944-2
E.Z.	Zingage électrolytique NBN EN ISO 2081	C1 (très faible)
G.S.	Galvanisation Sendzimir NBN EN 10346	C2 (faible)
Z.B.	Zingage électrolytique, bichromaté NBN EN ISO 2081	C2 (faible)
H.D.	Galvanisation à chaud NBN EN ISO 1461	C3/C4 (moyen/haut)
INOX 304	Acier inoxydable AISI 304	C5-I (très élevé – industrie)
C8	Black C8, Protection Haute Résistance, Class 8 IEC 61537	C5-I (très élevé – industrie)
Zinkpox blanc	Galvanisation à chaud + epoxy coating	C5-I (très élevé – industrie)
INOX 316L	Acier inoxydable AISI 316	C5-M (très élevé – maritime)

## Les environnements corrosifs selon NBN EN ISO 12944-2

	C1	Bâtiments chauffés à faible exposition à la corrosion, comme p. ex. les hôtels et les bureaux.
	C2	Bâtiments non chauffés dans des atmosphères à faible taux de pollution (généralement dans des zones rurales), comme p.ex. les entrepôts et les parkings souterrains.
	C3	Villes et environnements de l'industrie légère à corrosion environnementale moyenne, comme p.ex. les blanchisseries, les brasseries et l'industrie alimentaire.
	C4	Environnements industriels et zones côtières à taux de salinité moyen et présentant un taux élevé de corrosion environnementale, d'humidité de l'air et de pollution de l'air, comme p.ex. les entreprises chimiques, les zones portuaires et les piscines.
	C5-I	Environnements présentant un taux élevé d'humidité de l'air et de pollution de l'air presque constant, comme p.ex. les industries chimiques et lourdes, les tunnels et les zones portuaires.
	C5-M	Environnements présentant un taux élevé d'humidité de l'air, de pollution de l'air et de salinité presque constant, comme p.ex. les zones côtières et offshore.







# Échelles à câbles









**La colonne vertébrale d'une structure exceptionnelle**

Les systèmes de support de câbles sont essentiels à l'infrastructure d'un bâtiment, de la même manière que l'est la colonne vertébrale pour notre corps. Les échelles à câbles WIBE sont solides et fonctionnelles et peuvent être montées à l'horizontale ou à la verticale. Fort d'une vaste gamme d'accessoires et d'une grande variété de traitements de surface, le système d'échelles à câbles WIBE constitue une gamme sûre, flexible et facile d'entretien, pouvant être montée dans toutes les directions et dans tous les angles.











# Aperçu

<b>KHZSP KHZSPZ</b>	<b>KHZPS KHZP</b>	<b>KHZ</b>	<b>KHZPV</b>	<b>KHZV</b>
Profilé ouvert échelon perforé	Profilé fermé échelon perforé	Profilé fermé échelon rond	Profilé fermé renforcé échelon perforé	Profilé fermé renforcé échelon rond
				

## Caractéristiques

<b>G.S.</b>	✓	✓			
<b>H.D.</b>	✓	✓	✓	✓	✓
<b>ZINKPOX blanc</b>		✓	✓	✓	✓
<b>INOX 316L</b>		✓	✓	✓	
 mm	200-600	150-1000	150-600	200-1000	200-600
 mm	55	55	55	150	150
<b>L mm</b>	3000-4000-6000	6000	6000	6000	6000
 N/m					
		E60			

## Applications

 Industrie		✓	✓	✓	✓
 Tertiaire	✓				
 Tunnels	✓	✓	✓	✓	✓
 Centres de données	✓	✓	✓		
 Installations PV	✓	✓	✓		
 Industrie alimentaire			✓		✓
 Pétrochimie/pharma		✓	✓	✓	✓
 <b>G.S.</b>	page 5	page 5	-	-	-
 <b>H.D.</b>	page 5	page 5	page 6	page 6	page 6
 <b>ZINKPOX BLANC</b>	-	sur demande	sur demande	sur demande	sur demande
 <b>INOX 316L</b>	-	page 5	page 6	page 6	-

**G.S.**

Galvanisé Sendzimir NBN EN10346 – recommandé dans les environnements corrosifs C2 (faible)

**H.D.**

Galvanisé à chaud NBN EN ISO 1461 – recommandé dans les environnements corrosifs C3/C4 (moyen/haut)

**Zinkpox blanc**

Galvanisé à chaud + epoxy coating – recommandé dans les environnements corrosifs C5-I (très élevé/industrie)

**INOX 316L**

Acier inoxydable AISI 316 – recommandé dans les environnements corrosifs C5-M (très élevé/maritime)

 voir page 2



# Echelles à câbles



## Echelle à câbles KHZSP

type	référence	page catal.	groupe d'articles	prix en €	
Acier galvanisé Sendzimir	200	783155	21	1303	19,60/m
	300	783156	21	1303	24,15/m
	400	783157	21	1303	27,47/m
	500	783158	21	1303	31,97/m
	600	783159	21	1303	35,24/m

3 m

## Echelle à câbles KHZSP

type	référence	page catal.	groupe d'articles	prix en €	
Acier galvanisé Sendzimir	200	718572	21	1303	19,60/m
	300	718573	21	1303	24,15/m
	400	718574	21	1303	27,47/m
	500	718575	21	1303	31,97/m
	600	718576	21	1303	35,24/m

4 m

## Echelle à câbles KHZSP

type	référence	page catal.	groupe d'articles	prix en €	
Acier galvanisé Sendzimir	200	734488	21	1303	19,60/m
	300	734489	21	1303	24,15/m
	400	734490	21	1303	27,47/m
	500	734491	21	1303	31,97/m
	600	734492	21	1303	35,24/m

6 m

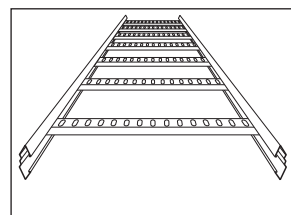

## Echelle à câbles KHZSPZ

type	référence	page catal.	groupe d'articles	prix en €	
Acier galvanisé à chaud	200	734494	22	1301	36,52/m
	300	734495	22	1301	38,15/m
	400	734496	22	1301	40,84/m
	500	734497	22	1301	44,33/m
	600	734498	22	1301	46,79/m

6 m

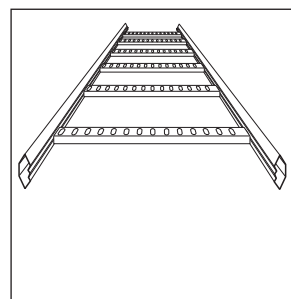

## Echelle à câbles KHZPS

type	référence	page catal.	groupe d'articles	prix en €	
Acier galvanisé Sendzimir	150	725350	23	1308	38,22/m
	200	725351	23	1308	38,22/m
	300	725352	23	1308	39,53/m
	400	725353	23	1308	41,18/m
	500	725354	23	1308	43,34/m
	600	725355	23	1308	45,62/m
	800	781099	23	1308	69,67/m
	1000	725356	23	1308	107,31/m

6 m

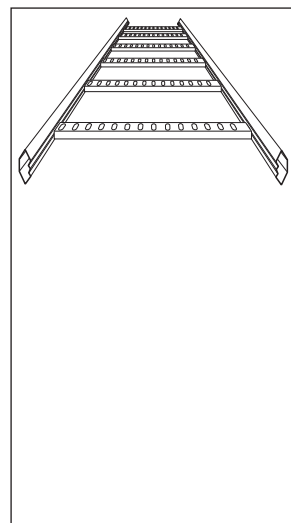

## Echelle à câbles KHZP

type	référence	page catal.	groupe d'articles	prix en €	
Acier galvanisé à chaud	150	718562	25	1312	44,20/m
	200	718563	25	1312	44,20/m
	300	718564	25	1312	46,07/m
	400	718565	25	1312	48,10/m
	500	718566	25	1312	51,65/m
	600	718567	25	1312	53,78/m
	800	721960	25	1312	98,12/m
	1000	718568	25	1312	164,30/m

6 m

## Echelle à câbles KHZP

type	référence	page catal.	groupe d'articles	prix en €	
Acier inoxydable AISI 316L	150	727382	25	1305	sur demande
	200	727383	25	1305	sur demande
	300	727384	25	1305	sur demande
	400	727385	25	1305	sur demande
	500	727386	25	1305	sur demande
	600	727387	25	1305	sur demande

6 m

# Echelles à câbles

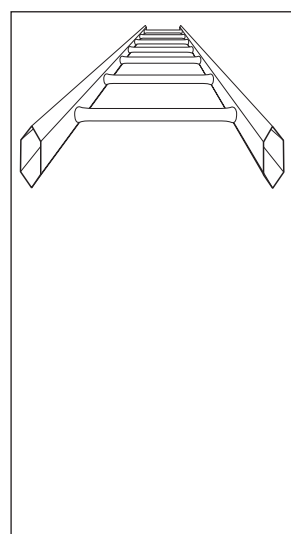

## Echelle à câbles KHZ

	type	référence	page catal.	groupe d'articles	prix en €	
	Acier galvanisé à chaud	150	768001	24	1301	54,78/m
		200	768002	24	1301	54,78/m
		300	768004	24	1301	56,88/m
		400	768005	24	1301	59,51/m
		500	768006	24	1301	63,87/m
		600	768007	24	1301	66,64/m

## Echelle à câbles KHZ

	type	référence	page catal.	groupe d'articles	prix en €	
	Acier inoxydable AISI 316L	150	727376	24	1305	sur demande
		200	727377	24	1305	sur demande
		300	727378	24	1305	sur demande
		400	727379	24	1305	sur demande
		500	727380	24	1305	sur demande
		600	727381	24	1305	sur demande

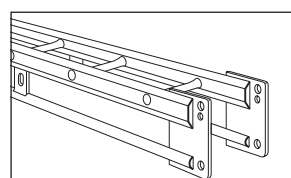

## Echelle à câbles KHZV

	type	référence	page catal.	groupe d'articles	prix en €	
	Acier galvanisé à chaud	200	712015	26	1301	109,24/m
		300	712017	26	1301	112,11/m
		400	712019	26	1301	114,55/m
		500	712018	26	1301	118,77/m
		600	712020	26	1301	120,13/m

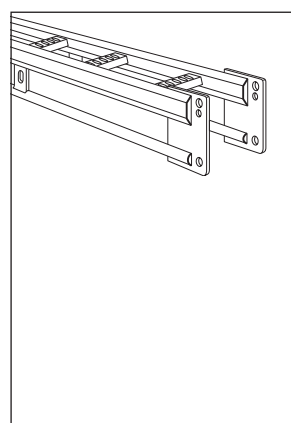

## Echelle à câbles KHZPV

	type	référence	page catal.	groupe d'articles	prix en €	
	Acier galvanisé à chaud	200	717982	27	1301	109,24/m
		300	717983	27	1301	112,11/m
		400	717984	27	1301	114,55/m
		500	717985	27	1301	118,77/m
		600	717986	27	1301	120,13/m
		1000	716400	27	1301	282,12/m

## Echelle à câbles KHZPV

	type	référence	page catal.	groupe d'articles	prix en €	
	Acier inoxydable AISI 316L	200	784066	27	1305	sur demande
		300	784067	27	1305	sur demande
		400	784068	27	1305	sur demande
		500	784069	27	1305	sur demande
		600	784070	27	1305	sur demande

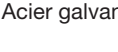

## Console 50i

	type	référence	page catal.	groupe d'articles	prix en €	
	Acier galvanisé Sendzimir	50i/ 100	791412	30	1304	4,17/pc.
		50i/ 200	791413	30	1304	5,80/pc.
		50i/ 300	791414	30	1304	7,05/pc.
		50i/ 400	791415	30	1304	11,40/pc.
		50i/ 500	795322		1304	17,73/pc.
		50i/ 600	795323		1304	20,14/pc.

## Console 50i

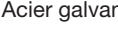
	type	référence	page catal.	groupe d'articles	prix en €	
	Acier galvanisé à chaud	50i/ 100	795316		1304	7,56/pc.
		50i/ 200	795317		1304	8,54/pc.
		50i/ 300	795318		1304	12,51/pc.
		50i/ 400	795319		1304	14,20/pc.
		50i/ 500	795320		1304	19,34/pc.
		50i/ 600	795321		1304	21,83/pc.

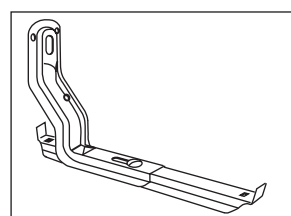

## Console 30

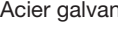
	type	référence	page catal.	groupe d'articles	prix en €	
	Acier galvanisé Sendzimir	30/ 200	727777	31	1313	36,99/pc.
		30/ 300	727778	31	1313	40,39/pc.
	Seulement pour échelles à câbles KHZSP.	30/ 400	727779	31	1313	45,04/pc.
		30/ 500	727780	31	1313	50,00/pc.
		30/ 600	727781	31	1313	51,41/pc.



# Echelles à câbles



## Console 50

	type	référence	page catal.	groupe d'articles	prix en €
Acier galvanisé à chaud	50/ 100	723432	32	1304	13,33/pc.
	50/ 150	723433	32	1304	13,48/pc.
	50/ 200	723434	32	1304	13,83/pc.
	50/ 250	723435	32	1304	15,63/pc.
	50/ 300	723436	32	1304	15,92/pc.
	50/ 400	723437	32	1304	25,16/pc.
	50/ 500	723438	32	1304	33,27/pc.
	50/ 600	723439	32	1304	34,94/pc.
	50/ 700	727125	32	1304	68,19/pc.
	50/ 800	727126	32	1304	71,85/pc.
	50/ 900	727127	32	1304	79,18/pc.
50/ 1000	727128	32	1304	84,91/pc.	

## Console 50

	type	référence	page catal.	groupe d'articles	prix en €
Acier inoxydable AISI 316L	50/ 100	725618	32	1305	sur demande
	50/ 150	725619	32	1305	sur demande
	50/ 200	725620	32	1305	sur demande
	50/ 250	725621	32	1305	sur demande
	50/ 300	725622	32	1305	sur demande
	50/ 400	725623	32	1305	sur demande
	50/ 500	725624	32	1305	sur demande
	50/ 600	725625	32	1305	sur demande

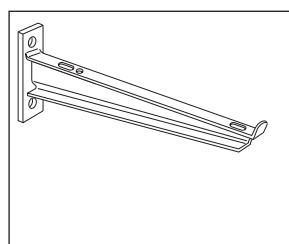

## Console 50F

	type	référence	page catal.	groupe d'articles	prix en €
Acier galvanisé à chaud	50F/ 200	718624	32	1313	48,35/pc.
	50F/ 300	718625	32	1313	52,35/pc.
	50F/ 400	718626	32	1313	60,15/pc.
	50F/ 500	718627	32	1313	68,12/pc.
	50F/ 600	718628	32	1313	76,02/pc.
	50F/ 1000	712465	32	1313	197,36/pc.

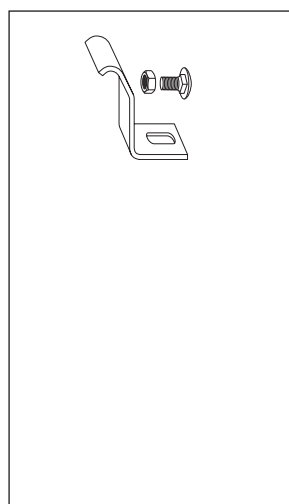

## Etrier 42

	type	référence	page catal.	groupe d'articles	prix en €
Acier galvanisé Sendzimir	42	795240		1313	3,80/pc.



## Etrier 42

	type	référence	page catal.	groupe d'articles	prix en €
Zinc+	42	795241		1313	5,28/pc.
Acier galvanisé à chaud	42	795242		1313	6,02/pc.







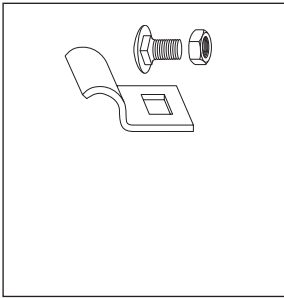
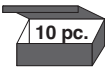
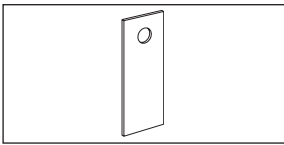

## Etrier 42

	type	référence	page catal.	groupe d'articles	prix en €
Acier inoxydable AISI 316L	42	725763	34	1305	sur demande

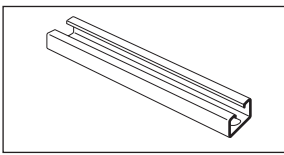
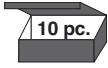
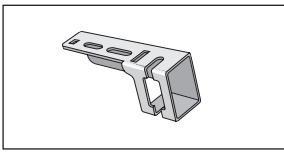
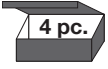
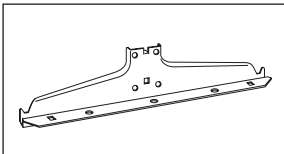
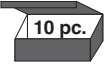

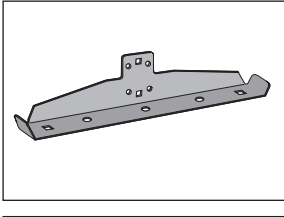
# Echelles à câbles

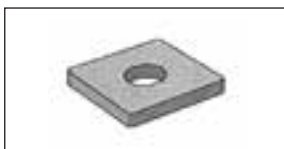
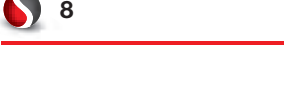
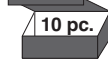



	type	référence	page catal.	groupe d'articles	prix en €	
	<b>Etrier 43</b>					
	Acier galvanisé à chaud	43	707511	34	1313	9,23/pc.
						
	<b>Etrier 43</b>					
	Acier inoxydable AISI 316L	43	792893	34	1305	sur demande
						
	<b>Plaque de fond 40</b>					
	Acier galvanisé à chaud	40	768738	35	1313	17,84/pc.
						
	<b>Profilé de suspension 40</b>					
	Acier galvanisé à chaud L = 270 mm	40	717001	35	1313	23,43/pc.
						
	<b>Fixation tige/ console 82</b>					
	Acier galvanisé à chaud	82	786768	36	1313	63,65/pc.
						
	<b>Support console 3</b>					
	Acier galvanisé Sendzimir	3/ 200	721869	38	1313	12,41/pc.
		3/ 300	721870	38	1313	16,92/pc.
		3/ 400	721871	38	1313	18,13/pc.
		3/ 500	721872	38	1313	24,03/pc.
		3/ 600	721873	38	1313	26,30/pc.
	<b>Support console 3</b>					
	Acier galvanisé à chaud	3/ 150	720761	38	1313	16,63/pc.
		3/ 200	720762	38	1313	17,36/pc.
		3/ 300	720763	38	1313	19,00/pc.
		3/ 400	720764	38	1313	21,96/pc.
		3/ 500	720765	38	1313	29,30/pc.
	<b>Support console 3</b>					
	Acier inoxydable AISI 316L	3/ 150	726433	38	1305	sur demande
		3/ 200	726434	38	1305	sur demande
		3/ 300	726435	38	1305	sur demande
		3/ 400	726436	38	1305	sur demande
		3/ 500	726437	38	1305	sur demande
	<b>Support console HSO</b>					
	Acier galvanisé à chaud	150/M10	791063	40	1313	19,22/pc.
		200/M10	791064	40	1313	19,64/pc.
		300/M10	791065	40	1313	20,07/pc.
		400/M16	791066	40	1313	20,72/pc.
		500/M16	791067	40	1313	21,51/pc.
	<b>Plaque de fond HSO M16</b>					
	Acier galvanisé à chaud	M16	791092	40	1313	3,79/pc.
						

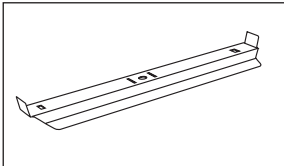
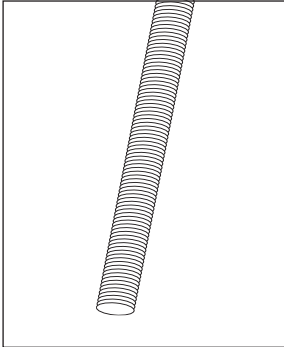
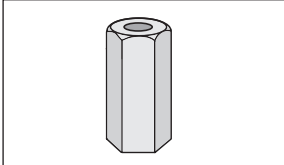
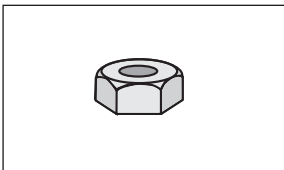
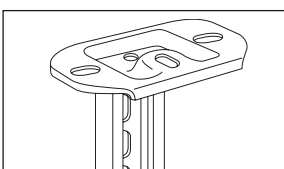
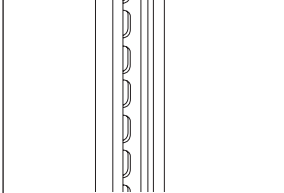
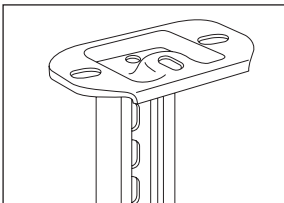
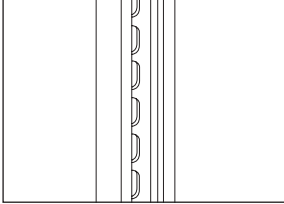



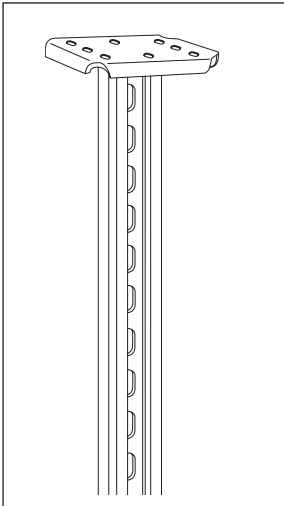
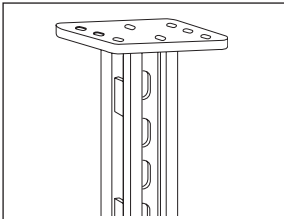
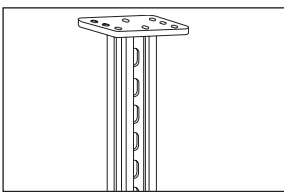
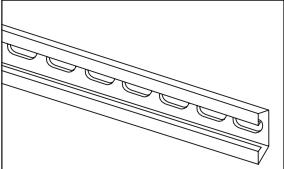
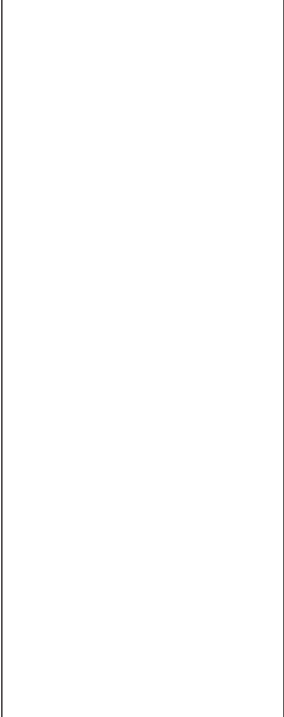

# Echelles à câbles

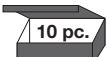
	type	référence	page catal.	groupe d'articles	prix en €	
	<b>Support console 6</b>					
	Acier galvanisé Sendzimir	6/ 200	727582	41	1313	13,64/pc.
		6/ 300	727583	41	1313	15,81/pc.
		6/ 400	727584	41	1313	18,69/pc.
	Seulement pour échelles à câbles KHZSP.	6/ 500	727585	41	1313	23,37/pc.
		6/ 600	727586	41	1313	26,32/pc.
	<b>Tige filetée M10</b>					
	Acier à zingage électrolytique	2000	716792	42	1313	4,57/m
		3000	716793	42	1313	4,57/m
	<b>Tige filetée M10</b>					
	Acier inoxydable AISI 316	2000	723925	42	1305	sur demande
		3000	723926	42	1305	sur demande
	<b>Ecrou de rallonge hexagonal</b>					
	Acier à zingage électrolytique	M10	724806	42	1313	4,74/pc.
	Acier inoxydable AISI 316	M10	724807	42	1305	sur demande
	<b>Ecrou hexagonal</b>					
	Acier galvanisé à chaud	M10	723938	42	1313	0,59/pc.
	Acier inoxydable AISI 316	M10	723939	42	1305	sur demande
	<b>Pendard simple 2</b>					
	Acier galvanisé à chaud	2/ 300	717191	44	1313	15,16/pc.
		2/ 400	717192	44	1313	16,97/pc.
		2/ 500	717193	44	1313	17,83/pc.
		2/ 700	717194	44	1313	24,91/pc.
		2/ 1000	717195	44	1313	29,30/pc.
	<b>Pendard simple 2</b>					
	Acier inoxydable AISI 316L	2/ 300	725557	44	1305	sur demande
		2/ 400	725558	44	1305	sur demande
		2/ 500	725559	44	1305	sur demande
		2/ 700	725560	44	1305	sur demande
		2/ 1000	725561	44	1305	sur demande
	<b>Pendard simple 2F</b>					
	Acier galvanisé à chaud	2F/ 280	717196	46	1313	21,09/pc.
		2F/ 370	717197	46	1313	24,10/pc.
		2F/ 505	717198	46	1313	27,36/pc.
		2F/ 730	717199	46	1313	31,40/pc.
		2F/ 1000	717200	46	1313	36,07/pc.
		2F/ 1500	787276	46	1313	104,74/pc.
	<b>Pendard simple 2F</b>					
	Acier inoxydable AISI 316L	2F/ 280	725562	46	1305	sur demande
		2F/ 370	725563	46	1305	sur demande
		2F/ 505	725564	46	1305	sur demande
		2F/ 730	725565	46	1305	sur demande
		2F/ 1000	725566	46	1305	sur demande
		2F/ 1500	787278	46	1305	sur demande



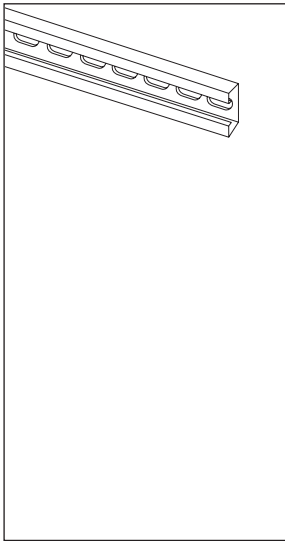
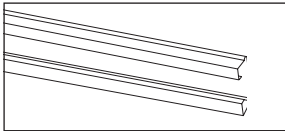
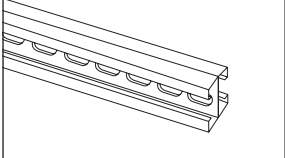
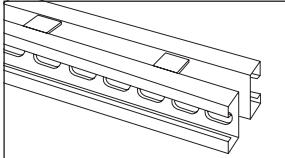
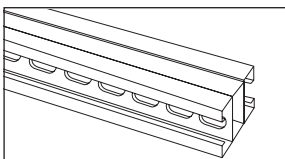
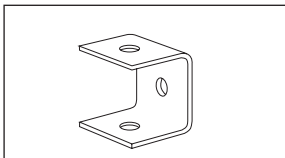
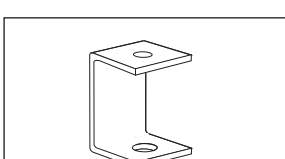

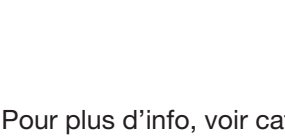

# Echelles à câbles

	type	référence	page catal.	groupe d'articles	prix en €	
	<b>Pendard double 20</b>					
	Acier galvanisé à chaud	20/ 505	715723	48	1313	65,51/pc.
		20/ 730	715724	48	1313	79,68/pc.
		20/ 1000	715725	48	1313	100,92/pc.
		20/ 1500	715726	48	1313	131,73/pc.
		20/ 2000	715727	48	1313	165,51/pc.
	20/ 3000	715728	48	1313	274,06/pc.	
	<b>Pendard double 20</b>					
	Acier inoxydable AISI 316L	20/ 505	725567	48	1305	sur demande
		20/ 730	725568	48	1305	sur demande
		20/ 1000	725569	48	1305	sur demande
		20/ 1500	725570	48	1305	sur demande
		20/ 2000	725571	48	1305	sur demande
	20/ 3000	725572	48	1305	sur demande	
	<b>Pendard double 20F</b>					
	Acier galvanisé à chaud	20F/ 1000	718249	50	1313	127,09/pc.
		20F/ 1500	718250	50	1313	171,89/pc.
		20F/ 2000	718251	50	1313	212,92/pc.
	20F/ 3000	709799	50	1313	286,68/pc.	
	<b>Pendard double 20FS</b>					
	Acier galvanisé à chaud	20FS/ 1500	718718	52	1313	326,59/pc.
		20FS/ 2000	718719	52	1313	390,47/pc.
		20FS/ 2500	718720	52	1313	515,72/pc.
	20FS/ 3000	718721	52	1313	576,16/pc.	
	<b>Profilé de suspension 24/34</b>					
	Acier galvanisé Sendzimir	3000	721102	54	1313	11,14/m
						
	<b>Profilé de suspension 24/34</b>					
	Acier galvanisé Sendzimir	300	725357	54	1313	6,64/pc.
		400	725358	54	1313	7,51/pc.
		500	725359	54	1313	8,87/pc.
		700	725360	54	1313	11,53/pc.
		1000	725361	54	1313	15,05/pc.
						
<b>Profilé de suspension 24/34</b>						
Acier galvanisé à chaud	3000	715879	54	1313	19,13/m	
						
<b>Profilé de suspension 24/34</b>						
Acier inoxydable AISI 316L	3000	725579	54	1305	sur demande	
						
<b>Profilé de suspension 24/34</b>						
Acier inoxydable AISI 316L	300	725574	54	1305	sur demande	
	400	725575	54	1305	sur demande	
	500	725576	54	1305	sur demande	
	700	725577	54	1305	sur demande	
	1000	725578	54	1305	sur demande	
						

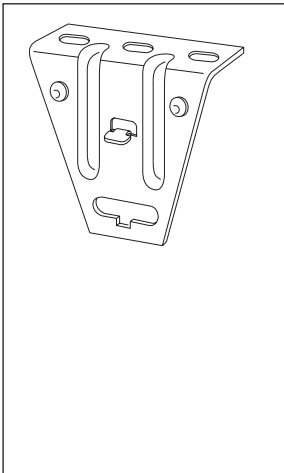
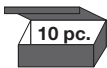
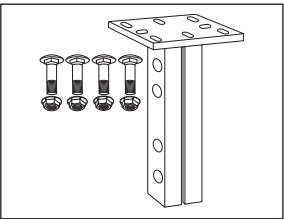
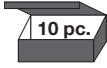
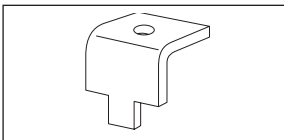
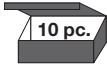
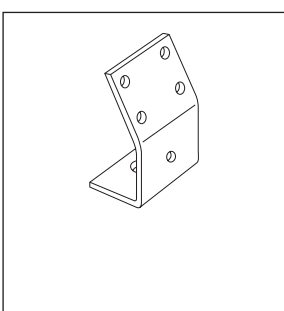
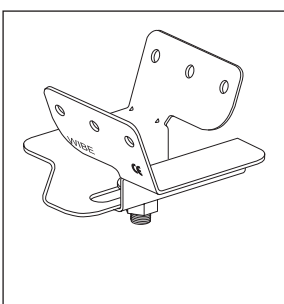



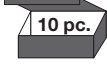
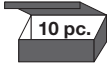

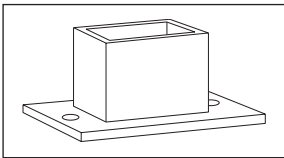
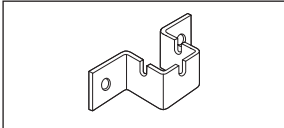
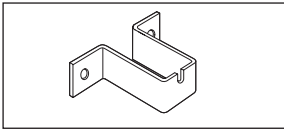
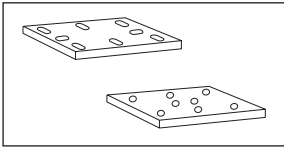
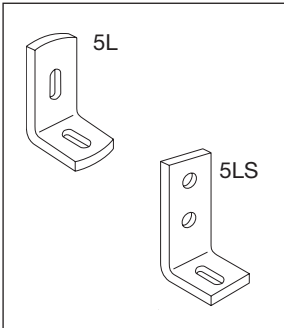

# Echelles à câbles

	type	référence	page catal.	groupe d'articles	prix en €	
	<b>Profilé de suspension 24/48</b>					
	Acier galvanisé Sendzimir	3000 6000	731717 731721	55 55	1313 1313	24,80/m 24,80/m
	<div style="display: flex; justify-content: space-around;"> <span>← 3 m →</span> <span>← 6 m →</span> </div>					
	<b>Profilé de suspension 24/48</b>					
	Acier galvanisé à chaud	3000 6000	705093 731719	55 55	1313 1313	29,20/m 29,20/m
	<div style="display: flex; justify-content: space-around;"> <span>← 3 m →</span> <span>← 6 m →</span> </div>					
	<b>Profilé de suspension 24/48</b>					
	Acier inoxydable AISI 316L	3000 6000	728595 731727	55 55	1305 1305	sur demande sur demande
	<div style="display: flex; justify-content: space-around;"> <span>← 3 m →</span> <span>← 6 m →</span> </div>					
	<b>Rail à encastrer 24/26 x 53</b>					
	Acier galvanisé à chaud	4000	768063	56	1313	40,21/m
	<b>Profilé de suspension 24/20</b>					
	Acier galvanisé à chaud	3000	709795	57	1313	85,55/m
	<b>Profilé de suspension 24/20F</b>					
	Acier galvanisé à chaud	3000 6000	709798 718808	58 58	1313 1313	113,73/m 113,73/m
	<div style="display: flex; justify-content: space-around;"> <span>← 3 m →</span> <span>← 6 m →</span> </div>					
	<b>Profilé de suspension 24/20FS</b>					
	Acier galvanisé à chaud	6000	709031	59	1313	160,30/m
	<b>Etrier de plafond TF-10</b>					
	Acier galvanisé à chaud	TF10	788164	60	1313	19,36/pc.
<div style="display: flex; align-items: center;">  <span>10 pc.</span> </div>						
Ecrou M10 inclus.						
	<b>Etrier de plafond TF-16</b>					
	Acier galvanisé à chaud	TF16	788165	60	1313	27,78/pc.
<div style="display: flex; align-items: center;">  <span>10 pc.</span> </div>						
Ecrou M16 inclus.						

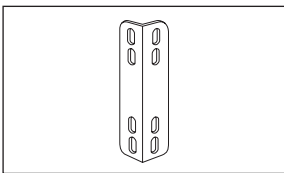
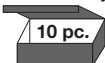
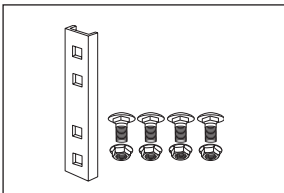
# Echelles à câbles

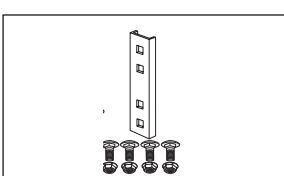







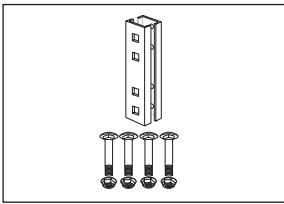
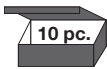

	type	référence	page catal.	groupe d'articles	prix en €	
	<b>Etrier de plafond 5</b>					
	Acier galvanisé Sendzimir	5	721101	61	1313	9,87/pc.
						
	<b>Etrier de plafond 5</b>					
	Acier galvanisé à chaud	5	718640	61	1313	14,29/pc.
						
	<b>Etrier de plafond 5</b>					
	Acier inoxydable AISI 316L	5	725573	61	1305	sur demande
						
	<b>Base pour pendeur 520</b>					
	Acier galvanisé à chaud	520	718253	62	1313	181,56/pc.
	<b>Etrier pour poutre en I 5BK</b>					
	Acier galvanisé à chaud	5BK-10	715675	63	1313	14,70/pc.
		5BK-30	718243	63	1313	15,69/pc.
	<b>Etrier de plafond 5TP</b>					
	Acier galvanisé Sendzimir	5TP	725362	64	1313	10,32/pc.
						
	<b>Etrier de plafond 5TP</b>					
	Acier galvanisé à chaud	5TP	713153	64	1313	11,30/pc.
						
	<b>Etrier de plafond 5TPA</b>					
	Acier galvanisé Sendzimir	5TPA	732177	65	1313	9,42/pc.
						
	<b>Etrier de plafond 5TPA</b>					
	Acier galvanisé à chaud	5TPA	733487	65	1313	11,01/pc.
						

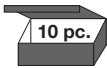
# Echelles à câbles

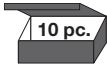
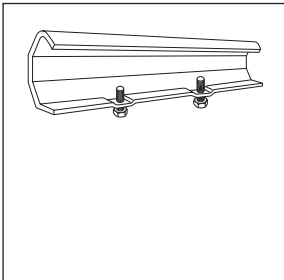
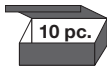
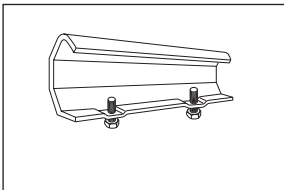

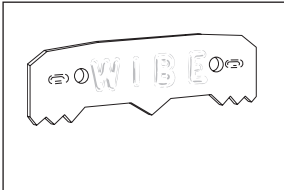
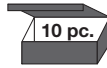

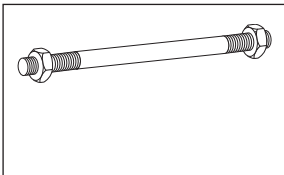

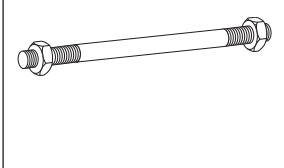
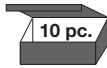
	type	référence	page catal.	groupe d'articles	prix en €	
	<b>Support pour profilé 24/20F ou 24/20FS</b>					
	Acier galvanisé à chaud	24/20F	718850	69	1313	137,34/pc.
		24/20FS	718851	69	1313	151,91/pc.
	<b>Etrier mural 20</b>					
	Acier galvanisé à chaud	20	723450	70	1313	55,29/pc.
	<b>Etrier mural 20F</b>					
	Acier galvanisé à chaud	20F	723451	70	1313	55,88/pc.
	<b>Etrier de plafond 20F ou 20FS</b>					
	Acier galvanisé à chaud	20F	718849	71	1313	33,99/pc.
		20FS	720536	71	1313	131,54/pc.
	<b>Equerre 5L</b>					
	Acier galvanisé à chaud	5L	731791	72	1313	16,18/pc.
	Acier inoxydable AISI 316L	5L	731793	72	1305	sur demande
						
	<b>Equerre 5LS</b>					
	Acier galvanisé à chaud	5LS	709801	72	1313	18,65/pc.
	Acier inoxydable AISI 316L	5LS	725636	72	1305	sur demande
						
	<b>Equerre HT-11</b>					
	Acier galvanisé à chaud	HT-11	717618	73	1313	20,07/pc.
						
	<b>Accouplement d'assemblage 2J</b>					
	Acier galvanisé Sendzimir	2J	721119	74	1313	12,04/pc.
	Acier galvanisé à chaud	2J	713177	74	1313	17,84/pc.
	Acier inoxydable 316L	2J	726484	74	1305	sur demande
						
	<b>Accouplement d'assemblage 2FJ</b>					
	Acier galvanisé à chaud	2FJ	713178	74	1313	18,83/pc.
	Acier inoxydable 316L	2FJ	726485	74	1305	sur demande
						



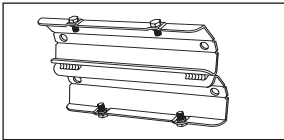
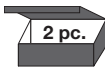
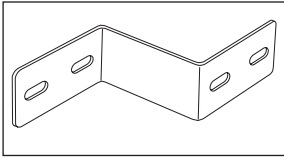
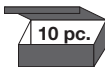
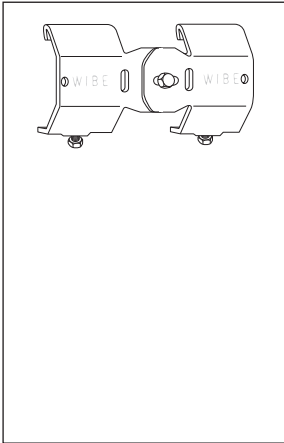
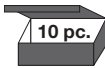
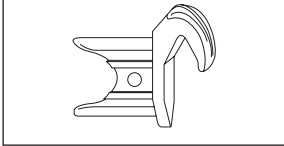
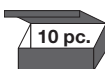
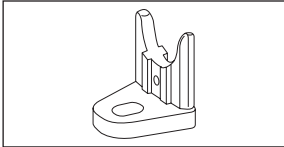

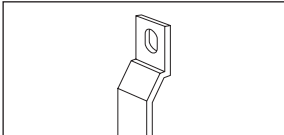
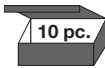
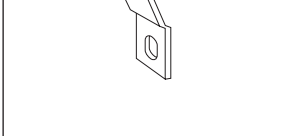
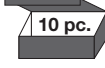

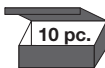

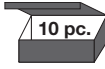

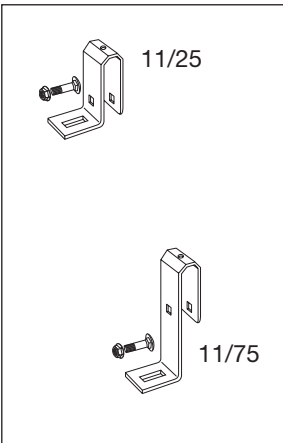

# Echelles à câbles

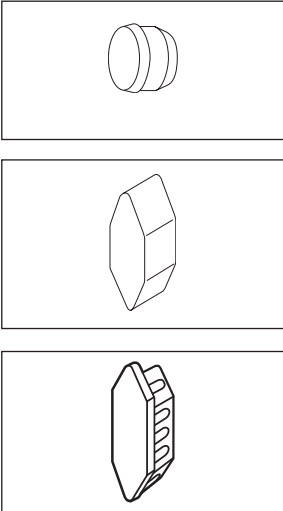
	type	référence	page catal.	groupe d'articles	prix en €	
	<b>Accouplement d'assemblage 20J</b>					
	Acier galvanisé à chaud	20J	713173	74	1313	35,64/pc.
						
	<b>Renfort 1</b>					
	Acier galvanisé à chaud	1/ 300	717640	75	1313	26,76/pc.
		1/ 500	717641	75	1313	35,26/pc.
		1/ 800	717642	75	1313	52,53/pc.
						
	<b>Renfort 1</b>					
	Acier galvanisé à chaud	1/ 1500	718903	75	1313	158,09/pc.
	<b>Equerre 60/40</b>					
	Acier galvanisé à chaud	60/ 40	718904	75	1313	16,18/pc.
						
	<b>Accouplement 21</b>					
	Zinc+	21	795051	78	1313	13,33/pc.
						
	<b>Accouplement 21</b>					
	Acier galvanisé à chaud	21	791199	78	1313	15,93/pc.
						
	<b>Accouplement 21</b>					
	Acier inoxydable AISI 316L	21	725751	78	1305	sur demande
						
	<b>Accouplement 9</b>					
	Acier galvanisé Sendzimir	9	721115	79	1313	6,14/pc.
						
	<b>Accouplement 9</b>					
	Acier galvanisé à chaud	9	705304	79	1313	9,97/pc.
						
	<b>Boulon intermédiaire 29</b>					
	Acier galvanisé à chaud	29/ 200	705392	79	1313	22,43/pc.
		29/ 300	705394	79	1313	25,71/pc.
		29/ 400	705395	79	1313	27,61/pc.
		29/ 500	705396	79	1313	32,24/pc.
		29/ 600	705397	79	1313	32,76/pc.
						

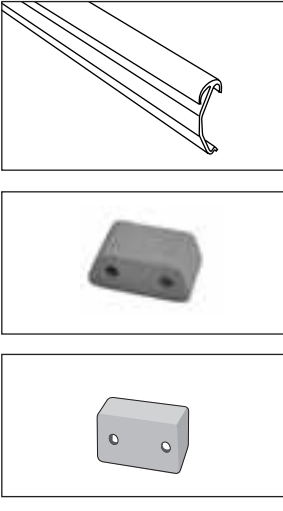
# Echelles à câbles

	type	référence	page catal.	groupe d'articles	prix en €	
	<b>Accouplement de branchement 32</b>					
	Acier galvanisé à chaud	32	734713	80	1313	79,06/pc.
						
	<b>Réduction 31</b>					
	Acier galvanisé à chaud	31/ 100	734171	80	1313	42,64/pc.
		31/ 200	734172	80	1313	52,27/pc.
		31/ 300	734173	80	1313	64,12/pc.
		31/ 400	734174	80	1313	73,94/pc.
						
	<b>Accouplement 22</b>					
	Acier galvanisé Sendzimir	22	721122	81	1313	15,73/pc.
						
	<b>Accouplement 22</b>					
	Acier galvanisé à chaud	22	718409	81	1313	23,91/pc.
						
	<b>Accouplement 22</b>					
	Acier inoxydable AISI 316L	22	725760	81	1305	sur demande
						
	<b>Dérivation fixe crochet 4</b>					
	Aluminium	4	709017	82	1313	15,18/pc.
						
	<b>Pied d'appui 10</b>					
	Aluminium	10	709018	82	1313	13,71/pc.
						
	<b>Etrier 41</b>					
	Acier galvanisé Sendzimir	41	725363	83	1313	15,00/pc.
						
	<b>Etrier 41</b>					
Acier galvanisé à chaud	41	720824	83	1313	23,96/pc.	
						
<b>Etrier 41</b>						
Acier inoxydable AISI 316L	41	783374	83	1305	sur demande	
						





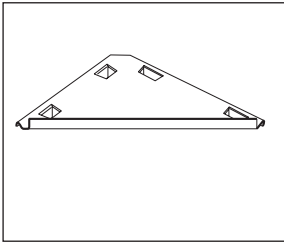
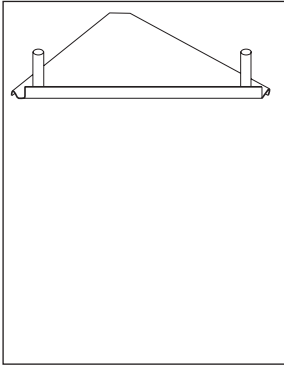
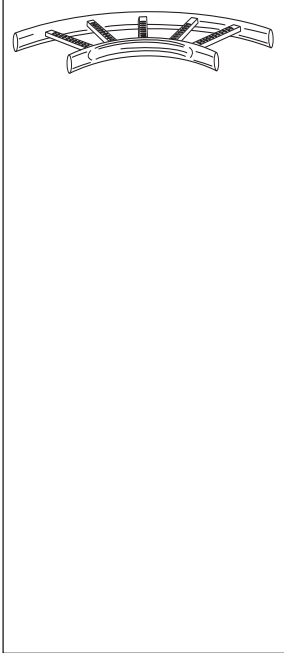
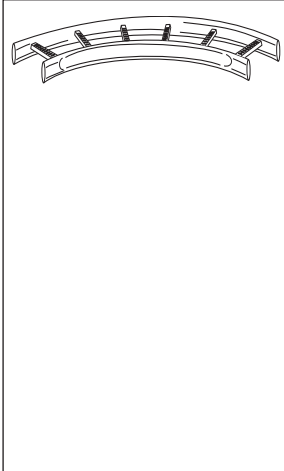
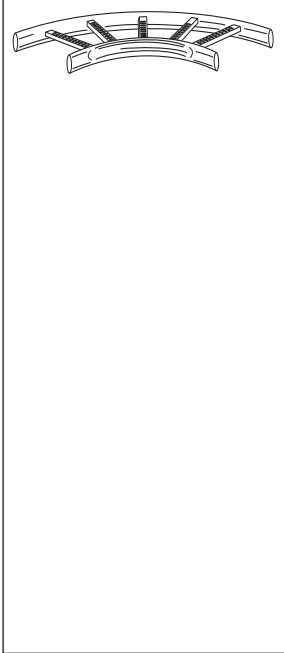
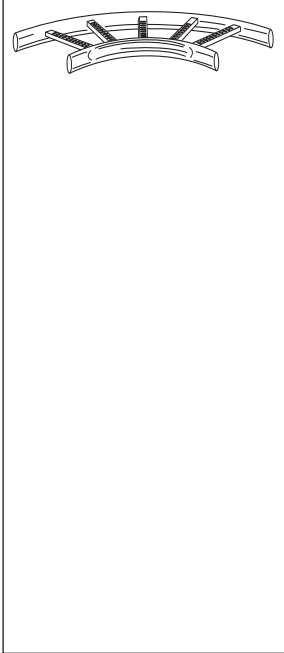
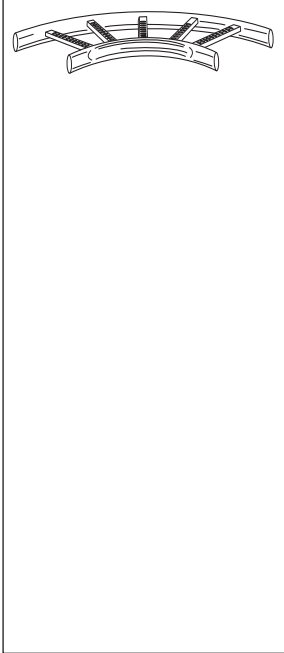
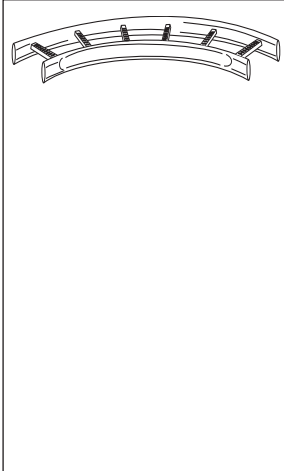
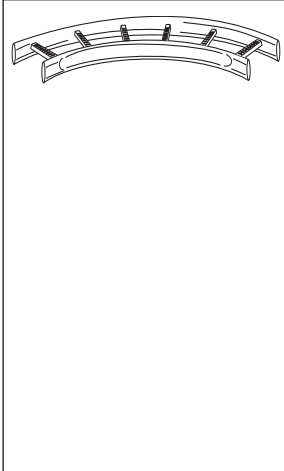

# Echelles à câbles

	type	référence	page catal.	groupe d'articles	prix en €	
	<b>Etrier mural</b>					
	Acier galvanisé Sendzimir	11/25 11/75	721105 721106	84 84	1313 1313	10,17/pc. 11,73/pc.
						
	<b>Etrier mural</b>					
	Acier galvanisé à chaud	11/25 11/75	713204 713203	84 84	1313 1313	15,22/pc. 15,86/pc.
						
	<b>Etrier mural</b>					
	Acier inoxydable AISI 316L	11/25 11/75	725774 725775	84 84	1305 1305	sur demande sur demande
						
	<b>Bouchon de protection 27</b>					
	Matière synthétique gris	27	726668	84	1313	0,99/pc.
						
	<b>Capuchon 28</b>					
	Matière synthétique orange	28	709019	85	1313	3,33/pc.
						
	<b>Capuchon 28i</b>					
	Matière synthétique blanc	28i	735446	85	1313	3,33/pc.
	Matière synthétique orange	28i	731994	85	1313	4,15/pc.
	<b>Profilé de protection 28P</b>					
	Matière synthétique gris	28P	732151	85	1313	27,90/m
	<b>Capuchon 28C</b>					
	Matière synthétique orange	28C	789875	86	1313	2,65/pc.
	Pour pendard 2 et profilé 24/34.					
	<b>Capuchon 28E</b>					
	Matière synthétique orange	28E	709021	86	1313	5,53/pc.
	Pour pendard 2F et 20F et profilé de suspension 24/48 et 24/20F.					
	<b>Capuchon 28D</b>					
	Matière synthétique orange	28D	709020	86	1313	6,06/pc.
	Pour pendard 20 et profilé de suspension 24/20.					
	<b>Capuchon 28F</b>					
	Matière synthétique orange	28F	789876	86	1313	6,86/pc.
	Pour pendard 20FS et profilé de suspension 24/20FS.					

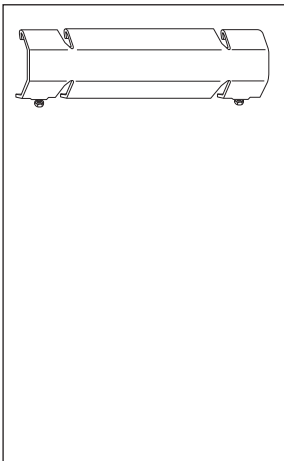
# Echelles à câbles

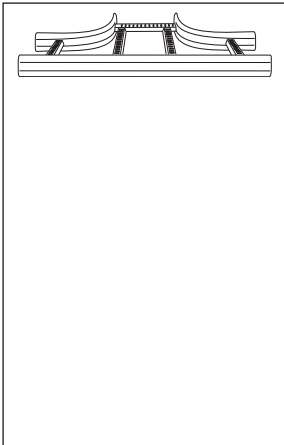

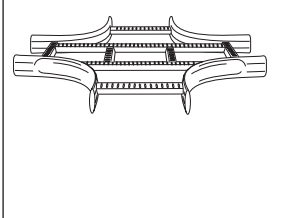
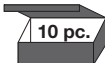
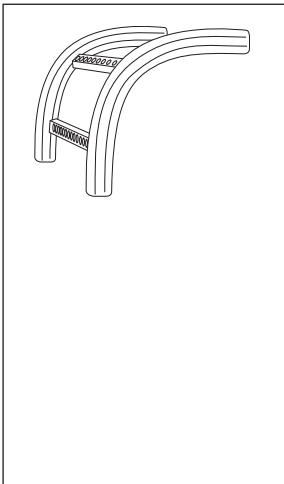

	type	référence	page catal.	groupe d'articles	prix en €	
	<b>Cornière 33/1</b>					
	Acier galvanisé Sendzimir	33/ 1	768733	86	1313	13,04/pc.
	<b>Cornière 33/1</b>					
	Acier inoxydable AISI 316L	33/ 1	727340	86	1305	sur demande
	<b>Cornière 33/2</b>					
	Acier galvanisé Sendzimir	33/ 2	721114	86	1313	68,30/pc.
	<b>Cornière 33/2</b>					
	Acier galvanisé à chaud	33/ 2	707748	86	1313	99,27/pc.
	<b>Cornière 33/2</b>					
	Acier inoxydable AISI 316L	33/ 2	727197	86	1305	sur demande
	<b>Courbe intérieure 90°,15</b>					
	Acier galvanisé Sendzimir	15/ 200	723061	87	1313	150,67/pc.
		15/ 300	723062	87	1313	159,89/pc.
		15/ 400	723063	87	1313	162,77/pc.
		15/ 500	723064	87	1313	191,05/pc.
		15/ 600	723065	87	1313	198,25/pc.
	<b>Courbe intérieure 90°,15</b>					
	Acier galvanisé à chaud	15/ 150	716066	87	1313	204,60/pc.
		15/ 200	716067	87	1313	204,60/pc.
		15/ 300	716069	87	1313	217,07/pc.
	15/ 400	716070	87	1313	219,24/pc.	
	15/ 500	716071	87	1313	234,46/pc.	
	15/ 600	716072	87	1313	248,78/pc.	
	15/ 800	721961	87	1313	443,64/pc.	
	15/ 1000	716073	87	1313	512,20/pc.	
	<b>Courbe intérieure 90°,15</b>					
	Acier inoxydable AISI 316L	15/ 150	727346	87	1305	sur demande
		15/ 200	727347	87	1305	sur demande
		15/ 300	727348	87	1305	sur demande
		15/ 400	727349	87	1305	sur demande
		15/ 500	727350	87	1305	sur demande
	15/ 600	727351	87	1305	sur demande	
	<b>Courbe extérieure 90°, 15</b>					
	Acier galvanisé à chaud	15/ 150	716179	87	1313	299,12/pc.
		15/ 200	716180	87	1313	320,07/pc.
		15/ 300	716182	87	1313	343,23/pc.
		15/ 400	716183	87	1313	373,33/pc.
		15/ 500	716184	87	1313	409,28/pc.
		15/ 600	716185	87	1313	415,22/pc.
		15/ 800	723057	87	1313	591,41/pc.
		15/ 1000	723260	87	1313	812,13/pc.
		<b>Courbe extérieure 90°, 15</b>				
Acier inoxydable AISI 316L		15/ 150	727352	87	1305	sur demande
		15/ 200	727353	87	1305	sur demande
		15/ 300	727354	87	1305	sur demande
		15/ 400	727355	87	1305	sur demande
		15/ 500	727356	87	1305	sur demande
	15/ 600	727357	87	1305	sur demande	

# Echelles à câbles



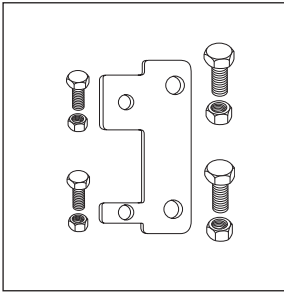
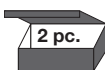

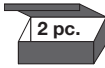
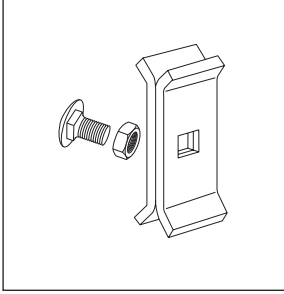
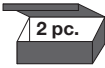
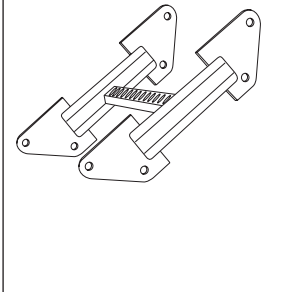
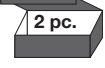
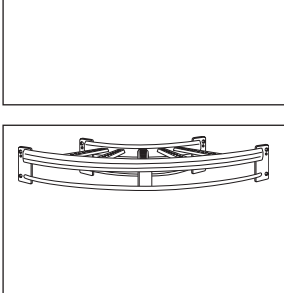
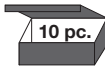

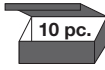
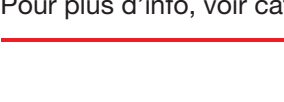

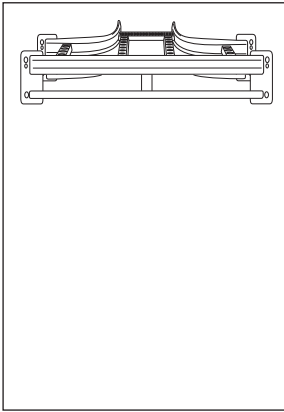
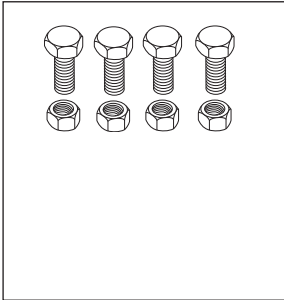

	type	référence	page catal.	groupe d'articles	prix en €
	<b>Accouplement 14</b>				
	Acier galvanisé Sendzimir	14	723212	88	1313 40,71/pc.
	 10 pc.				
	<b>Accouplement 14</b>				
	Acier galvanisé à chaud	14	725096	88	1313 64,12/pc.
	 10 pc.				
	<b>Accouplement 14</b>				
	Acier inoxydable AISI 316L	14	727195	88	1305 sur demande
	 10 pc.				
	<b>Pièce en T 16</b>				
	Acier galvanisé à chaud	16/ 150	716193	88	1313 221,97/pc.
		16/ 200	716194	88	1313 225,38/pc.
		16/ 300	716196	88	1313 233,58/pc.
		16/ 400	716197	88	1313 248,60/pc.
		16/ 500	716198	88	1313 253,40/pc.
		16/ 600	716199	88	1313 268,43/pc.
	16/ 1000	716200	88	1313 617,42/pc.	
	<b>Pièce en T 16</b>				
	Acier inoxydable AISI 316L	16/ 150	727358	88	1305 sur demande
		16/ 200	727359	88	1305 sur demande
		16/ 300	727360	88	1305 sur demande
		16/ 400	727361	88	1305 sur demande
		16/ 500	727362	88	1305 sur demande
		16/ 600	727363	88	1305 sur demande
	<b>Croisillon 17</b>				
	Acier galvanisé à chaud	17/ 150	716209	89	1313 346,29/pc.
		17/ 200	716210	89	1313 347,66/pc.
		17/ 300	716212	89	1313 355,84/pc.
		17/ 400	716213	89	1313 368,13/pc.
		17/ 500	716214	89	1313 376,33/pc.
		17/ 600	716215	89	1313 387,26/pc.
	17/ 1000	716216	89	1313 545,72/pc.	
	<b>Pièce de montée 18</b>				
	Acier galvanisé à chaud	18/ 150	718176	90	1313 231,57/pc.
		18/ 200	718177	90	1313 241,72/pc.
		18/ 300	718179	90	1313 247,69/pc.
		18/ 400	718180	90	1313 261,96/pc.
		18/ 500	718181	90	1313 265,95/pc.
		18/ 600	718182	90	1313 275,13/pc.
		18/ 800	721964	90	1313 336,73/pc.
		18/ 1000	718183	90	1313 357,04/pc.
		<b>Pièce de montée 18</b>			
Acier inoxydable AISI 316L		18/ 150	727370	90	1305 sur demande
		18/ 200	727371	90	1305 sur demande
		18/ 300	727372	90	1305 sur demande
		18/ 400	727373	90	1305 sur demande
		18/ 500	727374	90	1305 sur demande
	<b>Courbe en S 67</b>				
	Acier galvanisé à chaud	67	788638	91	1313 104,82/pc.

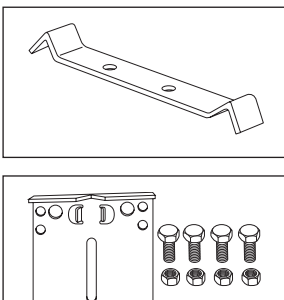

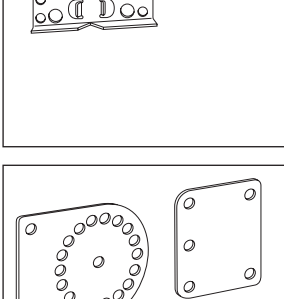

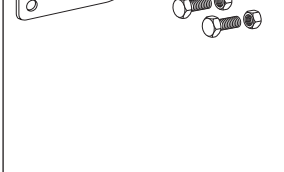



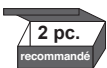

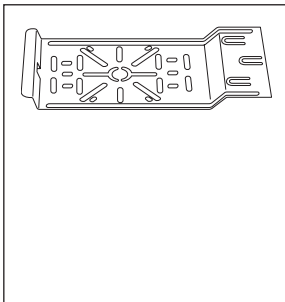
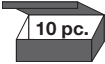
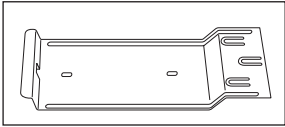
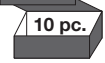

# Echelles à câbles

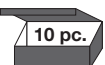
	type	référence	page catal.	groupe d'articles	prix en €	
	<b>Accouplement 45</b>					
	Acier galvanisé à chaud	45	707609	92	1313	65,22/pc.
	 2 pc.					
	<b>Accouplement 45</b>					
	Acier inoxydable AISI 316L	45	792873	92	1305	sur demande
	 2 pc.					
	<b>Dérivation crochet 47</b>					
	Acier galvanisé à chaud	47	791350	92	1313	46,27/pc.
	 2 pc.					
	<b>Dérivation crochet 47</b>					
	Acier inoxydable AISI 316L	47	792875	92	1305	sur demande
	 2 pc.					
	<b>Soutien pour profilé 46</b>					
	Acier galvanisé à chaud	46	708001	93	1313	20,38/pc.
	 10 pc.					
	<b>Soutien pour profilé 46</b>					
	Acier inoxydable AISI 316L	46	792877	93	1305	sur demande
	 10 pc.					
	<b>Pièce de montée 49</b>					
	Acier galvanisé à chaud	49/ 200	716389	93	1313	218,32/pc.
		49/ 300	716390	93	1313	222,38/pc.
		49/ 400	716391	93	1313	224,28/pc.
		49/ 500	720517	93	1313	225,25/pc.
		49/ 600	716392	93	1313	225,25/pc.
		49/ 1000	716393	93	1313	257,22/pc.
	<b>Pièce de montée 49</b>					
	Acier inoxydable AISI 316L	49/ 200	792880	93	1305	sur demande
		49/ 300	792881	93	1305	sur demande
		49/ 400	792882	93	1305	sur demande
		49/ 500	792883	93	1305	sur demande
		49/ 600	792884	93	1305	sur demande
		49/ 1000	792885	93	1305	sur demande
	<b>Courbe 90°, 55</b>					
	Acier galvanisé à chaud	55/ 200	716241	94	1313	402,98/pc.
		55/ 300	716243	94	1313	414,59/pc.
		55/ 400	716244	94	1313	424,82/pc.
		55/ 500	716245	94	1313	443,95/pc.
		55/ 600	716246	94	1313	445,98/pc.
		55/ 1000	716247	94	1313	753,34/pc.
	<b>Courbe 90°, 55</b>					
	Acier inoxydable AISI 316L	55/ 200	792903	94	1305	sur demande
		55/ 300	792904	94	1305	sur demande
		55/ 400	792905	94	1305	sur demande
		55/ 500	792906	94	1305	sur demande
		55/ 600	792907	94	1305	sur demande
		55/ 1000	792908	94	1305	sur demande

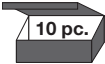

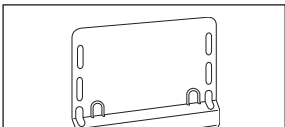

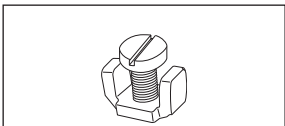
# Echelles à câbles

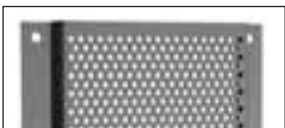
	type	référence	page catal.	groupe d'articles	prix en €	
	<b>Pièce en T 56</b>					
	Acier galvanisé à chaud	56/ 200	716255	94	1313	566,88/pc.
		56/ 300	716257	94	1313	580,54/pc.
		56/ 400	716258	94	1313	590,12/pc.
		56/ 500	716259	94	1313	606,48/pc.
		56/ 600	716260	94	1313	607,17/pc.
		56/ 1000	716261	94	1313	990,35/pc.
	<b>Pièce en T 56</b>					
	Acier inoxydable AISI 316L	56/ 200	792920	94	1305	sur demande
		56/ 300	792921	94	1305	sur demande
		56/ 400	792922	94	1305	sur demande
	56/ 500	792923	94	1305	sur demande	
	56/ 600	792924	94	1305	sur demande	
	<b>Boulonnerie M12</b>					
	Acier galvanisé à chaud	M12	706415	95	1313	12,49/set
						
	<b>Boulonnerie M12</b>					
	Acier inoxydable AISI 316L	M12	728767	95	1305	sur demande
						
	<b>Etrier 200 pour luminaire</b>					
	Acier galvanisé à chaud	200	718643	95	1313	32,24/pc.
						
	<b>Accouplement 44</b>					
	Acier galvanisé à chaud	44	720815	96	1313	88,74/pc.
						
	<b>Accouplement 44</b>					
	Acier inoxydable AISI 316L	44	792888	96	1305	sur demande
						
	<b>Accouplement 51</b>					
	Acier galvanisé à chaud	51	731837	97	1313	138,48/pc.
						
	<b>Accouplement 51</b>					
	Acier inoxydable AISI 316L	51	731914	97	1305	sur demande
						



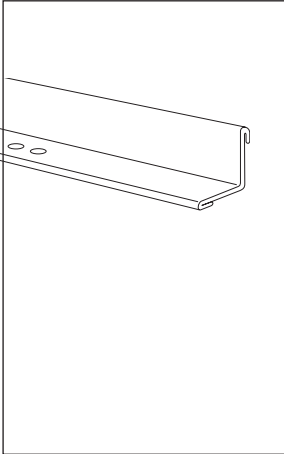
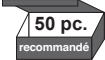
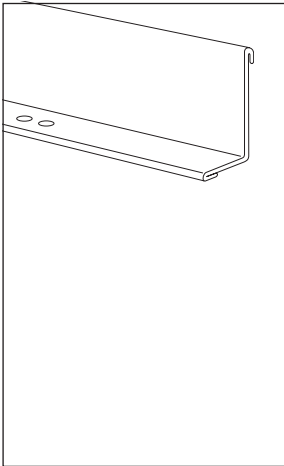
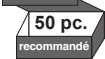
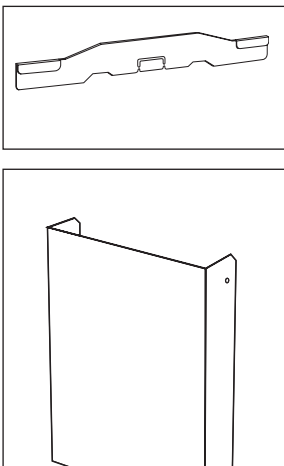
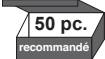
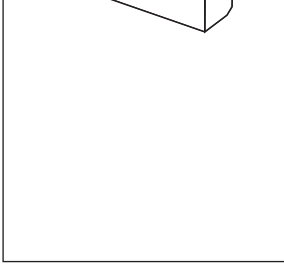



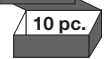
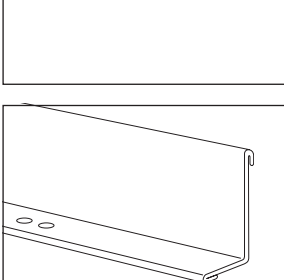
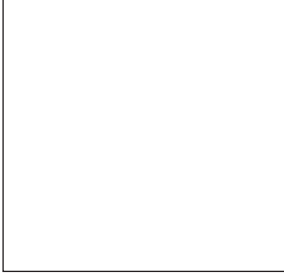



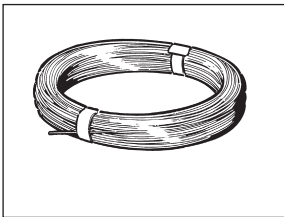

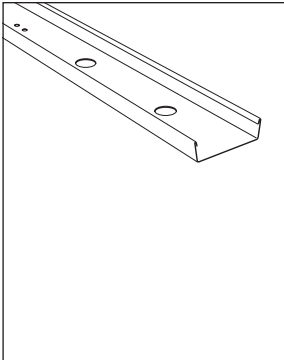

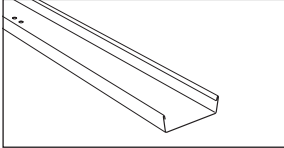
# Echelles à câbles

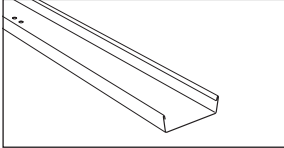
	type	référence	page catal.	groupe d'articles	prix en €
	<b>Plaque de montage 35P</b>				
	Acier galvanisé Sendzimir	35P	718618	98	1313
	 10 pc.				
	<b>Plaque de montage 35P</b>				
	Acier galvanisé à chaud	35P	731745	98	1313
	 10 pc.				
	<b>Plaque de montage 35S</b>				
	Acier galvanisé Sendzimir	35S	711205	99	1313
	 10 pc.				
	<b>Plaque de montage 35S</b>				
	Acier galvanisé à chaud	35S	731746	99	1313
	 10 pc.				
	<b>Plaque de montage 35S</b>				
	Acier inoxydable AISI 316L	35S	725776	99	1305
	 10 pc.				
	<b>Plaque de montage 35S</b>				
	Acier galvanisé Sendzimir	35S	730245	99	1313
	 10 pc.				
	<b>Borne de terre W79</b>				
	Acier à zingage électrolytique	W79	716640	99	1313
	 100 pc.				
	<b>Plaque de montage 62</b>				
	Acier galvanisé Sendzimir	62/100 62/200	783460 783461	100 100	1313 1313

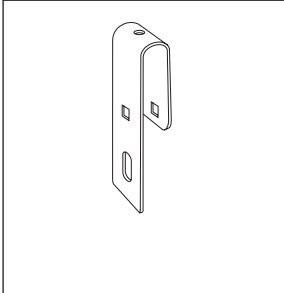
# Echelles à câbles

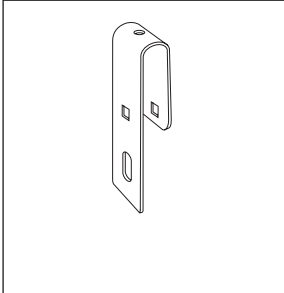

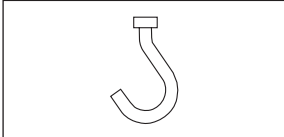
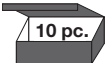
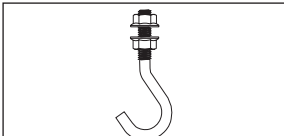
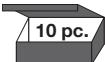
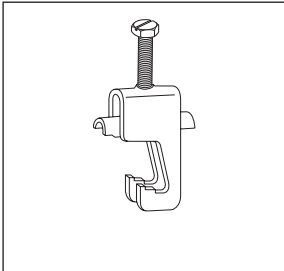





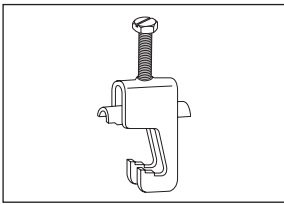

	type	référence	page catal.	groupe d'articles	prix en €	
	<b>Cloison de séparation 39</b>					
	Acier galvanisé Sendzimir	H=24 L=1,75m	718835	103	1313	10,94/pc.
						
	<b>Cloison de séparation 39</b>					
	Acier galvanisé à chaud	H=24 L=1,75m	731747	103	1313	17,53/pc.
						
	<b>Cloison de séparation 39</b>					
	Acier inoxydable AISI 316L	H=24 L=1,75m	725593	103	1305	sur demande
						
	<b>Cloison de séparation 39</b>					
	Acier galvanisé Sendzimir	H=55 L=1,75m	725785	103	1313	11,98/pc.
						
	<b>Cloison de séparation 39</b>					
	Acier galvanisé à chaud	H=55 L=1,75m	732983	103	1313	20,65/pc.
						
	<b>Cloison de séparation 39</b>					
	Acier inoxydable AISI 316L	H=55 L=1,75m	725594	103	1305	sur demande
						
	<b>Accouplement W39 pour cloison de séparation 39</b>					
	Matière synthétique	W39	716824	103	1313	5,37/pc.
						
	<b>Plaque de protection 65</b>					
	Acier galvanisé Sendzimir	200	732475	104	1313	238,77/pc.
	L=1m	300	732476	104	1313	247,43/pc.
		400	732477	104	1313	281,82/pc.
		500	732478	104	1313	301,14/pc.
		600	732479	104	1313	307,63/pc.
	<b>Plaque de protection 65</b>					
	Acier galvanisé à chaud	200	730192	104	1313	268,92/pc.
	L=1m	300	730193	104	1313	279,65/pc.
		400	730194	104	1313	311,91/pc.
		500	730195	104	1313	344,23/pc.
		600	730196	104	1313	381,89/pc.
	<b>Plaque de protection 65</b>					
	Acier inoxydable AISI 316L	200	732481	104	1305	sur demande
	L=1m	300	732482	104	1305	sur demande
		400	732483	104	1305	sur demande
		500	732484	104	1305	sur demande
		600	732485	104	1305	sur demande

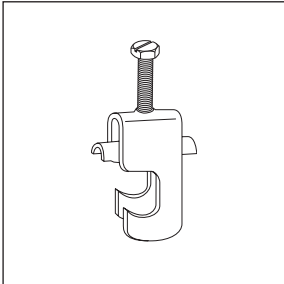
# Echelles à câbles

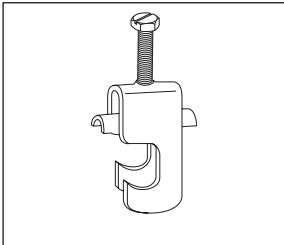

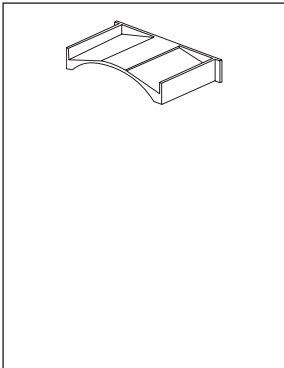



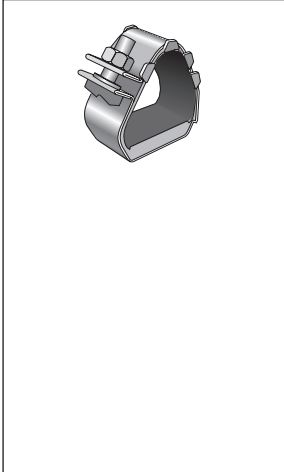
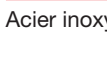

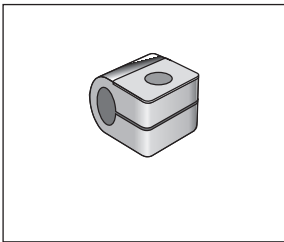

	type	référence	page catal.	groupe d'articles	prix en €	
	<b>Fil à nouer</b>					
	INOX, blanc PVC, ø 1,25 mm	HTR-2303	713686	105	1313	2,29/m
	INOX, noir PVC, ø 1,25 mm	HTR-2313	713687	105	1313	2,56/m
	blanc PVC, ø 1,5 mm	HTR-2304	713684	105	1313	0,77/m
	noir PVC, ø 1,5 mm	HTR-2314	713685	105	1313	0,77/m
						
	<b>Goulotte télé- et datacom 36</b>					
	Acier galvanisé Sendzimir	36/ 50	725065	106	1313	11,13/m
		36/ 100	725066	106	1313	12,13/m
		36/ 200	725067	106	1313	14,67/m
						
	<b>Goulotte télé- et datacom 36</b>					
	Acier galvanisé à chaud	36/ 50	731748	106	1313	16,18/m
		36/ 100	731749	106	1313	21,73/m
		36/ 200	731750	106	1313	31,17/m
						
	<b>Goulotte télé- et datacom 36</b>					
	Acier inoxydable AISI 316L	36/ 50	725590	106	1305	sur demande
		36/ 100	725591	106	1305	sur demande
		36/ 200	725592	106	1305	sur demande
						
	<b>Etrier 12/70 ou 12/120</b>					
	Acier galvanisé à chaud	12/ 70	728653	108	1313	28,77/pc.
		12/ 120	728654	108	1313	31,08/pc.
						
	<b>Etrier 12/70 ou 12/120</b>					
	Acier inoxydable AISI 316L	12/ 70	728651	108	1305	sur demande
		12/ 120	728652	108	1305	sur demande
						
	<b>Crochet 8</b>					
	Acier galvanisé à chaud		728642	108	1313	12,88/pc.
						
	<b>Crochet 8</b>					
	Acier inoxydable AISI 316L		728643	108	1305	sur demande
						
	<b>Pince à câbles, type A, pour 1 câble</b>					
	Acier galvanisé Sendzimir	A1 - 12	718507	109	1313	4,14/pc.
		A1 - 16	718508	109	1313	4,47/pc.
		A1 - 22	718509	109	1313	4,53/pc.
		A1 - 28	718510	109	1313	4,87/pc.
		A1 - 36	718511	109	1313	5,08/pc.
		A1 - 44	718512	109	1313	5,26/pc.
		A1 - 52	718513	109	1313	5,48/pc.
		A1 - 60	718514	109	1313	5,54/pc.
		A1 - 70	718515	109	1313	6,53/pc.
						

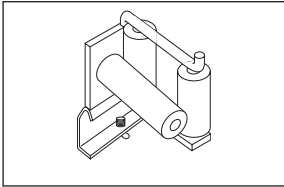
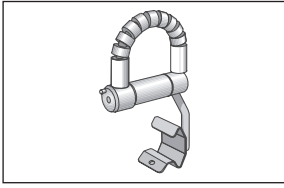

# Echelles à câbles

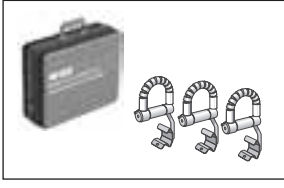
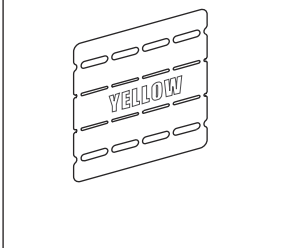
	type	référence	page catal.	groupe d'articles	prix en €		
	<b>Pince à câbles, type A, pour 2 câbles</b>						
		Acier galvanisé Sendzimir	A2 - 12	718516	109	1313	4,74/pc.
		A2 - 16	718517	109	1313	4,87/pc.	
		A2 - 22	718518	109	1313	5,07/pc.	
		A2 - 28	718519	109	1313	5,54/pc.	
		A2 - 36	718520	109	1313	6,59/pc.	
A2 - 44		718521	109	1313	7,20/pc.		
	<b>Pince à câbles, type R, pour 1 câble</b>						
		Acier galvanisé Sendzimir	R1 - 12	769000	110	1313	4,53/pc.
		R1 - 16	769001	110	1313	4,74/pc.	
		R1 - 22	769002	110	1313	4,87/pc.	
		R1 - 28	769003	110	1313	5,08/pc.	
		R1 - 36	769004	110	1313	5,48/pc.	
		R1 - 44	769005	110	1313	6,32/pc.	
		R1 - 52	769006	110	1313	6,53/pc.	
R1 - 60		769007	110	1313	7,20/pc.		
	<b>Pince à câbles, type R, pour 2 câbles</b>						
		Acier galvanisé Sendzimir	R2 - 12	769009	110	1313	4,47/pc.
		R2 - 16	769010	110	1313	4,53/pc.	
		R2 - 22	769011	110	1313	5,08/pc.	
		R2 - 28	769012	110	1313	5,13/pc.	
		R2 - 36	769013	110	1313	5,54/pc.	
		R2 - 44	769014	110	1313	5,93/pc.	
		R2 - 52	769015	110	1313	7,80/pc.	
R2 - 60		769016	110	1313	8,05/pc.		
	<b>Protège-câble EM</b>						
		Matière synthétique gris	EM - 12	709050	111	1313	2,42/pc.
		EM - 16	709051	111	1313	2,42/pc.	
		EM - 22	709052	111	1313	2,68/pc.	
		EM - 28	709053	111	1313	2,68/pc.	
		EM - 36	709054	111	1313	2,68/pc.	
		EM - 44	709055	111	1313	3,28/pc.	
		EM - 52	709056	111	1313	3,28/pc.	
		EM - 60	709057	111	1313	3,28/pc.	
		EM - 70	709058	111	1313	3,28/pc.	
	<b>Pince à câbles, type ER</b>						
		Acier inoxydable AISI 316	23 - 28	736440	112	1313	170,31/pc.
		27 - 32	736441	112	1313	173,75/pc.	
		30 - 35	736442	112	1313	175,92/pc.	
		33 - 38	736443	112	1313	178,25/pc.	
		36 - 42	736444	112	1313	189,73/pc.	
		40 - 46	736445	112	1313	193,21/pc.	
		44 - 50	736446	112	1313	196,64/pc.	
		48 - 55	736447	112	1313	215,98/pc.	
		51 - 58	736448	112	1313	219,45/pc.	
		55 - 62	736449	112	1313	222,82/pc.	
		59 - 66	736450	112	1313	254,76/pc.	
		63 - 70	736451	112	1313	258,24/pc.	
		67 - 74	736452	112	1313	261,66/pc.	
		71 - 78	736453	112	1313	291,48/pc.	
74 - 82		736454	112	1313	294,85/pc.		
77 - 85	736455	112	1313	297,10/pc.			

# Echelles à câbles

	type	référence	page catal.	groupe d'articles	prix en €
	<b>Adaptateur pour pince ER</b>				
	Acier inoxydable AISI 316	736456	112	1313	26,34/pc.
	Pour échelon rond set de montage 74S inclus.				
					
	<b>Boulonnerie 74S</b>				
	Acier inoxydable AISI 316	74S 737198	112	1313	10,02/pc.
	Deux sets sont nécessaire pour montage sur un échelon perforé.				
					
	<b>Enrouleuse de câbles S</b>				
	Acier galvanisé à chaud/ matière synthétique	S 718660	114	1313	440,81/pc.
	<b>Enrouleuse de câbles 38</b>				
	Acier inoxydable/ matière synthétique	38 735998	115	1313	440,81/pc.
	<b>Sac</b>				
	Matière synthétique	780186	115	1313	409,80/pc.
	<b>Set enrouleuses de câbles 66</b>				
	Set composé de 1 sac et 10 enrouleuses 38.	66 780187	115	1313	4577,17/set
	<b>Plaquette de marquage 93</b>				
	Acier, laqué				
	jaune, RAL 1018	93 737704	116	1313	27,96/pc.
	orange, RAL 2008	93 737705	116	1313	27,96/pc.
	bleu, RAL 5012	93 737706	116	1313	27,96/pc.
	vert, RAL 6032	93 737707	116	1313	27,96/pc.
	noir, RAL 9005	93 737708	116	1313	27,96/pc.
					
	<b>Anti-corrosion zinc "GALVAFROID"</b>				
	Pot 0,3 l	717637	116	1313	103,81/pc.
	<b>Peinture de retouche blanc</b>				
	Bombe	739713	116	1302	118,79/pc.

# Echelles à câbles



## Couvercle W5

	type	référence	page catal.	groupe d'articles	prix en €	
	Acier galvanisé Sendzimir	150	732216	117	1313	13,03/m
		200	732217	117	1313	16,01/m
		300	732218	117	1313	21,27/m
		400	732219	117	1313	31,13/m
		500	732220	117	1313	36,17/m
		600	732221	117	1313	49,83/m
		1000	732222	117	1313	123,33/m

## Couvercle W5

	type	référence	page catal.	groupe d'articles	prix en €	
	Acier galvanisé à chaud	150	732264	117	1313	32,33/m
		200	732265	117	1313	33,34/m
		300	732266	117	1313	42,33/m
		400	732267	117	1313	54,34/m
		500	732268	117	1313	55,34/m
		600	732269	117	1313	66,35/m
		1000	732270	117	1313	146,67/m

## Couvercle W5

	type	référence	page catal.	groupe d'articles	prix en €	
	Acier inoxydable AISI 316L	150	732291	117	1305	sur demande
		200	732292	117	1305	sur demande
		300	732293	117	1305	sur demande
		400	732294	117	1305	sur demande
		500	732295	117	1305	sur demande
		600	732296	117	1305	sur demande

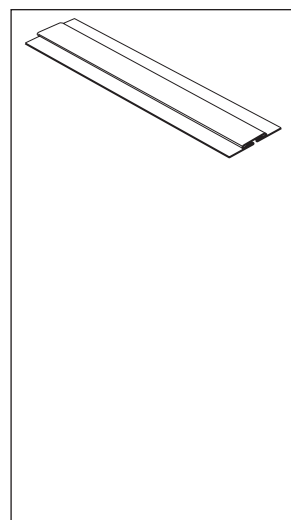

## Raccord de couvercle

	type	référence	page catal.	groupe d'articles	prix en €	
	Acier galvanisé Sendzimir	150	712639	118	1313	14,60/pc.
		200	712640	118	1313	15,82/pc.
		300	712642	118	1313	16,08/pc.
		400	712643	118	1313	18,90/pc.
		500	712644	118	1313	22,76/pc.
		600	712645	118	1313	24,36/pc.

## Raccord de couvercle

	type	référence	page catal.	groupe d'articles	prix en €	
	Acier galvanisé à chaud	150	780452	118	1313	36,42/pc.
		200	780453	118	1313	38,12/pc.
		300	780454	118	1313	41,55/pc.
		400	780455	118	1313	43,33/pc.
		500	780456	118	1313	46,79/pc.
		600	780457	118	1313	48,52/pc.

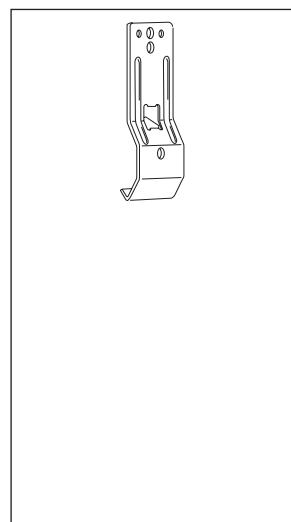

## Support de couvercle 37

	type	référence	page catal.	groupe d'articles	prix en €
	Acier galvanisé Sendzimir	729217	119	1313	6,12/pc.







## Support de couvercle 37

	type	référence	page catal.	groupe d'articles	prix en €
	Acier galvanisé à chaud	730188	119	1313	7,99/pc.

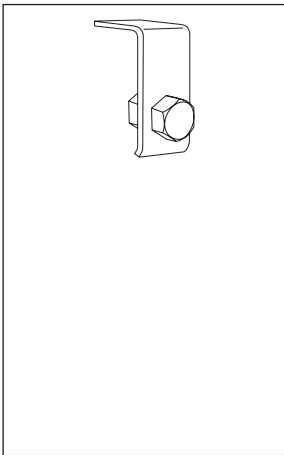
## Support de couvercle 37

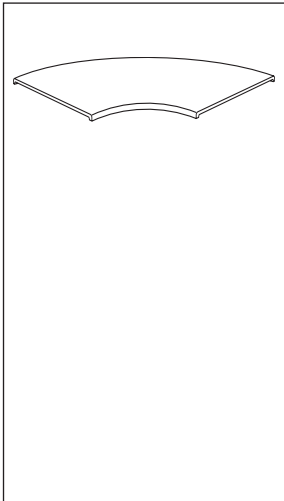

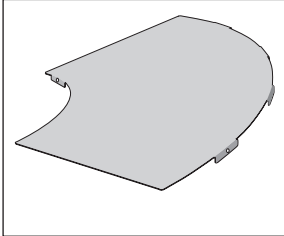

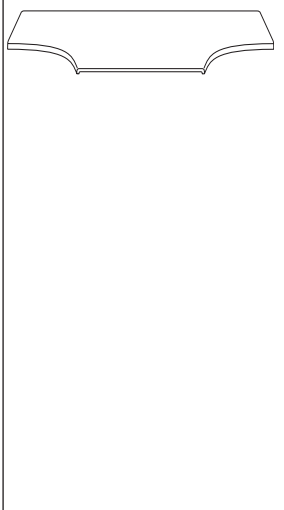
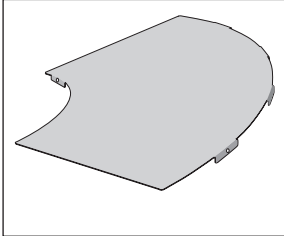
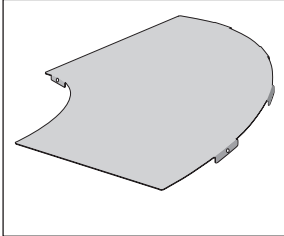
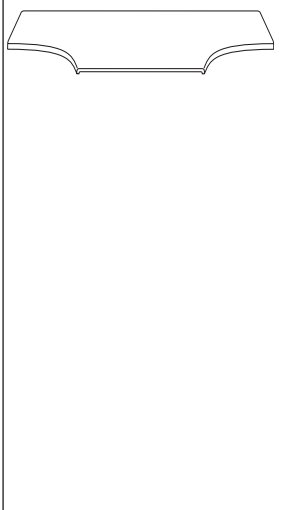
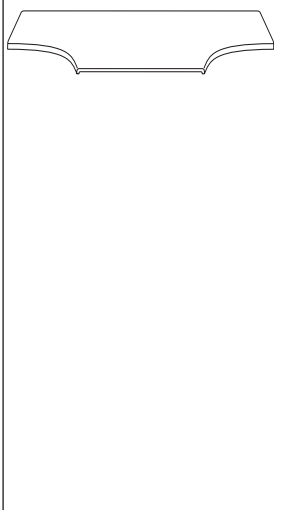





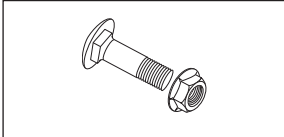

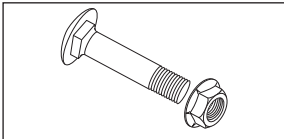
	type	référence	page catal.	groupe d'articles	prix en €
	Acier inoxydable AISI 316L	730190	119	1305	sur demande

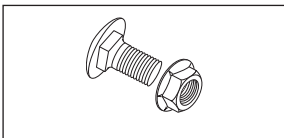
# Echelles à câbles

	type	référence	page catal.	groupe d'articles	prix en €	
	<b>Etrier de couvercle</b>					
	Acier galvanisé Sendzimir	712668	119	1313	6,33/pc.	
						
	<b>Etrier de couvercle</b>					
	Acier galvanisé à chaud	728584	119	1313	7,98/pc.	
						
	<b>Etrier de couvercle</b>					
	Acier inoxydable AISI 316L	728586	119	1305	sur demande	
						
	<b>Couvercle courbe 90°</b>					
	Acier galvanisé Sendzimir	150	732322	120	1313	139,67/pc.
		200	732323	120	1313	154,50/pc.
		300	732324	120	1313	178,78/pc.
		400	732325	120	1313	218,32/pc.
		500	732326	120	1313	260,21/pc.
		600	732327	120	1313	281,82/pc.
	<b>Couvercle courbe 90°</b>					
	Acier galvanisé à chaud	150	781433	120	1313	111,00/pc.
		200	781434	120	1313	139,29/pc.
		300	781435	120	1313	156,72/pc.
		400	781436	120	1313	194,89/pc.
		500	781437	120	1313	207,00/pc.
		600	781438	120	1313	235,77/pc.
	<b>Couvercle courbe 90°</b>					
	Acier inoxydable AISI 316L	150	788639	120	1305	sur demande
		200	788640	120	1305	sur demande
		300	788641	120	1305	sur demande
		400	788642	120	1305	sur demande
		500	788643	120	1305	sur demande
		600	788644	120	1305	sur demande
	<b>Couvercle pièce en T</b>					
	Acier galvanisé Sendzimir	150	732345	121	1313	156,42/pc.
		200	732346	121	1313	190,42/pc.
		300	732347	121	1313	207,38/pc.
		400	732348	121	1313	222,48/pc.
		500	732349	121	1313	258,18/pc.
		600	732350	121	1313	286,08/pc.
	<b>Couvercle pièce en T</b>					
	Acier galvanisé à chaud	150	781440	121	1313	137,14/pc.
		200	781441	121	1313	161,64/pc.
		300	781442	121	1313	194,36/pc.
		400	781443	121	1313	235,97/pc.
		500	781444	121	1313	285,93/pc.
		600	781445	121	1313	309,83/pc.

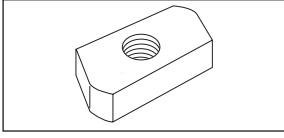

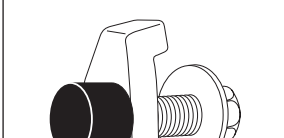
# Echelles à câbles

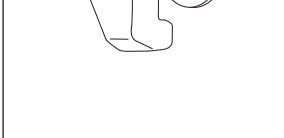
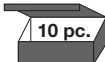
	type	référence	page catal.	groupe d'articles	prix en €
	<b>Couvercle pièce en T</b>				
	Acier inoxydable AISI 316L	150	788647	121	1305 sur demande
		200	788648	121	1305 sur demande
		300	788649	121	1305 sur demande
		400	788650	121	1305 sur demande
		500	788651	121	1305 sur demande
	600	788652	121	1305 sur demande	
	<b>Set de montage 2S</b>				
	Acier galvanisé à chaud	M8x40	715735	130	1313 1,55/pc.
					
	<b>Set de montage 20S</b>				
	Acier galvanisé à chaud	M8x60	715736	130	1313 2,02/pc.
					
	<b>Set de montage 22S</b>				
	Acier galvanisé à chaud	M8x16	713694	130	1313 0,98/pc.
		 			
	<b>Set de montage 22S</b>				
	Acier inoxydable AISI 316L	M8x16	725582	130	1305 sur demande
					
	<b>Ecroû couissant pour échelons perforés</b>				
	Acier galvanisé à chaud	M8	718632	131	1313 3,79/pc.
					
	<b>Boulon en T 26F</b>				
	Acier à zingage électrolytique	M8x30	734983	133	1313 5,99/pc.
		M10x30	734864	133	1313 6,08/pc.
					
	<b>Boulon en T 26F</b>				
	Acier galvanisé à chaud	M8x30	734744	133	1313 6,15/pc.
	M10x30	716794	133	1313 6,20/pc.	
	M10x40	716795	133	1313 8,19/pc.	
	M10x50	716796	133	1313 8,88/pc.	
					
	<b>Boulon en T 26F</b>				
	Acier inoxydable AISI 316L	M8x30	734986	133	1305 sur demande
		M10x30	728596	133	1305 sur demande
		M10x50	728598	133	1305 sur demande
					



KG 281

KG 281

KG 281

KB 184

W4

# Gaines à câbles KG 281

## Chemins de câbles KB 184

- ✓ La gamme la plus complète de gaines et chemins de câbles.
- ✓ Un choix étendu d'accessoires.
- ✓ Des raccordements sans vis, tels que des éclisses à boulonner, des ressorts d'accouplement, des verrous, des plaques de montage, etc. qui sont en outre faciles à monter et peu coûteux.
- ✓ Un choix étendu de fixations (encliquetables), adaptées à chaque sens de montage.
- ✓ Grâce au double rebord :
  - solidité renforcée ;
  - aucun risque d'endommagement du matériel ou de blessure ;
  - aucun endommagement lors de la pose de câbles.
- ✓ Esthétiquement les plus belles gaines/les plus beaux chemins de câbles :
  - élégants et jolis ;
  - disponibles en finition laquée, résistants aux rayures.









# Aperçu

KG281	KG281	KG281	KB184	W4
perforations latérales	perforations latérales / opercules défonçables	complètement fermé	perforé	perforé
				

## Caractéristiques

G.S.	✓	✓	✓	✓	✓
H.D.					✓
◀ mm	70-600	70-330	70-330	100-600	50-400
↕ mm	60	60	60	60	15
L mm	3000	3000	3000	3000	3000 (B ≤ 250) 1960 (B ≥ 300)

## Applications

 Tertiaire	✓	✓	✓	✓	✓
 Industrie				✓	✓
 Centres de données				✓	
 Installations PV				✓	✓
 Industrie alimentaire				✓	✓
 Pétrochimie				✓	✓
 G.S.	page 34	page 34	page 34	page 34	page 32
 H.D.	-	-	-	-	page 33

G.S.  
H.D.

galvanisation Sendzimir NBN EN 10346 – recommandé dans les environnements corrosifs C2 (faible)  
galvanisation à chaud NBN EN ISO 1461 – recommandé dans les environnements corrosifs C3/C4 (moyen/haut)



  
voir page 2

## Vue d'ensemble

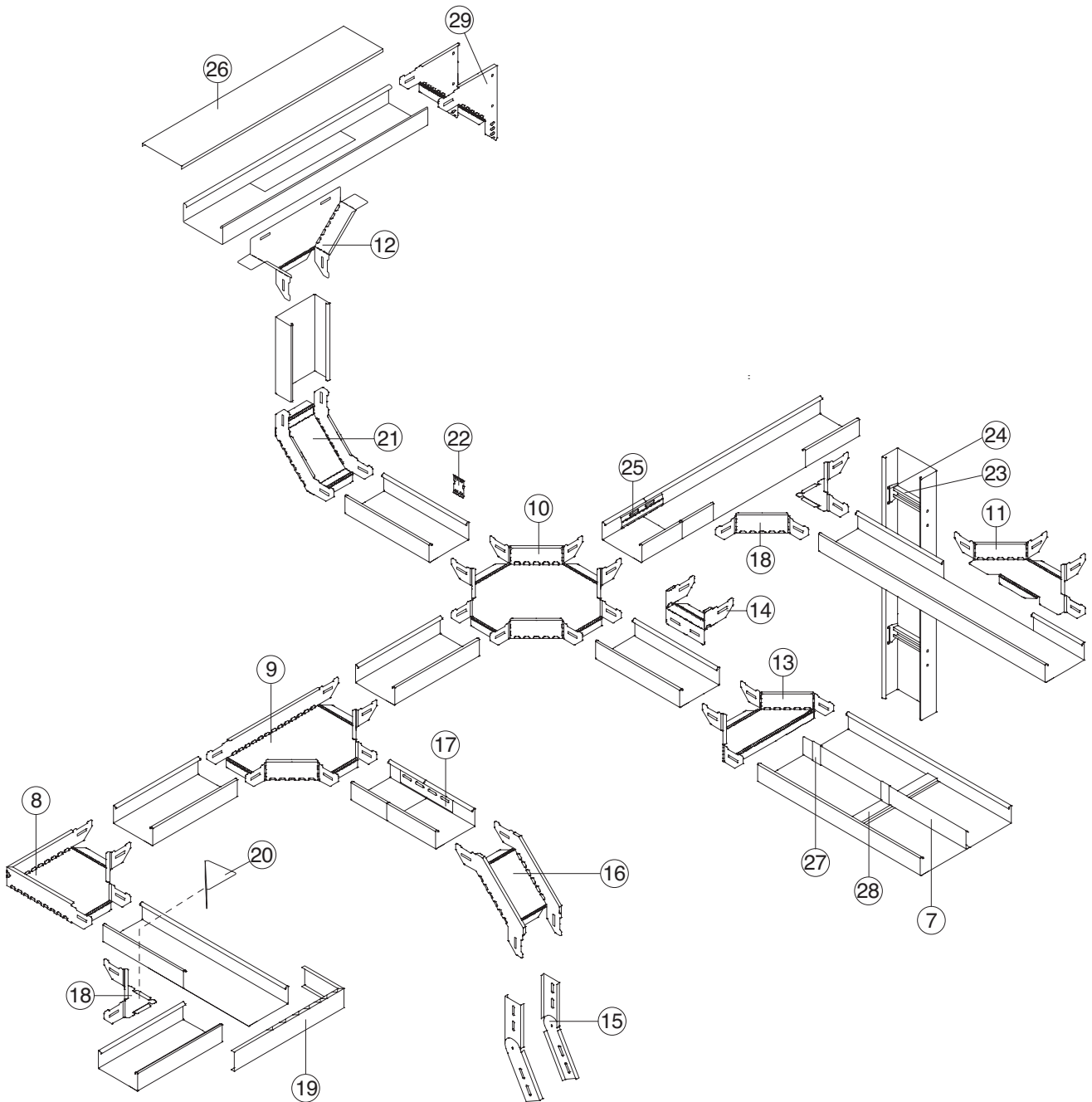
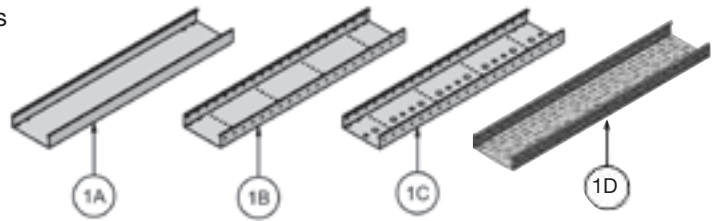
- 1A – Gaine à câbles KG 281 non perforée
- 1B – Gaine à câbles KG 281 avec perforations latérales
- 1C – Gaine à câbles KG 281 avec perforations latérales et opercules défonçables
- 1D – Chemin de câbles KB 184

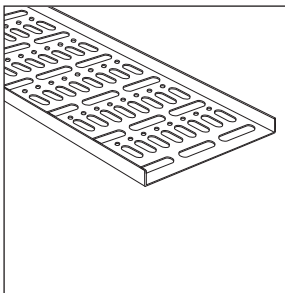
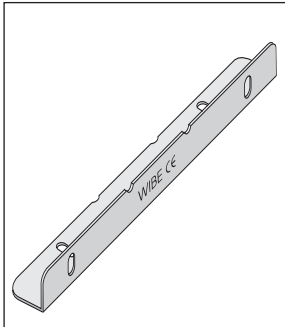
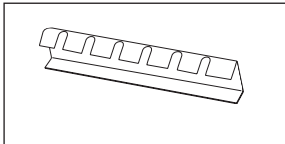

- |   |  |                                     |
|---|--|-------------------------------------|
| 7 - Cloison de séparation                 | 16 - Raccord de descente                   | 23 - Echelon                        |
| 8 - Pièce d'angle                         | 17 - Accouplement                          | 24 - Fixation pour échelon          |
| 9 - Pièce en T                            | 18 - Dérivation universelle                | 25 - Accouplement sans vis          |
| 10 - Croisillon                           | 19 - Accouplement / pièce de réduction     | 26 - Couvercle                      |
| 11 - Dérivation                           | 20 - Couvercle pour dérivation universelle | 27 - Verrou pour cloison            |
| 12 - Pièce murale verticale               | 21 - Raccord de montée                     | 28 - Etrier de fond                 |
| 13 - Réduction                            | 22 - Fixation pour accessoire              | 29 - Pièce en T verticale terminale |
| 14 - Dérivation surélevée                 |  |                                     |
| 15 - Raccord de descente: montée réglable |  |                                     |

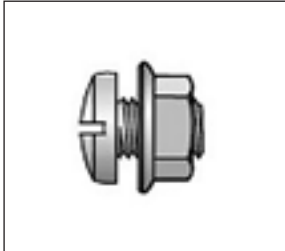
	type	référence	page catal.	groupe d'articles	prix en €	
	<b>Chemins de câbles W4</b>					
	Acier galvanisé Sendzimir	50	735988	46	1306	8,33/m
		75	735989	46	1306	10,88/m
		100	735990	46	1306	13,45/m
		150	735991	46	1306	16,23/m
		200	735992	46	1306	21,66/m
		250	735993	46	1306	28,07/m
		300	736609	46	1306	30,68/m
		400	736610	46	1306	38,21/m
	<b>Accouplement W2</b>					
	Acier galvanisé Sendzimir		788572	46	1306	5,20/pc.
	<b>Accouplement universel W4</b>					
	Acier galvanisé Sendzimir		70510		1306	2,63/pc.
	<b>Courbe 90° W4</b>					
	Acier galvanisé Sendzimir	50	784073	46	1306	39,20/pc.
		75	784074	46	1306	41,45/pc.
		100	784075	46	1306	43,69/pc.
		150	784076	46	1306	49,29/pc.
		200	784077	46	1306	56,57/pc.
		250	784078	46	1306	63,28/pc.
	<b>Pièce de montée/descente W4</b>					
	Acier galvanisé Sendzimir	50	784089	47	1306	43,13/pc.
		75	784090	47	1306	47,04/pc.
		100	784091	47	1306	48,73/pc.
		150	784092	47	1306	55,46/pc.
		200	784093	47	1306	63,28/pc.
		250	784094	47	1306	70,57/pc.
	<b>Set de montage W34</b>					
	Acier à zingage électrolytique	M6	718473	58	1306	1,12/pc.



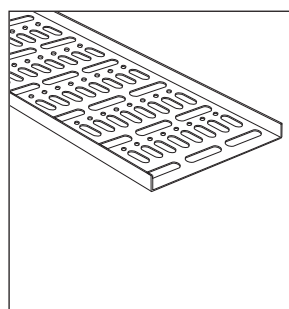

### Chemins de câbles W4

type	référence	page catal.	groupe d'articles	prix en €	
Acier galvanisé à chaud	50	735977	46	1306	11,27/m
	75	735978	46	1306	13,74/m
	100	735979	46	1306	18,04/m
	150	735980	46	1306	22,32/m
	200	735981	46	1306	31,18/m
	250	735982	46	1306	39,68/m
	300	736619	46	1306	44,30/m
	400	736620	46	1306	54,16/m

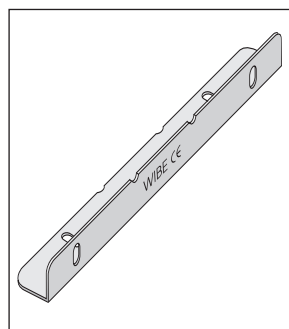

### Accouplement W2

type	référence	page catal.	groupe d'articles	prix en €
Acier galvanisé à chaud	788573	46	1306	6,16/pc.



### Courbe 90° W4

type	référence	page catal.	groupe d'articles	prix en €	
Acier galvanisé à chaud	50	784081	46	1306	43,69/pc.
	75	784082	46	1306	45,92/pc.
	100	784083	46	1306	48,73/pc.
	150	784084	46	1306	57,12/pc.
	200	784085	46	1306	258,44/pc.
	250	784086	46	1306	72,25/pc.
	300	784087	46	1306	86,81/pc.
	400	784088	46	1306	105,86/pc.



### Pièce de montée/descente W4

type	référence	page catal.	groupe d'articles	prix en €	
Acier galvanisé à chaud	50	784097	47	1306	47,61/pc.
	75	784098	47	1306	50,97/pc.
	100	784099	47	1306	53,20/pc.
	150	784100	47	1306	59,94/pc.
	200	784101	47	1306	69,45/pc.
	250	784102	47	1306	74,49/pc.
	300	784103	47	1306	85,13/pc.
400	784104	47	1306	108,09/pc.	



### Set de montage W38P

type	référence	page catal.	groupe d'articles	prix en €	
Dacromet	M6	733258	58	1306	1,34/pc.





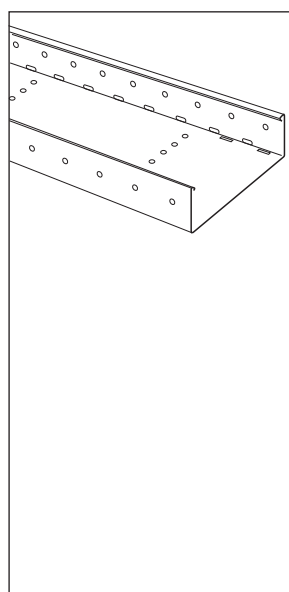

### Gaine à câbles KG281 à parois latérales perforées H=60 mm, épaisseur 0,8 mm

type	référence	page catal.	groupe d'articles	prix en €	
Acier galvanisé Sendzimir	70	8601202	24	1101	10,17/m
	120	8602202	24	1101	11,40/m
	200	8603202	24	1101	15,25/m
	250	8604202	24	1101	17,15/m



### Gaine à câbles KG281 à parois latérales perforées H=60 mm, épaisseur 1 mm

Acier galvanisé Sendzimir	70	8601204	24	1101	11,91/m
	120	8602204	24	1101	14,16/m
	200	8603204	24	1101	18,35/m
	250	8604204	24	1101	22,00/m
	330	8605204	24	1101	27,30/m
	400	8606204	24	1101	33,08/m



### Gaine à câbles KG281 à parois latérales perforées H=60 mm, épaisseur 1,25 mm

Acier galvanisé Sendzimir	500	8607205	24	1101	53,72/m
	600	8608205	24	1101	62,18/m

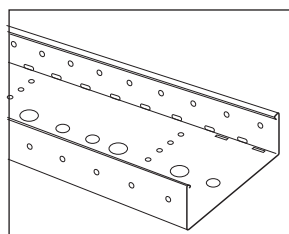

### Gaine à câbles KG281 à parois latérales perforées et avec opercules défonçables H=60 mm, E=1mm

Acier galvanisé Sendzimir	70	8601004	24	1101	12,50/m
	120	8602004	24	1101	14,84/m
	200	8603004	24	1101	19,28/m
	250	8604004	24	1101	23,10/m
	330	8605004	24	1101	28,66/m

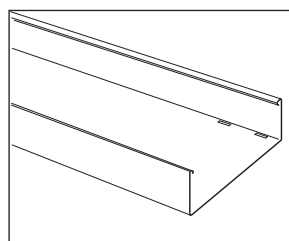

### Gaine à câbles KG281 non perforée H=60mm, épaisseur 1 mm

Acier galvanisé Sendzimir	70	8601404	24	1101	11,91/m
	120	8602404	24	1101	14,16/m
	200	8603404	24	1101	18,35/m
	250	8604404	24	1101	22,00/m
	330	8605404	24	1101	32,43/m



### Chemin de câbles KB 184, H = 60 mm, épaisseur 1 mm

Acier galvanisé Sendzimir	100	76011004	25	1102	13,48/m
	150	76011504	25	1102	16,01/m
	200	76012004	25	1102	18,35/m
	250	76012504	25	1102	22,00/m
	300	76013004	25	1102	24,05/m
	400	76014004	25	1102	31,23/m
	500	76015004	25	1102	43,05/m
	600	76016004	25	1102	49,58/m



### Chemin de câbles KB 184, H = 60 mm, épaisseur 1,25 mm









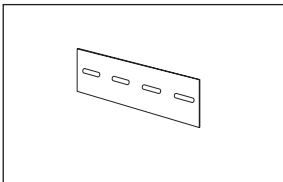
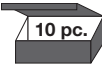

Acier galvanisé Sendzimir	300	76013005	25	1102	30,21/m
	400	76014005	25	1102	38,17/m
	500	76015005	25	1102	53,72/m
	600	76016005	25	1102	62,18/m

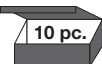



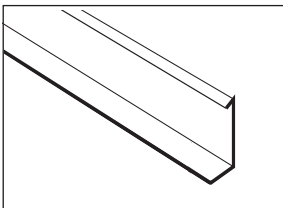

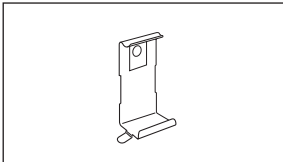
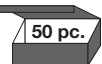
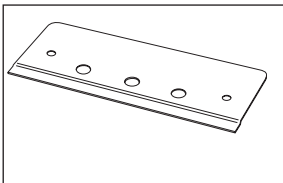



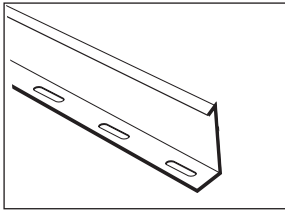

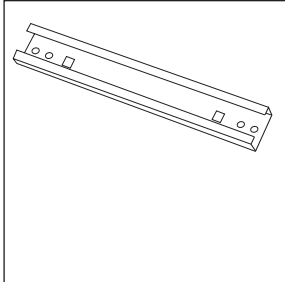
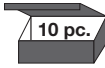
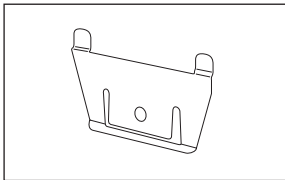
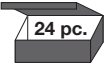
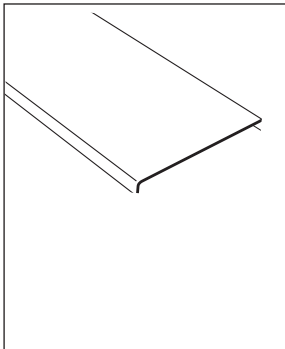

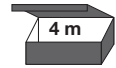
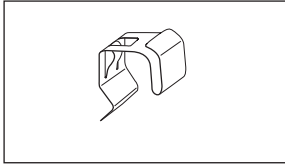
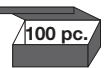
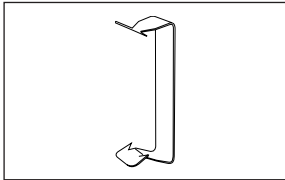
### Chemin de câbles KB 184, H = 60 mm, épaisseur 1,5 mm

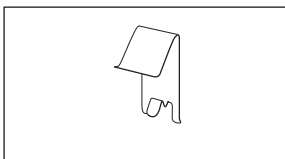
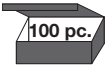
Acier galvanisé Sendzimir	100	76011006	25	1102	24,70/m
	200	76012006	25	1102	32,40/m
	300	76013006	25	1102	42,55/m
	400	76014006	25	1102	51,65/m
	500	76015006	25	1102	62,11/m
	600	76016006	25	1102	72,75/m

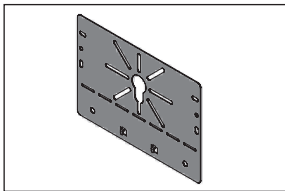
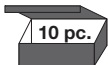
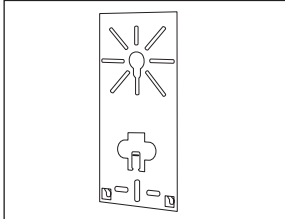
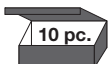
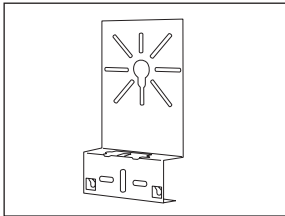

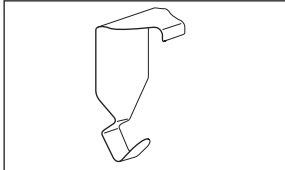
	type	référence	page catal.	groupe d'articles	prix en €	
	<b>Accouplement</b>					
	Acier galvanisé Sendzimir	200	80100	26	1101	1,51/pc.
						
	Accouplement d'accouplement pour toutes épaisseurs.					
	<b>Unilock</b>					
	Acier galvanisé Sendzimir		8010109	26	1101	1,51/pc.
						
	Accouplement sans vis pour épaisseurs 0,8 mm et 1 mm.					
	<b>Raccord de descente et de montée, H = 60 mm</b>					
	Acier galvanisé Sendzimir		8750000	37	1122	11,14/set
						
	Set pour les gaines à câbles KG281.					
	<b>Raccord de descente et de montée, H = 60 mm</b>					
	Acier galvanisé Sendzimir		76120009	37	1122	6,51/pc.
						
	Pour chemins de câbles KB 184.					
	<b>Cloison de séparation, H = 55 mm</b>					
	Acier galvanisé Sendzimir		88701	27	1101	5,99/m
						
	<b>Verrou pour cloison de séparation</b>					
	Acier galvanisé Sendzimir		88705	27	1101	0,48/pc.
						
	<b>Etrier de fond</b>					
	Acier galvanisé Sendzimir	70	88712	27	1101	5,60/pc.
		120	88722	27	1101	5,93/pc.
		200	88732	27	1101	6,40/pc.
		250	88742	27	1101	6,77/pc.
		330	88752	27	1101	7,73/pc.
						

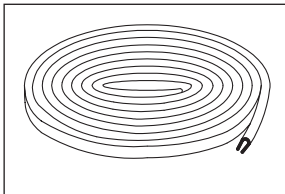
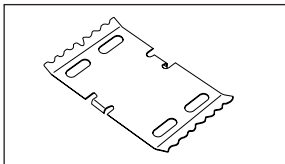
	type	référence	page catal.	groupe d'articles	prix en €	
	<b>Cloison de séparation, H = 55 mm</b>					
	Acier galvanisé Sendzimir	760200	28	1102	7,74/m	
						
	<b>Echelon</b>					
	Acier galvanisé Sendzimir	70	81512	28	1101	3,57/pc.
		120	81522	28	1101	4,34/pc.
		200	81532	28	1101	4,96/pc.
		250	81542	28	1101	5,71/pc.
		300	81550	28	1101	6,78/pc.
		330	81552	28	1101	6,92/pc.
		400	81562	28	1101	8,19/pc.
	500	81572	28	1101	8,90/pc.	
	600	81582	28	1101	10,50/pc.	
	<b>Fixation pour échelon</b>					
	Acier galvanisé Sendzimir	81504	28	1101	1,60/pc.	
						
	<b>Couvercle</b>					
	Acier galvanisé Sendzimir	70	8161003	29	1101	7,73/m
		100	8161103	29	1101	10,04/m
		120	8162003	29	1101	11,53/m
		150	8161503	29	1101	13,03/m
		200	8163003	29	1101	16,01/m
		250	8164003	29	1101	18,54/m
		300	8164303	29	1101	21,27/m
		330	8165004	29	1101	28,87/m
		400	8166004	29	1101	31,13/m
		500	8167004	29	1101	36,17/m
	600	8168004	29	1101	49,83/m	
	<b>Attache universelle</b>					
	Acier inoxydable	88550	29	1101	0,98/pc.	
						
	<b>Attache extérieure</b>					
	Acier inoxydable	H= 60mm	762400	29	1101	1,94/pc.
						
	<b>Attache</b>					
	Acier inoxydable	88520	29	1101	1,17/pc.	
						

	type	référence	page catal.	groupe d'articles	prix en €
	<b>Plaque de montage universelle</b> Acier galvanisé Sendzimir	8090109	30	1122	6,30/pc.
					
	<b>Plaque de montage plane</b> Acier galvanisé Sendzimir	8250109	30	1122	5,82/pc.
					
	<b>Plaque de montage emboutie</b> Acier galvanisé Sendzimir	8250209	30	1122	6,83/pc.
					
	<b>Ressort de serrage rapide pour plaque de montage</b> Acier inoxydable	88540	30	1122	0,36/pc.
					
	<b>Bande de protection</b> Matière synthétique/acier L = 5 m	8040000	30	1122	58,37/pc.
	<b>Fixation pour accessoire</b> Acier inoxydable	8856050	31	1122	1,11/pc.
					

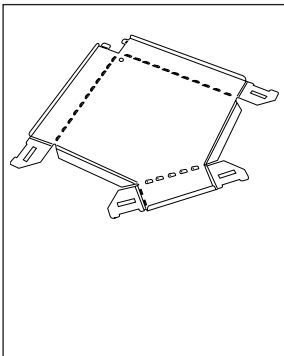
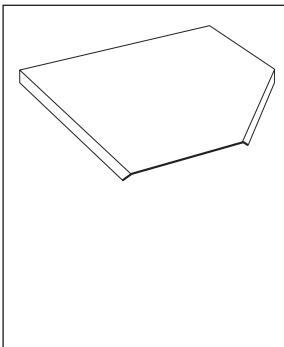
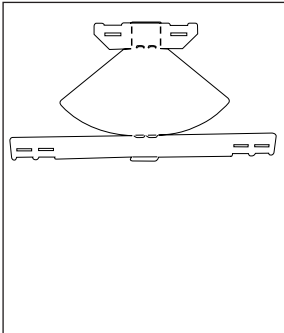
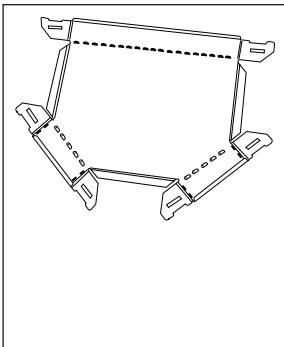
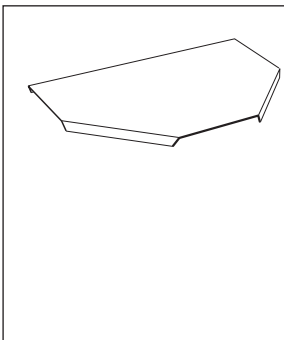
	type	référence	page catal.	groupe d'articles	prix en €	
	<b>Pièce d'angle, H = 60 mm</b>					
	Acier galvanisé Sendzimir	70	36060702	32	1122	23,55/pc.
		100	36061002	32	1122	24,78/pc.
	Livrée sous forme aplanie.	120	36061202	32	1122	25,32/pc.
		150	36061502	32	1122	26,15/pc.
		200	36062002	32	1122	28,09/pc.
		250	36062502	32	1122	34,35/pc.
		300	36063002	32	1122	41,55/pc.
		330	36063302	32	1122	45,19/pc.
		400	36064002	32	1122	53,69/pc.
	500	36065002	32	1122	67,84/pc.	
	600	36066002	32	1122	86,47/pc.	
	<b>Couvercle pour pièce d'angle</b>					
	Acier galvanisé Sendzimir	70	30060702	32	1122	9,62/pc.
		100	30061002	32	1122	10,54/pc.
		120	30061202	32	1122	11,53/pc.
		150	30061502	32	1122	13,74/pc.
		200	30062002	32	1122	14,34/pc.
		250	30062502	32	1122	16,86/pc.
		300	30063002	32	1122	23,42/pc.
		330	30063302	32	1122	24,14/pc.
		400	30064002	32	1122	31,36/pc.
	500	30065002	32	1122	43,78/pc.	
	600	30066002	32	1122	63,51/pc.	
	<b>Pièce d'angle réglable, H = 60 mm</b>					
	Acier galvanisé Sendzimir	70	36520702	32	1122	24,23/pc.
		100	36521002	32	1122	26,76/pc.
	Livrée sous forme aplanie.	120	36521202	32	1122	27,40/pc.
		150	36521502	32	1122	28,33/pc.
		200	36522002	32	1122	29,63/pc.
		250	36522502	32	1122	33,27/pc.
		300	36523002	32	1122	34,98/pc.
		330	36523302	32	1122	52,08/pc.
		400	36524002	32	1122	91,94/pc.
	500	36525002	32	1122	129,64/pc.	
	600	36526002	32	1122	151,59/pc.	
	<b>Pièce en T, H = 60 mm</b>					
	Acier galvanisé Sendzimir	70	36150702	32	1122	31,67/pc.
		100	36151002	32	1122	34,31/pc.
	Livrée sous forme aplanie.	120	36151202	32	1122	36,23/pc.
		150	36151502	32	1122	38,15/pc.
		200	36152002	32	1122	41,72/pc.
		250	36152502	32	1122	49,48/pc.
		300	36153002	32	1122	57,24/pc.
		330	36153302	32	1122	63,98/pc.
		400	36154002	32	1122	79,78/pc.
	500	36155002	32	1122	90,07/pc.	
	600	36156002	32	1122	109,61/pc.	
	<b>Couvercle pour pièce en T</b>					
	Acier galvanisé Sendzimir	70	30150702	33	1122	12,90/pc.
		100	30151002	33	1122	13,75/pc.
		120	30151202	33	1122	15,09/pc.
		150	30151502	33	1122	15,46/pc.
		200	30152002	33	1122	17,36/pc.
		250	30152502	33	1122	19,50/pc.
		300	30153002	33	1122	22,45/pc.
		330	30153302	33	1122	24,63/pc.
		400	30154002	33	1122	29,69/pc.
	500	30155002	33	1122	57,98/pc.	
	600	30156002	33	1122	70,80/pc.	

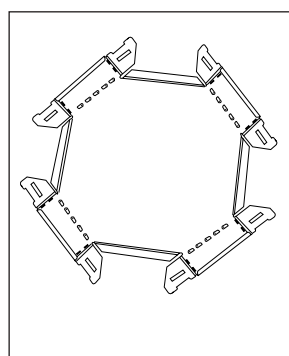

### Croisillon, H = 60 mm

	type	référence	page catal.	groupe d'articles	prix en €
Acier galvanisé Sendzimir	70	36160702	33	1122	49,67/pc.
	100	36161002	33	1122	50,56/pc.
Livrée sous forme aplanie.	120	36161202	33	1122	51,14/pc.
	150	36161502	33	1122	51,98/pc.
	200	36162002	33	1122	53,91/pc.
	250	36162502	33	1122	63,10/pc.
	300	36163002	33	1122	69,56/pc.
	330	36163302	33	1122	91,36/pc.
	400	36164002	33	1122	103,89/pc.
	500	36165002	33	1122	122,46/pc.
600	36166002	33	1122	150,08/pc.	

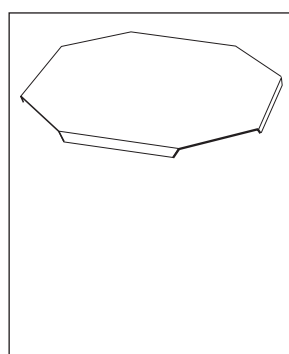

### Couvercle pour croisillon

Acier galvanisé Sendzimir	70	30160702	33	1122	21,53/pc.
	100	30161002	33	1122	23,33/pc.
	120	30161202	33	1122	24,50/pc.
	150	30161502	33	1122	25,46/pc.
	200	30162002	33	1122	27,96/pc.
	250	30162502	33	1122	31,01/pc.
	300	30163002	33	1122	34,89/pc.
	330	30163302	33	1122	37,81/pc.
	400	30164002	33	1122	44,69/pc.
	500	30165002	33	1122	53,66/pc.
	600	30166002	33	1122	64,38/pc.

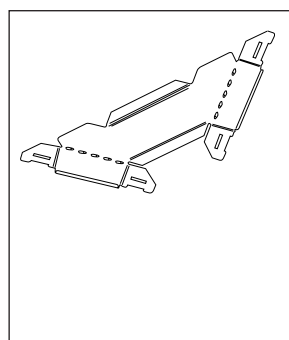

### Dérivation, H = 60 mm

Acier galvanisé Sendzimir	70	36070702	33	1122	16,76/pc.
	100	36071002	33	1122	17,84/pc.
Livrée sous forme aplanie.	120	36071202	33	1122	18,24/pc.
	150	36071502	33	1122	18,65/pc.
	200	36072002	33	1122	20,21/pc.
	250	36072502	33	1122	23,07/pc.
	300	36073002	33	1122	33,00/pc.
	330	36073302	33	1122	39,27/pc.
	400	36074002	33	1122	45,56/pc.
	500	36075002	33	1122	59,44/pc.
600	36076002	33	1122	59,74/pc.	

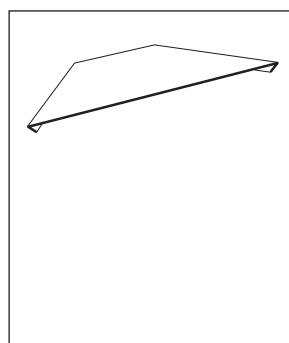

### Couvercle pour dérivation, H = 60 mm

Acier galvanisé Sendzimir	70	30070702	34	1122	7,49/pc.
	100	30071002	34	1122	7,98/pc.
	120	30071202	34	1122	9,47/pc.
	150	30071502	34	1122	10,93/pc.
	200	30072002	34	1122	12,28/pc.
	250	30072502	34	1122	14,60/pc.
	300	30073002	34	1122	15,82/pc.
	330	30073302	34	1122	18,62/pc.
	400	30074002	34	1122	21,55/pc.
	500	30075002	34	1122	24,50/pc.
	600	30076002	34	1122	30,21/pc.

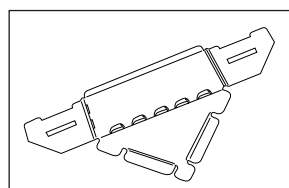

### Dérivation universelle, H = 60 mm

Acier galvanisé Sendzimir		36110002	34	1122	7,25/pc.
Livrée sous forme aplanie.					

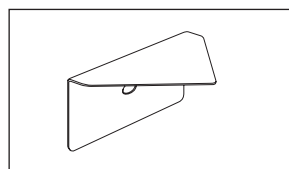

### Couvercle pour dérivation universelle

Acier galvanisé Sendzimir		8980000	34	1122	8,66/pc.
---------------------------	--	---------	----	------	----------

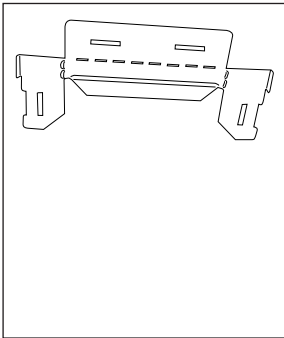
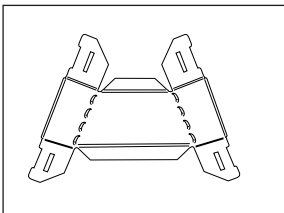
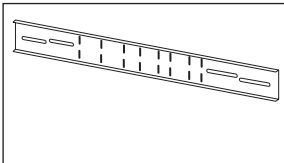
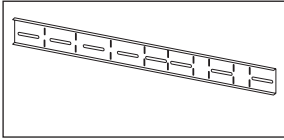
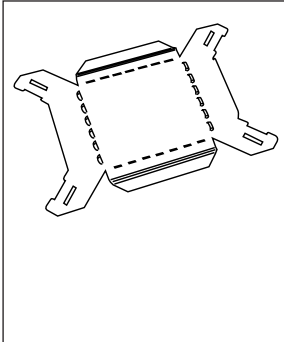
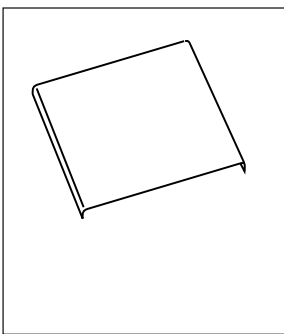

	type	référence	page catal.	groupe d'articles	prix en €	
	<b>Dérivation surélevée, H = 60 mm</b>					
	Acier galvanisé Sendzimir	70	36510702	35	1122	14,31/pc.
		100	36511002	35	1122	15,00/pc.
	Livrée sous forme aplanie.	120	36511202	35	1122	15,44/pc.
		150	36511502	35	1122	16,02/pc.
		200	36512002	35	1122	17,14/pc.
		250	36512502	35	1122	19,65/pc.
		300	36513002	35	1122	21,26/pc.
		330	36513302	35	1122	22,99/pc.
400		36514002	35	1122	27,90/pc.	
	<b>Réduction, H = 60 mm</b>					
	Acier galvanisé Sendzimir	70-120	36252202	35	1122	20,61/pc.
		70-200	36252402	35	1122	27,10/pc.
	Livrée sous forme aplanie.	70-250	36252602	35	1122	28,04/pc.
		120-200	36254702	35	1122	28,76/pc.
		120-250	36254802	35	1122	37,82/pc.
		200-250	36256402	35	1122	41,31/pc.
<b>Couvercle pour réduction</b>						
Acier galvanisé Sendzimir	70-120	30252202	35	1122	9,14/pc.	
	70-200	30252402	35	1122	10,44/pc.	
	70-250	30252602	35	1122	13,11/pc.	
	120-200	30254702	35	1122	11,82/pc.	
	120-250	30254802	35	1122	15,40/pc.	
	200-250	30256402	35	1122	15,72/pc.	
	<b>Accouplement / réduction, H = 60 mm</b>					
	Acier galvanisé Sendzimir	605	8940000	36	1122	8,33/pc.
	Pour jonctions angulaires jusqu'à 330 mm.					
	<b>Accouplement / réduction, H = 60 mm</b>					
	Acier galvanisé Sendzimir	957	8960000	36	1122	12,83/pc.
	Pour jonctions angulaires jusqu'à 600 mm.					
	<b>Raccord de montée, H = 60 mm</b>					
	Acier galvanisé Sendzimir	70	36230702	36	1122	18,40/pc.
		100	36231002	36	1122	20,21/pc.
	Livré sous forme aplanie.	120	36231202	36	1122	22,21/pc.
		150	36231502	36	1122	24,18/pc.
		200	36232002	36	1122	26,62/pc.
		250	36232502	36	1122	33,65/pc.
		300	36233002	36	1122	42,45/pc.
		330	36233302	36	1122	46,73/pc.
		400	36234002	36	1122	56,60/pc.
500		36235002	36	1122	68,40/pc.	
600		36236002	36	1122	74,10/pc.	
	<b>Couvercle pour raccord de montée</b>					
	Acier galvanisé Sendzimir	70	30230702	36	1122	9,62/pc.
		100	30231002	36	1122	10,11/pc.
		120	30231202	36	1122	11,18/pc.
		150	30231502	36	1122	13,02/pc.
		200	30232002	36	1122	14,34/pc.
		250	30232502	36	1122	18,12/pc.
		300	30233002	36	1122	21,53/pc.
		330	30233302	36	1122	22,45/pc.
		400	30234002	36	1122	28,33/pc.
		500	30235002	36	1122	33,85/pc.
	600	30236002	36	1122	43,49/pc.	

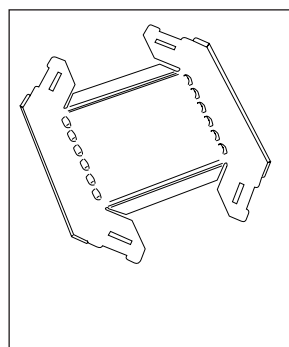

### Raccord de descente, H = 60 mm

	type	référence	page catal.	groupe d'articles	prix en €
Acier galvanisé Sendzimir	70	36220702	37	1122	18,40/pc.
	100	36221002	37	1122	20,21/pc.
Livré sous forme aplanie.	120	36221202	37	1122	22,21/pc.
	150	36221502	37	1122	24,18/pc.
	200	36222002	37	1122	26,62/pc.
	250	36222502	37	1122	33,65/pc.
	300	36223002	37	1122	42,45/pc.
	330	36223302	37	1122	46,73/pc.
	400	36224002	37	1122	56,60/pc.
	500	36225002	37	1122	68,40/pc.
	600	36226002	37	1122	74,10/pc.

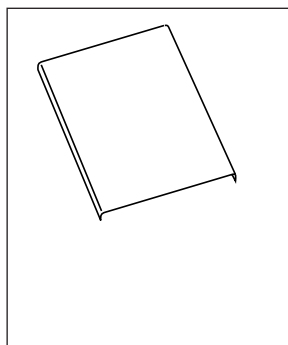

### Couvercle pour raccord de descente, H = 60 mm

	type	référence	page catal.	groupe d'articles	prix en €
Acier galvanisé Sendzimir	70	30220702	37	1122	9,62/pc.
	100	30221002	37	1122	10,32/pc.
	120	30221202	37	1122	11,18/pc.
	150	30221502	37	1122	12,52/pc.
	200	30222002	37	1122	14,34/pc.
	250	30222502	37	1122	18,12/pc.
	300	30223002	37	1122	20,33/pc.
	330	30223302	37	1122	22,45/pc.
	400	30224002	37	1122	28,33/pc.
	500	30225002	37	1122	33,85/pc.
	600	30226002	37	1122	43,49/pc.

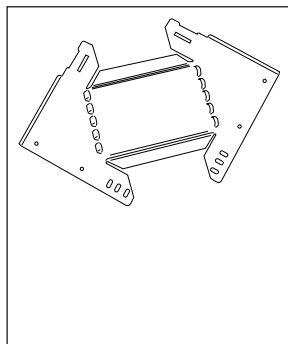

### Pièce en T verticale terminale, H = 60 mm

	type	référence	page catal.	groupe d'articles	prix en €
Acier galvanisé Sendzimir	70	36430702	37	1122	37,20/pc.
	100	36431002	37	1122	37,93/pc.
Livrée sous forme aplanie.	120	36431202	37	1122	38,42/pc.
	150	36431502	37	1122	46,99/pc.
	200	36432002	37	1122	47,98/pc.
	250	36432502	37	1122	51,68/pc.
	300	36433002	37	1122	52,07/pc.
	330	36433302	37	1122	52,58/pc.
	400	36434002	37	1122	57,37/pc.
	500	36435002	37	1122	62,78/pc.
	600	36436002	37	1122	65,48/pc.

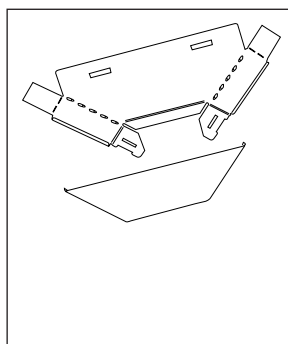

### Pièce murale verticale avec couvercle, H = 60 mm

	type	référence	page catal.	groupe d'articles	prix en €
Acier galvanisé Sendzimir	70	36240702	38	1122	61,30/pc.
	100	36241002	38	1122	61,61/pc.
Avec couvercle. Livrée sous forme aplanie.	120	36241202	38	1122	64,19/pc.
	150	36241502	38	1122	66,67/pc.
	200	36242002	38	1122	69,90/pc.
	250	36242502	38	1122	80,48/pc.
	300	36243002	38	1122	92,10/pc.
	330	36243302	38	1122	103,09/pc.
	400	36244002	38	1122	112,85/pc.
	500	36245002	38	1122	152,92/pc.
	600	36246002	38	1122	187,34/pc.

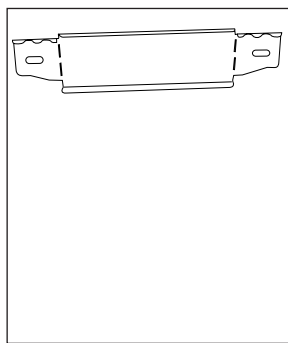

### Cloison terminale, H = 60 mm

	type	référence	page catal.	groupe d'articles	prix en €
Acier galvanisé Sendzimir	70	36180704	38	1122	5,60/pc.
	100	36181004	38	1122	5,89/pc.
Livrée sous forme aplanie.	120	36181204	38	1122	6,29/pc.
	150	36181504	38	1122	6,75/pc.
	200	36182004	38	1122	7,03/pc.
	250	36182504	38	1122	7,57/pc.
	300	36183004	38	1122	8,60/pc.
	330	36183304	38	1122	9,22/pc.
	400	36184004	38	1122	9,99/pc.
	500	36185004	38	1122	11,90/pc.
	600	36186004	38	1122	13,87/pc.





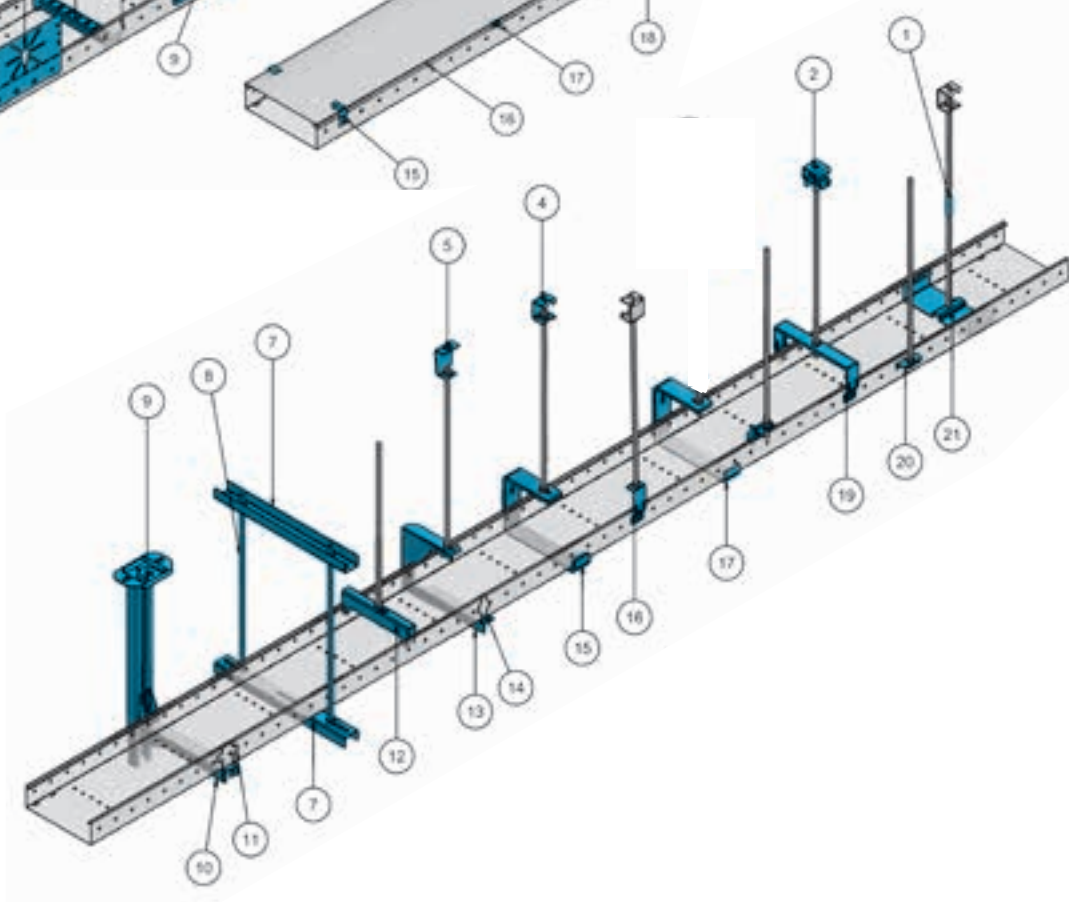
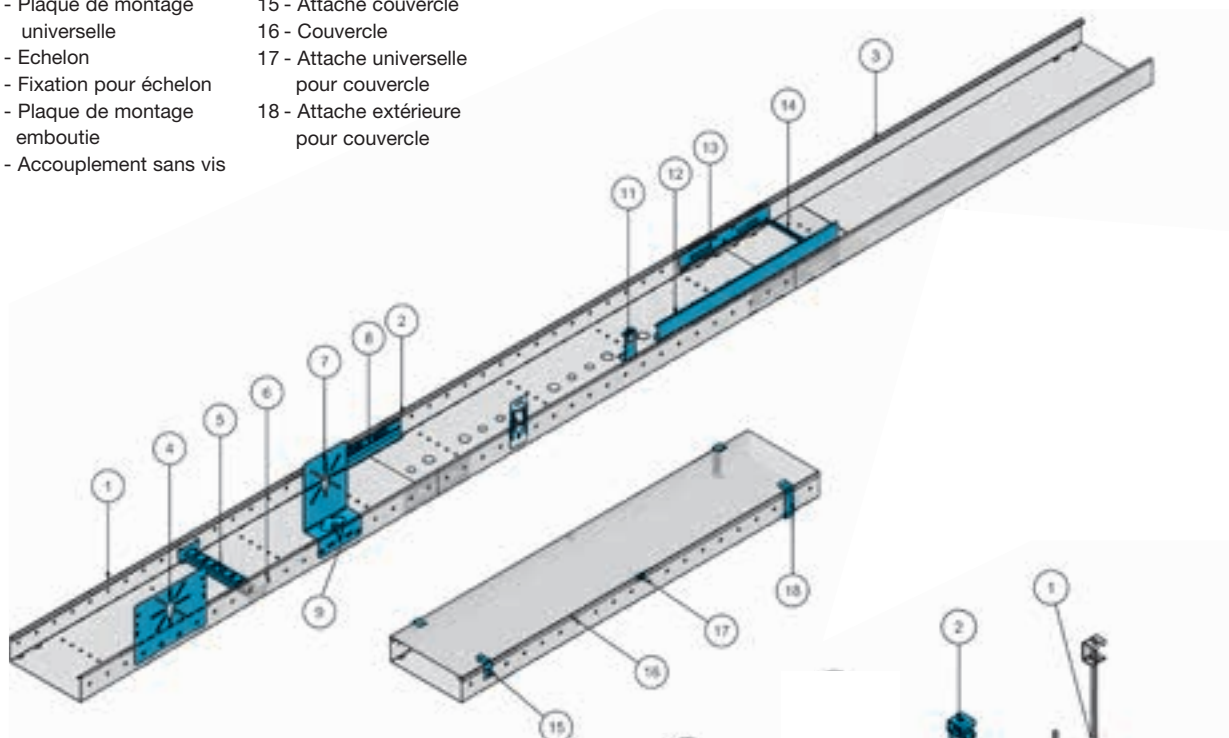





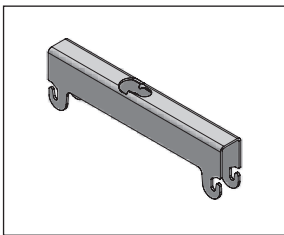

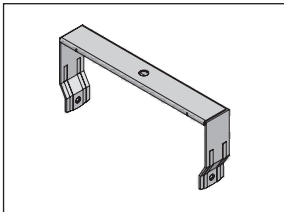
## Vue d'ensemble

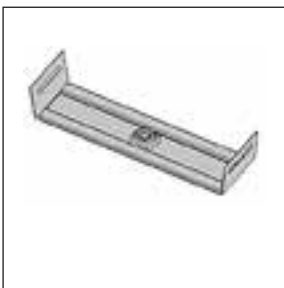
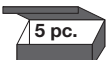
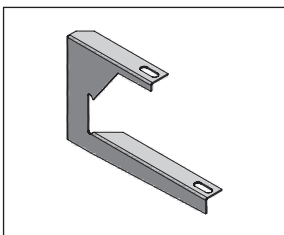
- |  |  |
|--|--|
| <ul style="list-style-type: none"> <li>1 - Gaine à câbles à parois latérales perforées</li> <li>2 - Gaine à câbles avec opercules défonçables</li> <li>3 - Gaine à câbles non perforées</li> <li>4 - Plaque de montage universelle</li> <li>5 - Echelon</li> <li>6 - Fixation pour échelon</li> <li>7 - Plaque de montage emboutie</li> <li>8 - Accouplement sans vis</li> </ul> | <ul style="list-style-type: none"> <li>9 - Fixation pour accessoire</li> <li>11 - Dispositif de verrouillage</li> <li>12 - Cloison de séparation</li> <li>13 - Accouplement</li> <li>14 - Etrier de fond</li> <li>15 - Attache couvercle</li> <li>16 - Couvercle</li> <li>17 - Attache universelle pour couvercle</li> <li>18 - Attache extérieure pour couvercle</li> </ul> |
|--|--|

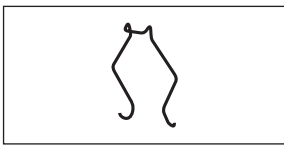



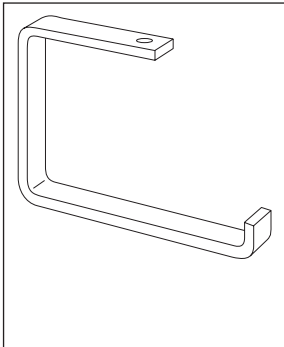

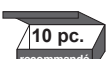
- |   |  |   |
|---|--|---|
| <ul style="list-style-type: none"> <li>1 - Ecrou de rallonge</li> <li>2 - Etrier de plafond</li> <li>4 - Etrier de plafond ouvert</li> <li>5 - Etrier de plafond</li> <li>7 - Profilé de support</li> <li>8 - Tige filetée M10</li> <li>9 - Pendard 2F</li> </ul> | <ul style="list-style-type: none"> <li>10 - Console 50i</li> <li>11 - Ressort</li> <li>12 - Etrier supérieur</li> <li>13 - Etrier en C extérieur</li> <li>14 - Ressort</li> <li>15 - Etrier en C</li> <li>16 - Etrier de suspension</li> <li>17 - Etrier en C</li> </ul> | <ul style="list-style-type: none"> <li>19 - Etrier supérieur pour porteur de câbles avec couvercle</li> <li>20 - Etrier pour perforation latérale</li> <li>21 - Etrier intérieur</li> </ul> |
|---|--|---|



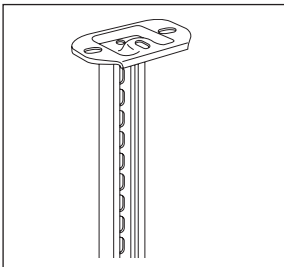
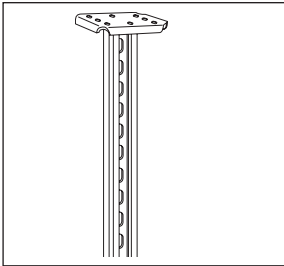

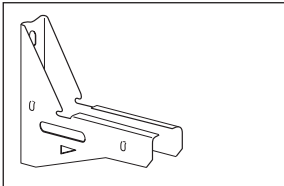
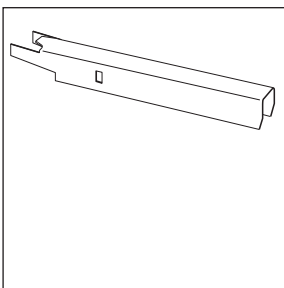
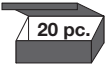
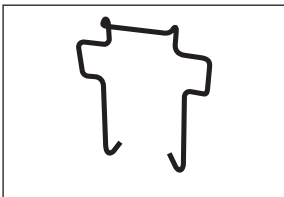
# Systemes de suspension – gaines et chemins de câbles

	type	référence	page catal.	groupe d'articles	prix en €	
	<b>Etrier supérieur</b>					
	Acier galvanisé Sendzimir	70	8101009	49	1127	4,10/pc.
		120	8112009	49	1127	4,96/pc.
		200	8123009	49	1127	7,06/pc.
		250	8134009	49	1127	7,98/pc.
		330	8135009	49	1127	10,52/pc.
	<b>Etrier supérieur</b>					
	Acier galvanisé Sendzimir	70	86510	49	1127	12,62/pc.
		120	86520	49	1127	14,82/pc.
		200	86530	49	1127	16,74/pc.
		250	86540	49	1127	18,12/pc.
	<b>Etrier intérieur avec écrou M10</b>					
	Acier galvanisé Sendzimir	70	8140709	49	1127	6,96/pc.
		100	8141009	49	1127	7,80/pc.
		120	8141209	49	1127	8,50/pc.
		150	8141509	49	1127	9,28/pc.
		200	8142009	49	1127	10,31/pc.
		250	8142509	49	1127	12,22/pc.
		300	8143009	49	1127	13,72/pc.
		330	8143309	49	1127	14,79/pc.
		<b>Etrier en C extérieur</b>				
Acier galvanisé Sendzimir		70	81710	50	1127	14,50/pc.
		120	81720	50	1127	15,92/pc.
		200	81730	50	1127	21,55/pc.
		250	81740	50	1127	25,75/pc.
Deux pièces ressorts 84400 à commander séparément.						
	<b>Ressort</b>					
	Acier inoxydable		84400	50	1127	1,41/pc.
						
	<b>Etrier en C</b>					
	Acier galvanisé Sendzimir	70	CEZ070	50	1504	7,24/pc.
		100	CEZ100	50	1504	7,76/pc.
		120	CEZ120	50	1504	8,10/pc.
		150	CEZ150	50	1504	11,14/pc.
		200	CEZ200	50	1504	12,39/pc.
		300	CEZ300	50	1504	19,13/pc.
		400	CEZ400	50	1504	25,01/pc.
	<b>Etrier en C</b>					
	Acier galvanisé à chaud	70	81712		1127	10,52/pc.
		100	81731		1127	11,21/pc.
		120	81722		1127	12,65/pc.
		150	81715		1127	14,82/pc.
		200	81732		1127	16,38/pc.
		250	81742		1127	22,13/pc.
		300	81733		1127	24,53/pc.
		330	81752		1127	28,90/pc.
		400	81762		1127	36,85/pc.

# Systemes de suspension – gaines et chemins de câbles

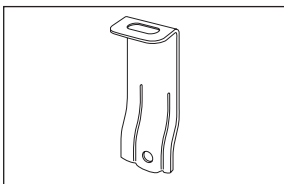
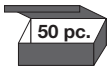
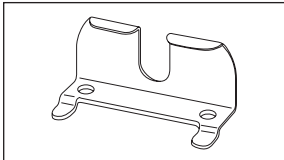
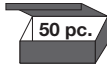
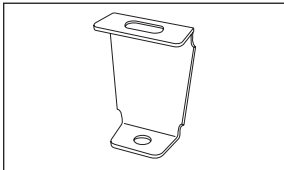
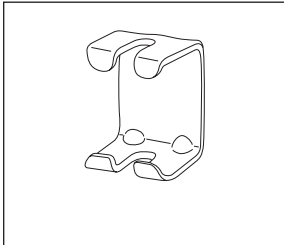
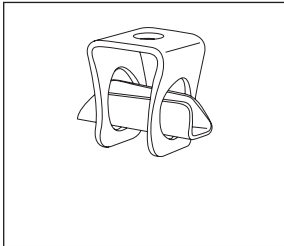

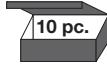

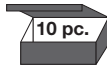





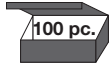
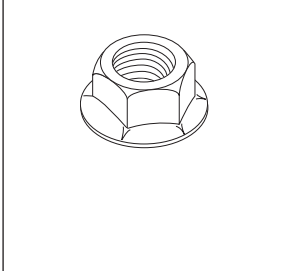

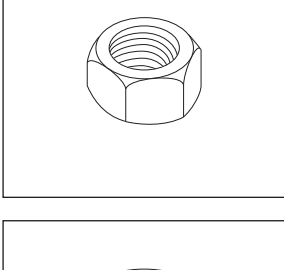

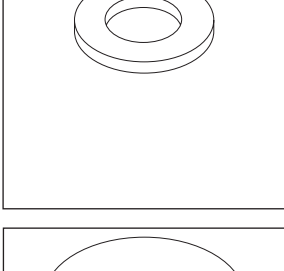
	type	référence	page catal.	groupe d'articles	prix en €	
	<b>Pendant simple 2F</b>					
	Acier galvanisé à chaud	2F/ 280	717196	51	1313	21,09/pc.
		2F/ 370	717197	51	1313	24,10/pc.
		2F/ 505	717198	51	1313	27,36/pc.
		2F/ 730	717199	51	1313	31,40/pc.
		2F/ 1000	717200	51	1313	36,07/pc.
	2F/ 1500	787276	51	1313	104,74/pc.	
	<b>Pendant double 20</b>					
	Acier galvanisé à chaud	20/ 505	715723	51	1313	65,51/pc.
		20/ 730	715724	51	1313	79,68/pc.
		20/ 1000	715725	51	1313	100,92/pc.
		20/ 1500	715726	51	1313	131,73/pc.
		20/ 2000	715727	51	1313	165,51/pc.
	20/ 3000	715728	51	1313	274,06/pc.	
	<b>Console 50i</b>					
	Acier galvanisé Sendzimir	50i/ 100	791412	52	1304	4,17/pc.
		50i/ 200	791413	52	1304	5,80/pc.
		50i/ 300	791414	52	1304	7,05/pc.
		50i/ 400	791415	52	1304	11,40/pc.
		50i/ 500	795322		1304	17,73/pc.
	50i/ 600	795323		1304	20,14/pc.	
	<b>Console 50i</b>					
	Acier galvanisé à chaud	50i/ 100	795316		1304	7,56/pc.
		50i/ 200	795317		1304	8,54/pc.
		50i/ 300	795318		1304	12,51/pc.
		50i/ 400	795319		1304	14,20/pc.
		50i/ 500	795320		1304	19,34/pc.
	50i/ 600	795321		1304	21,83/pc.	
	<b>Console murale ou plaque murale</b>					
	Acier galvanisé Sendzimir	70	80610	53	1127	11,18/pc.
	 20 pc. Deux ressorts 84901 à commander séparément.					
	<b>Profilé de suspension pour console</b>					
	Acier galvanisé Sendzimir	100	40611	53	1127	2,30/pc.
		120	80602	53	1127	2,60/pc.
		150	40616	53	1127	3,08/pc.
		200	80603	53	1127	4,21/pc.
		250	80604	53	1127	5,15/pc.
		300	40631	53	1127	6,65/pc.
		330	80605	53	1127	8,60/pc.
		400	80606	53	1127	10,90/pc.
		500	80607	53	1127	16,91/pc.
	Apte à ressort 84901.					
	<b>Ressort</b>					
	Acier inoxydable		84901		1127	1,72/pc.
	 25 pc. Deux pièces par profilé de suspension.					

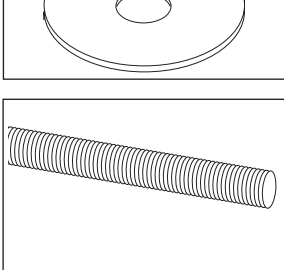
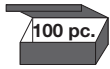
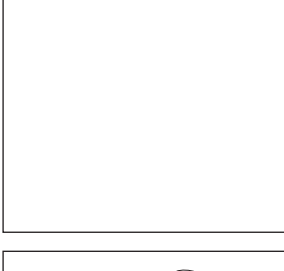
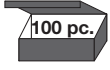
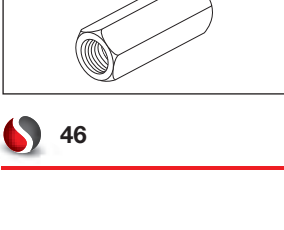
# Systemes de suspension – gaines et chemins de câbles

	type	référence	page catal.	groupe d'articles	prix en €
	<b>Etrier de serrage</b>				
	Acier galvanisé Sendzimir	M10	81501	53	1127
					
	<b>Etrier de serrage</b>				
	Acier galvanisé Sendzimir	M10	81503	52	1127
					
	<b>Etrier de plafond</b>				
	Acier galvanisé Sendzimir	M10	80200	52	1127
	<b>Etrier de plafond, ouvert</b>				
	Acier galvanisé à chaud	M10	80202	53	1127
	<b>Etrier de plafond, réglable</b>				
	Acier galvanisé à chaud	M10	80201	53	1127
	<b>Equerre W8</b>				
	Acier galvanisé Sendzimir	W8	716821	49	1306
					
	<b>Equerre W8</b>				
	Acier galvanisé à chaud	W8	728883	49	1306
					

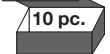

# Systemes de suspension – gaines et chemins de cables

	type	référence	page catal.	groupe d'articles	prix en €	
	<b>Vis crénelée</b>					
	Acier à zingage électrolytique	M6x10	08462000	57	1127	0,20/pc.
						
	<b>Vis crénelée</b>					
	Acier galvanisé à chaud	M6x10	08462020		1127	0,22/pc.
						
	<b>Ecrou 6 pans à embase crénelée</b>					
	Acier à zingage électrolytique	M6	08461000	57	1127	0,18/pc.
		M10	08890100		1127	0,53/pc.
	<b>Ecrou 6 pans à embase crénelée</b>					
	Acier galvanisé à chaud	M6	08461020		1127	0,23/pc.
						
	<b>Ecrou hexagonal</b>					
	Acier à zingage électrolytique	M6	08180000	57	1127	0,14/pc.
		M8	08891000	57	1127	0,16/pc.
		M10	08890000	57	1127	0,18/pc.
	<b>Rondelle</b>					
	Acier à zingage électrolytique	M6	08190000	57	1127	0,05/pc.
		M8	08901000	57	1127	0,08/pc.
		M10	08900000	57	1127	0,18/pc.
	<b>Rondelle</b>					
	Acier galvanisé à chaud	M6	08190020		1127	0,18/pc.
						
	<b>Rondelle carrosserie</b>					
	Acier à zingage électrolytique	M6	81977	57	1127	0,07/pc.
		M8	89077	57	1127	0,14/pc.
		M10	89177	57	1127	0,21/pc.
	<b>Tige filetée</b>					
	Acier à zingage électrolytique	M6	08050200	58	1127	2,54/m
		M8	08051000	58	1127	3,84/m
		M10	08050000	58	1127	4,57/m
	<b>Tige filetée</b>					
	Acier à zingage électrolytique	M10	08050100		1127	4,57/m
						
						
	<b>Tige filetée</b>					
	Acier galvanisé à chaud	M10	08051020		1127	15,10/m
						
						
	<b>Ecrou de rallonge hexagonal</b>					
	Acier à zingage électrolytique	M8x24	725083	58	1313	3,40/pc.
		M10x30	724806	58	1313	4,74/pc.

gaines à câbles  
fermées inducanal®

chemins de câbles  
perforés pemsaband®

# inducanal® gaines à câbles fermées

# pemsaband® chemins de câbles perforés

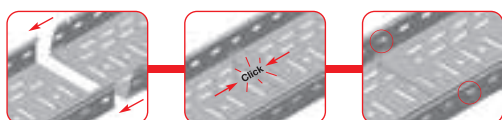

**Système click** – Le système de raccordement unique, pourvu de languettes, augmente la facilité de raccordement des longueurs et réduit considérablement la durée d'installation. Le système Click rend les plaques d'accouplement superflues lors du montage de tracés droits. Deux boulons à collet et écrous à embase crénelée suffisent pour fixer le raccordement.

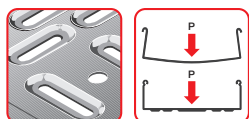

**Rigide** – Les chemins de câbles **pemsaband®** et gaines à câbles **inducanal®** en tôle d'acier sont pourvus d'une base profilée. Le relief dans la base augmente la résistance longitudinale et transversale. Les chemins de câbles et gaines à câbles en deviennent extrêmement solides avec une capacité élevée en comparaison d'un chemin de câbles sans relief, mais avec le même poids et la même épaisseur de plaque.



**Sûr** – Le rebord de sécurité vise à éviter que l'isolation des câbles ne s'abîme lors du tirage des câbles et que l'installateur ne se blesse. Le rebord offre en outre une rigidité supplémentaire.

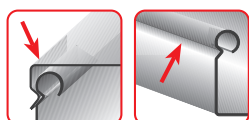

Les chemins de câbles **pemsaband®** et gaines à câbles **inducanal®** ont un rebord latéral bien fini, sur lequel s'encliquette parfaitement le couvercle Pemsaband approprié, qui ne nécessite aucun matériel de fixation supplémentaire. Même en cas d'installation verticale, le couvercle reste en place. Les couvercles des coins, des pièces en T, des rallonges, etc. sont également équipés d'un système Click.

**pemsa**band®**inducanal**®click **SX**click **LX****INOX**

click fermé

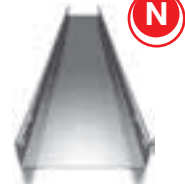
**INOX** fermé**Caractéristiques**

<b>G.S.</b>	✓	✓		✓	
<b>H.D.</b>	✓	✓		✓	
<b>INOX 304</b>			✓		✓
mm	100-600	100-600	100-600	60-600	60-600
mm	60/85 (click) 100 (non-click)	35/60/85 (click) 100 (non-click)	60	35/60/85 (click) 100 (non-click)	60
<b>L</b> mm	3000	3000	3000	3000	3000
	-50 °C / +150 °C				
N/m					
	20 J.				
	E60				

**Applications**

Tertiaire	✓	✓		✓	
Tunnels	✓	✓		✓	
Centres de données	✓	✓		✓	
Installations PV	✓	✓			
Industrie alimentaire	✓	✓	✓	✓	✓
Pétrochimie	✓	✓	✓	✓	✓
<b>G.S.</b>	page 49	page 49	-	page 50	-
<b>H.D.</b>	page 57	page 57	-	page 58	-
<b>INOX 304</b>	-	-	page 65	-	page 65



**G.S.** galvanisation Sendzimir NBN EN 10346 – recommandé dans les environnements corrosifs C2 (faible)  
**H.D.** galvanisation à chaud NBN EN ISO 1461 – recommandé dans les environnements corrosifs C3/C4 (moyen/haut)  
**INOX 304** acier inoxydable AISI 304 – recommandé dans les environnements corrosifs C5-I (très haut – industrie)

voir page 2







### Chemin de câbles Pemsaband LX Click, H = 35 mm

Acier galvanisé Sendzimir

type	référence	page catal.	groupe d'articles	prix en €	
 	35x100	75821100	8	2308	7,81/m
	35x150	75821150	8	2308	9,70/m
	35x200	75821200	8	2308	12,83/m
	35x300	75821300	8	2308	17,00/m





### Chemin de câbles Pemsaband LX Click, H = 60 mm

Acier galvanisé Sendzimir

 	60x100	75822100		2310	8,22/m
	60x150	75822150		2310	10,84/m
	60x200	75822200		2310	12,26/m
	60x300	75822300		2310	15,97/m
	60x400	75822400		2310	19,97/m
	60x500	75822500		2310	28,01/m
	60x600	75822600		2310	32,80/m

### Chemin de câbles Pemsaband SX Click, H = 60 mm

Acier galvanisé Sendzimir

 	60x100	75522100	8	2308	9,53/m
	60x150	75522150	8	2308	12,73/m
	60x200	75522200	8	2308	13,80/m
	60x300	75522300	8	2308	18,37/m
	60x400	75522400	8	2308	26,53/m
	60x500	75522500	8	2308	31,15/m
	60x600	75522600	8	2308	36,57/m

### Chemin de câbles Pemsaband LX Click, H = 85 mm

Acier galvanisé Sendzimir

	85x200	75223200	8	2308	sur demande
	85x300	75223300	8	2308	sur demande
	85x400	75223400	8	2308	sur demande
	85x500	75223500	8	2308	sur demande
	85x600	75223600	8	2308	sur demande

### Chemin de câbles Pemsaband LX, H = 100 mm

Acier galvanisé Sendzimir

	100x200	75224200	8	2308	sur demande
	100x300	75224300	8	2308	sur demande
	100x400	75224400	8	2308	sur demande
	100x500	75224500	8	2308	sur demande
	100x600	75224600	8	2308	sur demande

### Accouplement Reijband-Pemsaband

Acier galvanisé Sendzimir



60	70120200	20	2309	20,08/set
----	----------	----	------	-----------









### Gaine à câbles Inducanal Click, H= 35 mm

Acier galvanisé Sendzimir

type	référence	page catal.	groupe d'articles	prix en €	
 	35x100	75121100	8	2311	7,81/m
	35x150	75121150	8	2311	9,70/m
	35x200	75121200	8	2311	12,83/m
	35x300	75121300	8	2311	17,00/m

### Gaine à câbles Inducanal Click, H= 60 mm

Acier galvanisé Sendzimir

 	60x060	75122060	8	2311	9,53/m
	60x100	75122100	8	2311	9,53/m
	60x150	75122150	8	2311	12,73/m
	60x200	75122200	8	2311	13,80/m
	60x300	75122300	8	2311	18,37/m
	60x400	75122400	8	2311	26,53/m
	60x500	75122500	8	2311	31,15/m
	60x600	75122600	8	2311	49,46/m

### Gaine à câbles Inducanal Click, H= 85 mm

Acier galvanisé Sendzimir

	85x200	75423200	8	2311	sur demande
	85x300	75423300	8	2311	sur demande
	85x400	75423400	8	2311	sur demande
	85x500	75423500	8	2311	sur demande
	85x600	75423600	8	2311	sur demande

### Gaine à câbles Inducanal, H = 100 mm

Acier galvanisé Sendzimir

	100x200	75424200	8	2311	sur demande
	100x300	75424300	8	2311	sur demande
	100x400	75424400	8	2311	sur demande
	100x500	75424500	8	2311	sur demande
	100x600	75424600	8	2311	sur demande

### Boulon à collet carré et écrou 6 pans à embase crénelée

Acier à zingage électrolytique

M6X12 67010093 2309 0,33/pc.



### Boulon à collet carré

Acier à zingage électrolytique

M6x12 67010099 2309 0,24/pc.

M6x20 67010100 9 2309 0,24/pc.

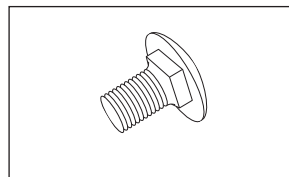

### Écrou 6 pans à embase crénelée





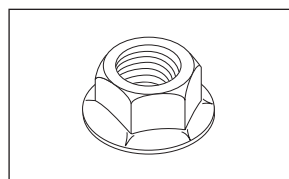





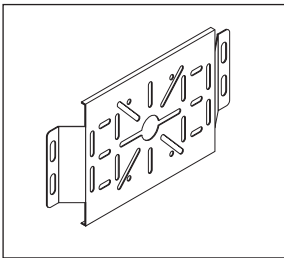
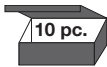

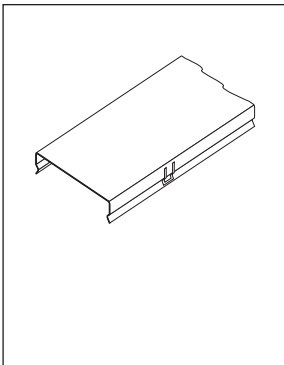

Acier à zingage électrolytique

M6 64010059 9 2309 0,18/pc.

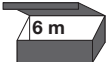
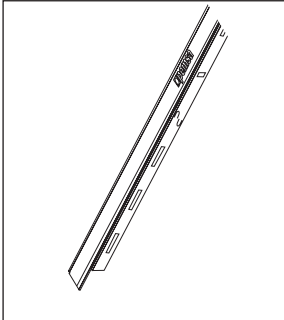

	type	référence	page catal.	groupe d'articles	prix en €	
	<b>Accouplement</b>					
	Acier galvanisé Sendzimir	35	71021005	9	2309	1,37/pc.
	<b>Accouplement</b>					
	Acier galvanisé Sendzimir	60	93910002		2309	2,00/pc.
	<b>Accouplement</b>					
	Acier galvanisé Sendzimir	85/100	93910003		2309	sur demande
	<b>Plaque pour pièce de montée/descente</b>					
	Acier galvanisé Sendzimir	35	71021006	10	2309	1,14/pc.
		4 pc.				
	4 plaques pour 1 pièce de montée/descente.					
	<b>Plaque pour pièce de montée/descente</b>					
	Acier galvanisé Sendzimir	60	93910012		2309	2,11/pc.
		8 pc.				
	4 plaques pour 1 pièce de montée/descente.					
	<b>Plaque pour pièce de montée/descente</b>					
	Acier galvanisé Sendzimir	85/100	93910013	10	2309	sur demande
		8 pc.				
	4 plaques pour 1 pièce de montée/descente.					
	<b>Accouplement de fond</b>					
	Acier galvanisé Sendzimir	300	71020300	9	2309	7,71/pc.
		400	71020400	9	2309	8,95/pc.
		500	71020500	9	2309	10,04/pc.
		600	71020600	9	2309	12,10/pc.
		10 pc.				

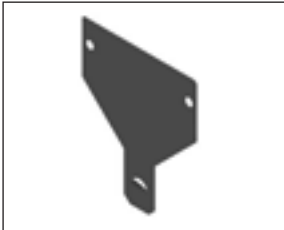

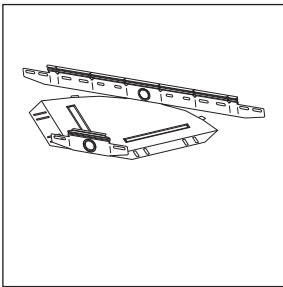
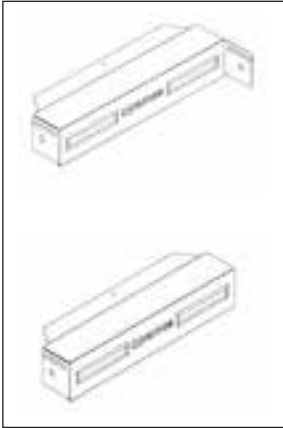
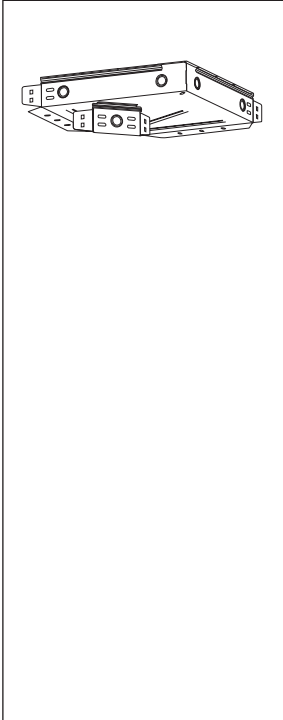
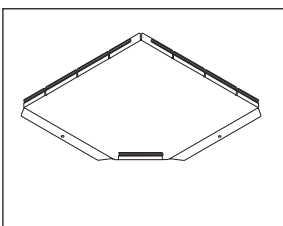

	type	référence	page catal.	groupe d'articles	prix en €	
	<b>Plaque de montage Pemsaband</b>					
	Acier galvanisé Sendzimir	60	70420911	15	2309	5,76/pc.
						
	<b>Bande de protection</b>					
	Caoutchouc/adhésif		71000000	15	2309	6,56/m
						
	<b>Borne de terre</b>					
	Cuivre	16-50 mm <sup>2</sup>	68000034	15	2309	5,58/pc.
						
	<b>Couvercle Click</b>					
	Acier galvanisé Sendzimir					
		60	73021060	8	2316	6,64/m
		100	73021100	8	2316	8,57/m
						
		150	73021150	8	2316	11,11/m
						
		200	73021200	8	2316	13,52/m
						
		300	73021300	8	2316	20,63/m
	400	73021400	8	2316	26,43/m	
	500	73021500	8	2316	35,79/m	
	600	73021600	8	2316	42,01/m	
	<b>Cloison de séparation</b>					
	Acier galvanisé Sendzimir					
		25	67020610	10	2316	6,61/m
						
		50	67020611	10	2316	7,43/m
	80	67020612	10	2316	13,07/m	
						
	<b>Plaque d'identification</b>					
	Matière synthétique		68000020	10	2307	1,10/pc.
						

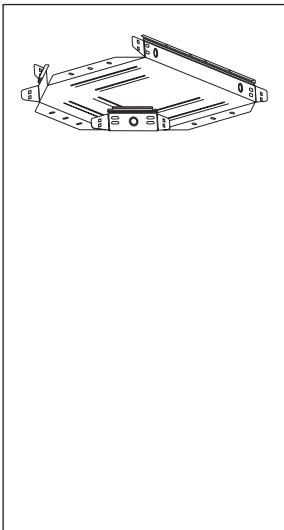
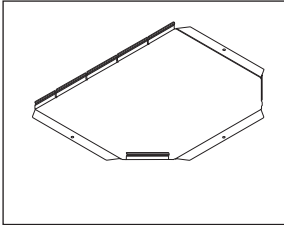
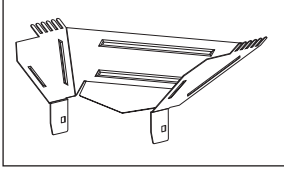
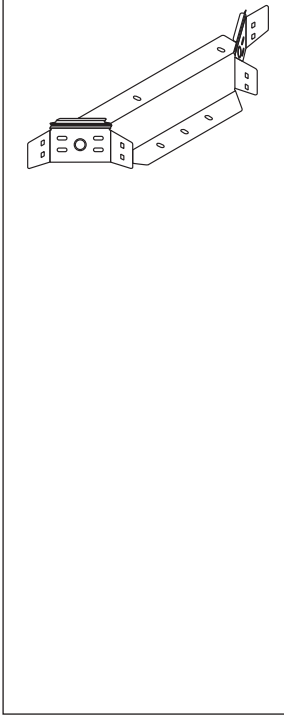
	type	référence	page catal.	groupe d'articles	prix en €	
	<b>Courbe réglable</b>					
	Acier galvanisé Sendzimir	35x100	70028110	14	2309	34,00/pc.
		35x150	70028115	14	2309	35,84/pc.
	Livrée sous forme aplanie.	35x200	70028120	14	2309	41,76/pc.
		35x300	70028130	14	2309	46,84/pc.
		60x100	70028210	14	2309	34,52/pc.
		60x150	70028215	14	2309	36,63/pc.
		60x200	70028220	14	2309	42,45/pc.
	60x300	70028230	14	2309	47,87/pc.	
	<b>Embout et réduction</b>					
	Acier galvanisé Sendzimir	35x100	71021010	14	2309	21,57/pc.
		35x150	71021015	14	2309	27,85/pc.
	Livrée sous forme aplanie.	35x200	71021020	14	2309	29,61/pc.
		35x300	71021030	14	2309	39,99/pc.
		60x100	71022010	14	2309	22,93/pc.
		60x150	71022015	14	2309	30,00/pc.
		60x200	71022020	14	2309	33,84/pc.
		60x300	71022030	14	2309	44,16/pc.
		<b>Courbe Click 90°</b>				
Acier galvanisé Sendzimir		35x100	70020110	11	2309	23,96/pc.
		35x150	70020115	11	2309	26,76/pc.
Livrée sous forme aplanie.		35x200	70020120	11	2309	30,64/pc.
		35x300	70020130	11	2309	35,55/pc.
		60x060	70020206	11	2309	22,87/pc.
		60x100	70020210	11	2309	22,87/pc.
		60x150	70020215	11	2309	24,54/pc.
		60x200	70020220	11	2309	26,34/pc.
		60x300	70020230	11	2309	38,98/pc.
		60x400	70020240	11	2309	50,36/pc.
		60x500	70020250	11	2309	58,05/pc.
		60x600	70020260	11	2309	76,06/pc.
		85x200	70020320	11	2309	sur demande
		85x300	70020330	11	2309	sur demande
		85x400	70020340	11	2309	sur demande
		85x500	70020350	11	2309	sur demande
		85x600	70020360	11	2309	sur demande
	100x200	70020420	11	2309	sur demande	
	100x300	70020430	11	2309	sur demande	
	100x400	70020440	11	2309	sur demande	
	100x500	70020450	11	2309	sur demande	
	100x600	70020460	11	2309	sur demande	
	<b>Couvercle pour courbe Click 90°</b>					
	Acier galvanisé Sendzimir	60	73020060	11	2309	19,97/pc.
		100	73020100	11	2309	19,97/pc.
		150	73020150	11	2309	22,82/pc.
		200	73020200	11	2309	25,56/pc.
		300	73020300	11	2309	34,00/pc.
		400	73020400	11	2309	62,70/pc.
		500	73020500	11	2309	78,97/pc.
600		73020600	11	2309	90,20/pc.	

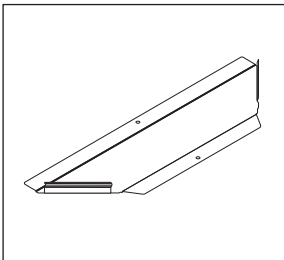
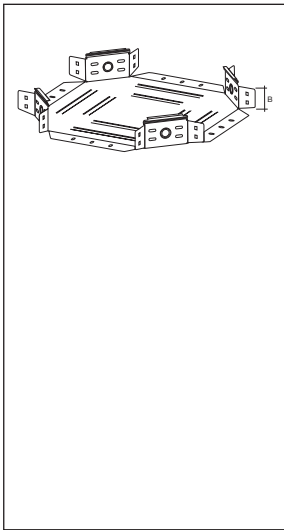
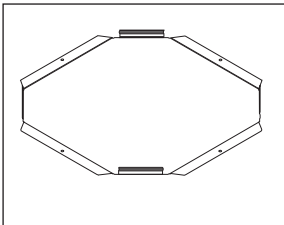
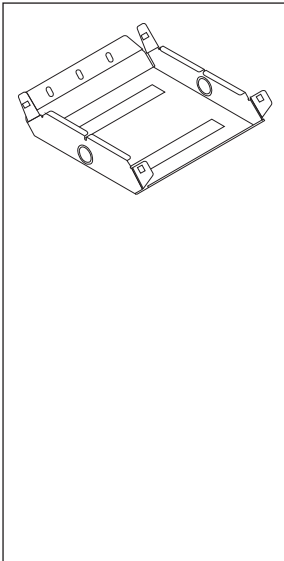
	type	référence	page catal.	groupe d'articles	prix en €	
	<b>Pièce en T Click</b>					
	Acier galvanisé Sendzimir	35x100	70022110	11	2309	31,72/pc.
		35x150	70022115	11	2309	35,43/pc.
	Livrée sous forme aplanie.	35x200	70022120	11	2309	40,62/pc.
		35x300	70022130	11	2309	47,07/pc.
		60x100	70022210	11	2309	33,04/pc.
		60x150	70022215	11	2309	37,03/pc.
		60x200	70022220	11	2309	42,33/pc.
		60x300	70022230	11	2309	48,89/pc.
		60x400	70022240	11	2309	91,05/pc.
		60x500	70022250	11	2309	130,71/pc.
		60x600	70022260	11	2309	149,38/pc.
		85x200	70022320	11	2309	sur demande
		85x300	70022330	11	2309	sur demande
		85x400	70022340	11	2309	sur demande
	85x500	70022350	11	2309	sur demande	
	85x600	70022360	11	2309	sur demande	
	<b>Couvercle pour pièce en T Click</b>					
	Acier galvanisé Sendzimir	100	73022100	11	2309	26,48/pc.
		150	73022150	11	2309	29,61/pc.
		200	73022200	11	2309	33,84/pc.
		300	73022300	11	2309	48,55/pc.
		400	73022400	11	2309	72,00/pc.
		500	73022500	11	2309	103,45/pc.
600		73022600	11	2309	118,15/pc.	
	<b>Pièce murale verticale</b>					
	Acier galvanisé Sendzimir	60x100	70027100	20	2309	13,87/pc.
		60x150	70027150	20	2309	15,75/pc.
	Livrée sous forme aplanie.					
	<b>Dérivation Click</b>					
	Acier galvanisé Sendzimir	35x100	70023110	12	2309	23,78/pc.
		35x150	70023115	12	2309	26,48/pc.
	Livrée sous forme aplanie.	35x200	70023120	12	2309	30,87/pc.
		35x300	70023130	12	2309	35,19/pc.
		60x060	70023206	12	2309	19,61/pc.
		60x100	70023210	12	2309	19,61/pc.
		60x150	70023215	12	2309	20,49/pc.
		60x200	70023220	12	2309	22,21/pc.
		60x300	70023230	12	2309	34,46/pc.
		60x400	70023240	12	2309	49,60/pc.
		60x500	70023250	12	2309	56,79/pc.
		60x600	70023260	12	2309	60,00/pc.
		85x200	70023320	12	2309	sur demande
		85x300	70023330	12	2309	sur demande
		85x400	70023340	12	2309	sur demande
		85x500	70023350	12	2309	sur demande
		85x600	70023360	12	2309	sur demande
		100x200	70023420	12	2309	sur demande
		100x300	70023430	12	2309	sur demande
	100x400	70023440	12	2309	sur demande	
	100x500	70023450	12	2309	sur demande	
	100x600	70023460	12	2309	sur demande	

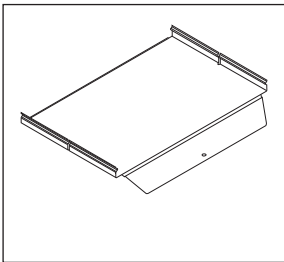
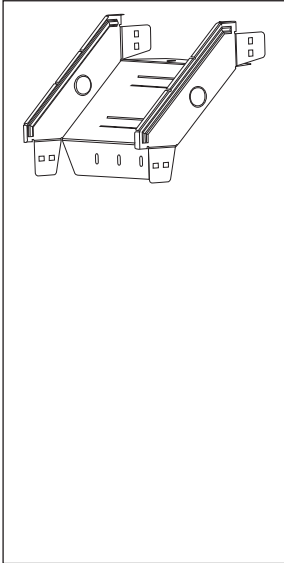
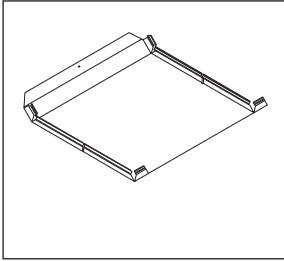

	type	référence	page catal.	groupe d'articles	prix en €	
	<b>Couvercle pour dérivation Click</b>					
	Acier galvanisé Sendzimir	60	73023060	12	2309	20,20/pc.
		100	73023100	12	2309	20,20/pc.
		150	73023150	12	2309	20,49/pc.
		200	73023200	12	2309	21,51/pc.
		300	73023300	12	2309	27,78/pc.
		400	73023400	12	2309	28,98/pc.
		500	73023500	12	2309	35,27/pc.
	600	73023600	12	2309	36,51/pc.	
	<b>Croisillon Click</b>					
	Acier galvanisé Sendzimir	35x100	70024110	12	2309	34,69/pc.
		35x150	70024115	12	2309	37,43/pc.
	Livrée sous forme aplanie.	35x200	70024120	12	2309	43,36/pc.
		35x300	70024130	12	2309	51,41/pc.
		60x100	70024210	12	2309	35,60/pc.
		60x150	70024215	12	2309	36,06/pc.
		60x200	70024220	12	2309	41,76/pc.
		60x300	70024230	12	2309	50,95/pc.
		60x400	70024240	12	2309	57,97/pc.
		60x500	70024250	12	2309	108,30/pc.
		60x600	70024260	12	2309	149,25/pc.
		85x200	70024320	12	2309	sur demande
		85x300	70024330	12	2309	sur demande
	85x400	70024340	12	2309	sur demande	
	85x500	70024350	12	2309	sur demande	
	85x600	70024360	12	2309	sur demande	
	<b>Couvercle pour croisillon Click</b>					
	Acier galvanisé Sendzimir	100	73024100	12	2309	29,95/pc.
		150	73024150	12	2309	32,70/pc.
		200	73024200	12	2309	36,97/pc.
		300	73024300	12	2309	51,58/pc.
		400	73024400	12	2309	79,54/pc.
		500	73024500	12	2309	112,96/pc.
		600	73024600	12	2309	129,12/pc.
	<b>Pièce de montée Click</b>					
	Acier galvanisé Sendzimir	35x100	70025110	13	2309	29,44/pc.
		35x150	70025115	13	2309	32,86/pc.
	Livrée sous forme aplanie.	35x200	70025120	13	2309	37,66/pc.
		35x300	70025130	13	2309	43,65/pc.
		60x060	70025206	13	2309	22,21/pc.
		60x100	70025210	13	2309	22,21/pc.
		60x150	70025215	13	2309	26,57/pc.
		60x200	70025220	13	2309	29,24/pc.
		60x300	70025230	13	2309	44,02/pc.
		60x400	70025240	13	2309	58,27/pc.
		60x500	70025250	13	2309	64,17/pc.
		60x600	70025260	13	2309	84,13/pc.
		85x200	70025320	13	2309	sur demande
	85x300	70025330	13	2309	sur demande	
	85x400	70025340	13	2309	sur demande	
	85x500	70025350	13	2309	sur demande	
	85x600	70025360	13	2309	sur demande	

	type	référence	page catal.	groupe d'articles	prix en €		
	<b>Couvercle pour pièce de montée Click</b>						
	Acier galvanisé Sendzimir	60	73025060	13	2309	24,53/pc.	
		100	73025100	13	2309	24,53/pc.	
		150	73025150	13	2309	27,45/pc.	
		200	73025200	13	2309	31,38/pc.	
		300	73025300	13	2309	43,88/pc.	
		400	73025400	13	2309	67,50/pc.	
		500	73025500	13	2309	96,94/pc.	
600		73025600	13	2309	110,74/pc.		
	<b>Pièce de descente Click</b>						
	Acier galvanisé Sendzimir	35x100	70026110	13	2309	29,44/pc.	
		35x150	70026115	13	2309	32,86/pc.	
		Livrée sous forme aplanie.	35x200	70026120	13	2309	37,66/pc.
			35x300	70026130	13	2309	43,65/pc.
		60x060	70026206	13	2309	22,21/pc.	
		60x100	70026210	13	2309	22,21/pc.	
		60x150	70026215	13	2309	26,57/pc.	
		60x200	70026220	13	2309	29,24/pc.	
		60x300	70026230	13	2309	44,02/pc.	
		60x400	70026240	13	2309	58,27/pc.	
		60x500	70026250	13	2309	64,17/pc.	
		60x600	70026260	13	2309	84,13/pc.	
		85x200	70026320	13	2309	sur demande	
		85x300	70026330	13	2309	sur demande	
85x400		70026340	13	2309	sur demande		
85x500	70026350	13	2309	sur demande			
85x600	70026360	13	2309	sur demande			
	<b>Couvercle pour pièce de descente Click</b>						
	Acier galvanisé Sendzimir	60	73026060	13	2309	23,73/pc.	
		100	73026100	13	2309	23,73/pc.	
		150	73026150	13	2309	26,58/pc.	
		200	73026200	13	2309	30,35/pc.	
		300	73026300	13	2309	42,50/pc.	
		400	73026400	13	2309	65,38/pc.	
		500	73026500	13	2309	93,85/pc.	
600		73026600	13	2309	107,27/pc.		
	<b>Dérivation universelle Click</b>						
	Acier galvanisé Sendzimir	35	70021100	14	2309	12,95/pc.	
		60	70021200	14	2309	13,52/pc.	
		Livrée sous forme aplanie.	85	70021300	14	2309	sur demande
			100	70021400	14	2309	sur demande





### Chemin de câbles Pemsaband LX Click, H = 35 mm

Acier galvanisé à chaud

type	référence	page catal.	groupe d'articles	prix en €
 	35x100 75831100	8	2308	19,92/m
	35x150 75831150	8	2308	24,81/m
	35x200 75831200	8	2308	30,92/m
	35x300 75831300	8	2308	41,42/m



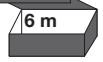

### Chemin de câbles Pemsaband LX Click, H = 60 mm

Acier galvanisé à chaud

 	60x100 75832100		2310	21,06/m
	60x150 75832150		2310	26,30/m
	60x200 75832200		2310	30,30/m
	60x300 75832300		2310	40,51/m
	60x400 75832400		2310	51,64/m
	60x500 75832500		2310	63,27/m
	60x600 75832600		2310	72,75/m



### Chemin de câbles Pemsaband SX Click, H = 60 mm

Acier galvanisé à chaud

 	60x100 75232100	8	2308	24,88/m
	60x150 75232150	8	2308	29,38/m
	60x200 75232200	8	2308	35,32/m
	60x300 75232300	8	2308	44,96/m
	60x400 75232400	8	2308	58,08/m
	60x500 75232500	8	2308	76,74/m
	60x600 75232600	8	2308	91,11/m



### Chemin de câbles Pemsaband LX Click, H = 85 mm

Acier galvanisé à chaud

 	85x200 75233200	8	2308	sur demande
	85x300 75233300	8	2308	sur demande
	85x400 75233400	8	2308	sur demande
	85x500 75233500	8	2308	sur demande
	85x600 75233600	8	2308	sur demande

### Chemin de câbles Pemsaband LX, H = 100 mm

Acier galvanisé à chaud

 	100x200 75234200	8	2308	sur demande
	100x300 75234300	8	2308	sur demande
	100x400 75234400	8	2308	sur demande
	100x500 75234500	8	2308	sur demande
	100x600 75234600	8	2308	sur demande

### Accouplement Reijband-Pemsaband

Acier galvanisé à chaud



	60 70130200	20	2309	24,14/set
---	-------------	----	------	-----------







### Gainie à câbles Inducanal Click, H= 35 mm

Acier galvanisé à chaud

type	référence	page catal.	groupe d'articles	prix en €	
 	35x100	75131100	8	2311	22,19/m
	35x150	75131150	8	2311	25,45/m
	35x200	75131200	8	2311	30,87/m
	35x300	75131300	8	2311	40,56/m

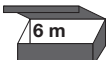

### Gainie à câbles Inducanal Click, H= 60 mm

Acier galvanisé à chaud

 	60x060	75132060	8	2311	24,99/m
	60x100	75132100	8	2311	24,99/m
	60x150	75132150	8	2311	32,47/m
	60x200	75132200	8	2311	34,47/m
	60x300	75132300	8	2311	44,11/m
	60x400	75132400	8	2311	82,84/m
	60x500	75132500	8	2311	93,39/m
	60x600	75132600	8	2311	107,20/m

### Gainie à câbles Inducanal Click, H= 85 mm

Acier galvanisé à chaud

 	85x200	75433200	8	2311	sur demande
	85x300	75433300	8	2311	sur demande
	85x400	75433400	8	2311	sur demande
	85x500	75433500	8	2311	sur demande
	85x600	75433600	8	2311	sur demande

### Gainie à câbles Inducanal, H = 100 mm

Acier galvanisé à chaud

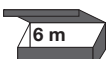
 	100x200	75434200	8	2311	sur demande
	100x300	75434300	8	2311	sur demande
	100x400	75434400	8	2311	sur demande
	100x500	75434500	8	2311	sur demande
	100x600	75434600	8	2311	sur demande

### Boulon à collet carré et écrou 6 pans à embase crénelée

Acier galvanisé à chaud

M6x12	67030093	2309	0,46/pc.
			

### Boulon à collet carré

Acier galvanisé à chaud







M6x12	67030099	2309	0,28/pc.	
M6x20	67030100	9	2309	0,41/pc.
				



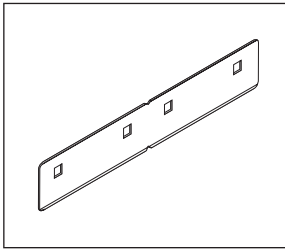

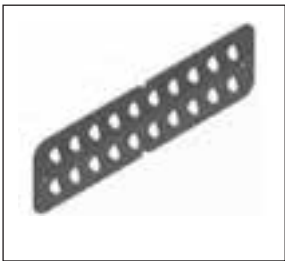
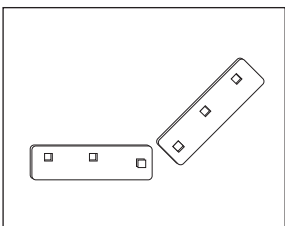
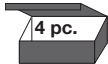
### Écrou 6 pans à embase crénelée

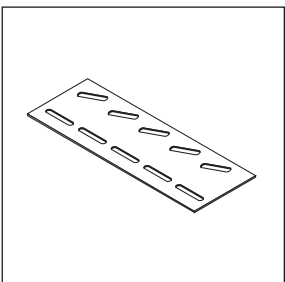
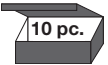

Acier galvanisé à chaud

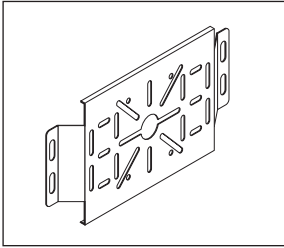
M6	64030059	9	2309	0,23/pc.
				

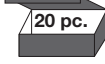
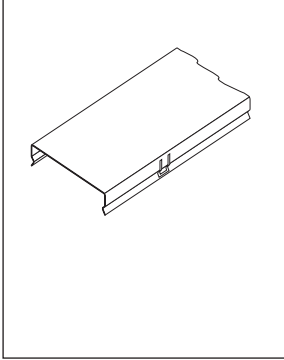
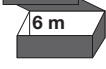
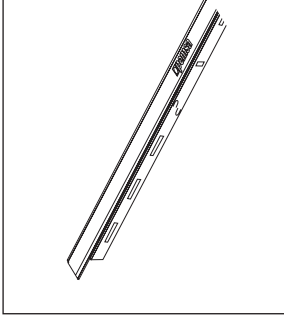

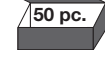

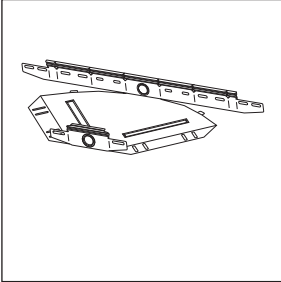
	type	référence	page catal.	groupe d'articles	prix en €	
	<b>Accouplement</b>					
	Acier galvanisé à chaud	35	71031005	9	2309	1,82/pc.
	<b>Accouplement</b>					
	Acier galvanisé à chaud	60	93930002		2309	2,91/pc.
	<b>Accouplement</b>					
	Acier galvanisé à chaud	85/100	93930003		2309	sur demande
	<b>Plaque pour pièce de montée/descente</b>					
	Acier galvanisé à chaud	35	71031006	9	2309	1,60/pc.
						
					4 plaques pour 1 pièce de montée/descente.	
	<b>Plaque pour pièce de montée/descente</b>					
	Acier galvanisé à chaud	60	93930012		2309	2,52/pc.
						
					4 plaques pour 1 pièce de montée/descente.	
	<b>Plaque pour pièce de montée/descente</b>					
	Acier galvanisé à chaud	85/100	93930013	10	2309	sur demande
						
					4 plaques pour 1 pièce de montée/descente.	
	<b>Accouplement de fond</b>					
	Acier galvanisé à chaud	300	71030300	9	2309	10,84/pc.
		400	71030400	9	2309	12,55/pc.
		500	71030500	9	2309	17,12/pc.
		600	71030600	9	2309	20,54/pc.
						

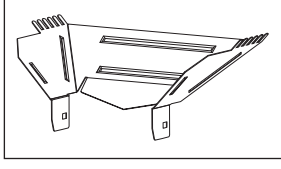
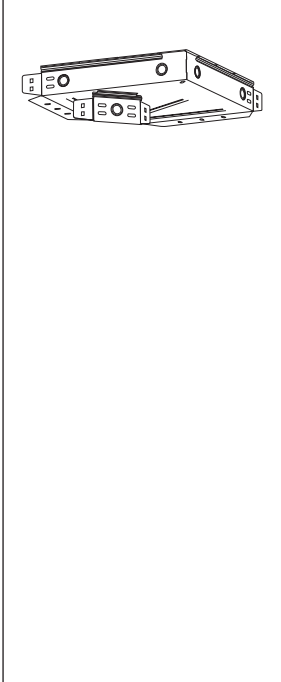
	type	référence	page catal.	groupe d'articles	prix en €		
	<b>Plaque de montage Pemsaband</b>						
	Acier galvanisé à chaud	60	70430911	15	2309	8,74/pc.	
							
	<b>Bande de protection</b>						
	Caoutchouc/adhésif		71000000	15	2309	6,56/m	
							
	<b>Borne de terre</b>						
	Cuivre	16-50 mm <sup>2</sup>	68000034	15	2309	5,58/pc.	
							
	<b>Couvercle Click</b>						
	Acier galvanisé à chaud						
			60	73031060	8	2316	11,13/m
			100	73031100	8	2316	15,52/m
			150	73031150	8	2316	21,11/m
			200	73031200	8	2316	26,71/m
			300	73031300	8	2316	40,62/m
			400	73031400	8	2316	52,60/m
			500	73031500	8	2316	64,58/m
			600	73031600	8	2316	76,56/m
	<b>Cloison de séparation</b>						
	Acier galvanisé à chaud						
			25	67030610	10	2316	9,07/m
			50	67030611	10	2316	12,32/m
		80	67030612	10	2316	17,35/m	
	<b>Plaque d'identification</b>						
	Matière synthétique		68000020	10	2307	1,10/pc.	
							

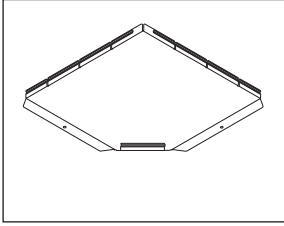
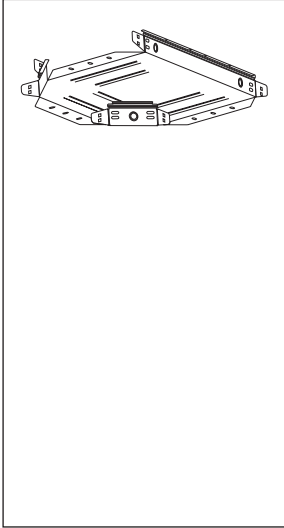
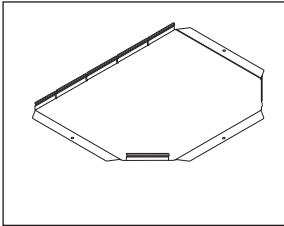
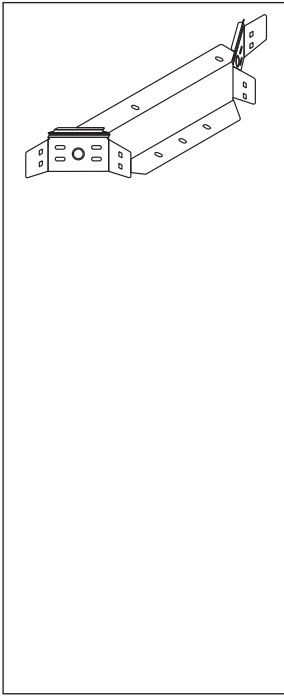
	type	référence	page catal.	groupe d'articles	prix en €	
	<b>Courbe réglable</b>					
	Acier galvanisé à chaud	35x100	70038110	14	2309	38,23/pc.
		35x150	70038115	14	2309	40,90/pc.
		35x200	70038120	14	2309	48,67/pc.
		35x300	70038130	14	2309	56,77/pc.
		60x100	70038210	14	2309	39,36/pc.
		60x150	70038215	14	2309	42,62/pc.
		60x200	70038220	14	2309	50,49/pc.
60x300		70038230	14	2309	59,51/pc.	
	<b>Embout</b>					
	Acier galvanisé à chaud	35x100	70039110	14	2309	22,42/pc.
		35x150	70039115	14	2309	29,28/pc.
		35x200	70039120	14	2309	34,17/pc.
		35x300	70039130	14	2309	45,53/pc.
		60x100	70039210	14	2309	24,19/pc.
		60x150	70039215	14	2309	30,92/pc.
		60x200	70039220	14	2309	37,43/pc.
60x300		70039230	14	2309	51,69/pc.	
	<b>Réduction</b>					
	Acier galvanisé à chaud	35x100	71031010	14	2309	22,82/pc.
		35x150	71031015	14	2309	29,72/pc.
		35x200	71031020	14	2309	34,69/pc.
		35x300	71031030	14	2309	46,22/pc.
		60x100	71032010	14	2309	24,53/pc.
		60x150	71032015	14	2309	31,38/pc.
		60x200	71032020	14	2309	37,99/pc.
60x300		71032030	14	2309	49,52/pc.	
	<b>Pièce murale verticale</b>					
	Acier galvanisé à chaud	60x100	70037100	20	2309	35,09/pc.
		60x150	70037150	20	2309	39,54/pc.
	<b>Courbe Click 90°</b>					
	Acier galvanisé à chaud	35x100	70030110	11	2309	27,50/pc.
		35x150	70030115	11	2309	30,64/pc.
		35x200	70030120	11	2309	35,19/pc.
		35x300	70030130	11	2309	46,61/pc.
		60x100	70030210	11	2309	29,56/pc.
		60x150	70030215	11	2309	32,06/pc.
		60x200	70030220	11	2309	36,69/pc.
		60x300	70030230	11	2309	49,87/pc.
		60x400	70030240	11	2309	85,47/pc.
		60x500	70030250	11	2309	130,71/pc.
		60x600	70030260	11	2309	157,76/pc.
		85x200	70030320	11	2309	sur demande
		85x300	70030330	11	2309	sur demande
		85x400	70030340	11	2309	sur demande
		85x500	70030350	11	2309	sur demande
		85x600	70030360	11	2309	sur demande
		100x200	70030420	11	2309	sur demande
		100x300	70030430	11	2309	sur demande
		100x400	70030440	11	2309	sur demande
100x500		70030450	11	2309	sur demande	
100x600	70030460	11	2309	sur demande		

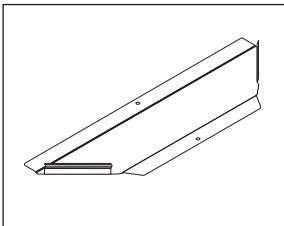
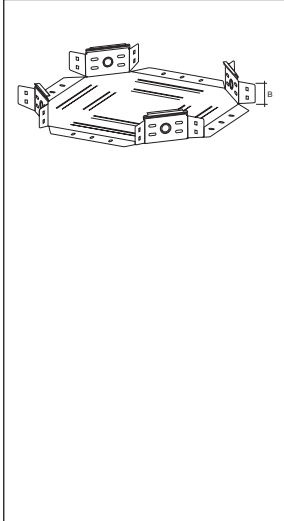
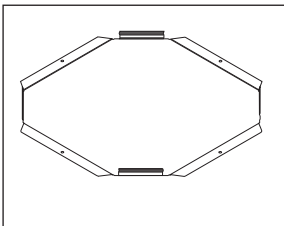
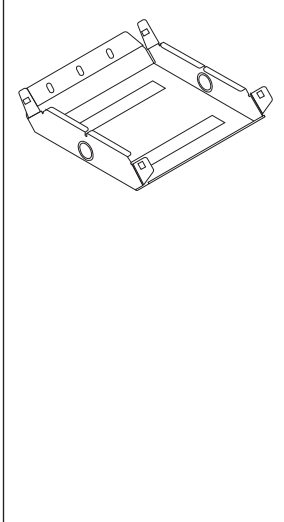
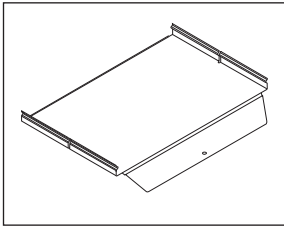

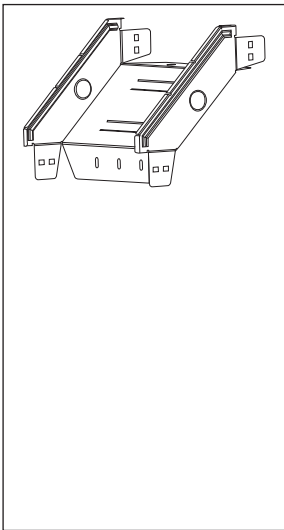
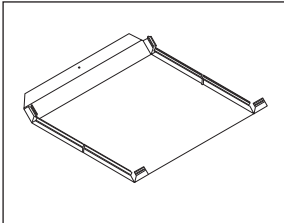

	type	référence	page catal.	groupe d'articles	prix en €	
	<b>Couvercle pour courbe Click 90°</b>					
	Acier galvanisé à chaud	100	73030100	11	2309	24,01/pc.
		150	73030150	11	2309	26,93/pc.
		200	73030200	11	2309	30,07/pc.
		300	73030300	11	2309	42,96/pc.
		400	73030400	11	2309	72,12/pc.
		500	73030500	11	2309	92,82/pc.
	600	73030600	11	2309	108,46/pc.	
	<b>Pièce en T Click</b>					
	Acier galvanisé à chaud	35x100	70032110	11	2309	38,28/pc.
		35x150	70032115	11	2309	42,73/pc.
		35x200	70032120	11	2309	50,10/pc.
		35x300	70032130	11	2309	56,14/pc.
		60x100	70032210	11	2309	40,79/pc.
		60x150	70032215	11	2309	44,68/pc.
		60x200	70032220	11	2309	51,06/pc.
		60x300	70032230	11	2309	65,89/pc.
		60x400	70032240	11	2309	112,34/pc.
		60x500	70032250	11	2309	155,94/pc.
		60x600	70032260	11	2309	187,48/pc.
		85x200	70032320	11	2309	sur demande
		85x300	70032330	11	2309	sur demande
		85x400	70032340	11	2309	sur demande
	85x500	70032350	11	2309	sur demande	
	85x600	70032360	11	2309	sur demande	
	<b>Couvercle pour pièce en T Click</b>					
	Acier galvanisé à chaud	100	73032100	11	2309	48,04/pc.
		150	73032150	11	2309	52,31/pc.
		200	73032200	11	2309	58,87/pc.
		300	73032300	11	2309	80,05/pc.
		400	73032400	11	2309	125,86/pc.
		500	73032500	11	2309	180,97/pc.
	600	73032600	11	2309	185,19/pc.	
	<b>Dérivation Click</b>					
	Acier galvanisé à chaud	35x100	70033110	12	2309	29,44/pc.
		35x150	70033115	12	2309	32,86/pc.
		35x200	70033120	12	2309	38,56/pc.
		35x300	70033130	12	2309	44,68/pc.
		60x100	70033210	12	2309	31,38/pc.
		60x150	70033215	12	2309	35,14/pc.
		60x200	70033220	12	2309	40,16/pc.
		60x300	70033230	12	2309	46,39/pc.
		60x400	70033240	12	2309	54,60/pc.
		60x500	70033250	12	2309	59,68/pc.
		60x600	70033260	12	2309	65,16/pc.
		85x200	70033320	12	2309	sur demande
		85x300	70033330	12	2309	sur demande
		85x400	70033340	12	2309	sur demande
		85x500	70033350	12	2309	sur demande
		85x600	70033360	12	2309	sur demande
		100x200	70033420	12	2309	sur demande
	100x300	70033430	12	2309	sur demande	
	100x400	70033440	12	2309	sur demande	
	100x500	70033450	12	2309	sur demande	
	100x600	70033460	12	2309	sur demande	

	type	référence	page catal.	groupe d'articles	prix en €	
	<b>Couvercle pour dérivation Click</b>					
	Acier galvanisé à chaud	100	73033100	12	2309	23,57/pc.
		150	73033150	12	2309	24,93/pc.
		200	73033200	12	2309	26,25/pc.
		300	73033300	12	2309	33,55/pc.
		400	73033400	12	2309	35,27/pc.
		500	73033500	12	2309	42,68/pc.
	600	73033600	12	2309	44,73/pc.	
	<b>Croisillon Click</b>					
	Acier galvanisé à chaud	35x100	70034110	12	2309	42,80/pc.
		35x150	70034115	12	2309	47,25/pc.
		35x200	70034120	12	2309	54,71/pc.
		35x300	70034130	12	2309	63,44/pc.
		60x100	70034210	12	2309	44,55/pc.
		60x150	70034215	12	2309	49,35/pc.
		60x200	70034220	12	2309	57,00/pc.
		60x300	70034230	12	2309	76,92/pc.
		60x400	70034240	12	2309	122,67/pc.
		60x500	70034250	12	2309	176,24/pc.
		60x600	70034260	12	2309	202,03/pc.
		85x200	70034320	12	2309	sur demande
		85x300	70034330	12	2309	sur demande
		85x400	70034340	12	2309	sur demande
		85x500	70034350	12	2309	sur demande
		85x600	70034360	12	2309	sur demande
	<b>Couvercle pour croisillon Click</b>					
	Acier galvanisé à chaud	100	73034100	12	2309	36,29/pc.
		150	73034150	12	2309	40,62/pc.
		200	73034200	12	2309	45,35/pc.
		300	73034300	12	2309	74,28/pc.
		400	73034400	12	2309	99,85/pc.
		500	73034500	12	2309	143,44/pc.
	600	73034600	12	2309	163,85/pc.	
	<b>Pièce de montée Click</b>					
	Acier galvanisé à chaud	35x100	70035110	13	2309	36,34/pc.
		35x150	70035115	13	2309	40,56/pc.
		35x200	70035120	13	2309	46,50/pc.
		35x300	70035130	13	2309	53,91/pc.
		60x100	70035210	13	2309	38,23/pc.
		60x150	70035215	13	2309	42,85/pc.
		60x200	70035220	13	2309	48,95/pc.
		60x300	70035230	13	2309	67,61/pc.
		60x400	70035240	13	2309	88,85/pc.
		60x500	70035250	13	2309	103,84/pc.
		60x600	70035260	13	2309	113,25/pc.
		85x200	70035320	13	2309	sur demande
		85x300	70035330	13	2309	sur demande
		85x400	70035340	13	2309	sur demande
		85x500	70035350	13	2309	sur demande
		85x600	70035360	13	2309	sur demande
	<b>Couvercle pour pièce de montée Click</b>					
	Acier galvanisé à chaud	100	73035100	13	2309	30,24/pc.
		150	73035150	13	2309	33,89/pc.
		200	73035200	13	2309	38,74/pc.
		300	73035300	13	2309	63,50/pc.
		400	73035400	13	2309	83,30/pc.
		500	73035500	13	2309	119,64/pc.
	600	73035600	13	2309	119,64/pc.	

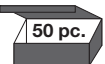

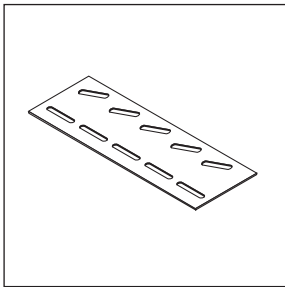
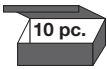
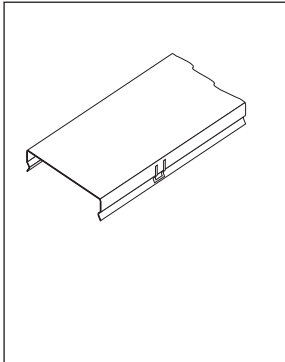
	type	référence	page catal.	groupe d'articles	prix en €	
	<b>Pièce de descente Click</b>					
	Acier galvanisé à chaud	35x100	70036110	13	2309	36,91/pc.
		35x150	70036115	13	2309	41,26/pc.
		35x200	70036120	13	2309	47,25/pc.
		35x300	70036130	13	2309	54,78/pc.
		60x100	70036210	13	2309	38,46/pc.
		60x150	70036215	13	2309	43,08/pc.
		60x200	70036220	13	2309	49,24/pc.
		60x300	70036230	13	2309	60,49/pc.
		60x400	70036240	13	2309	78,77/pc.
		60x500	70036250	13	2309	88,86/pc.
		60x600	70036260	13	2309	92,31/pc.
		85x200	70036320	13	2309	sur demande
		85x300	70036330	13	2309	sur demande
		85x400	70036340	13	2309	sur demande
	85x500	70036350	13	2309	sur demande	
	85x600	70036360	13	2309	sur demande	
	<b>Couvercle pour pièce de descente Click</b>					
	Acier galvanisé à chaud	100	73036100	13	2309	29,05/pc.
		150	73036150	13	2309	32,52/pc.
		200	73036200	13	2309	37,14/pc.
		300	73036300	13	2309	51,98/pc.
		400	73036400	13	2309	79,93/pc.
		500	73036500	13	2309	114,86/pc.
	600	73036600	13	2309	131,23/pc.	
	<b>Dérivation universelle Click</b>					
	Acier galvanisé à chaud	35	70031100	14	2309	18,49/pc.
		60	70031200	14	2309	19,79/pc.
		85	70031300	14	2309	sur demande
	100	70031400	14	2309	sur demande	

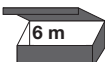
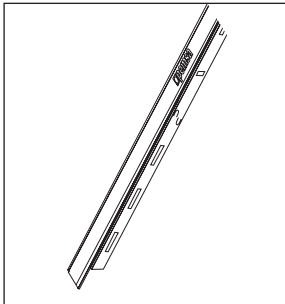

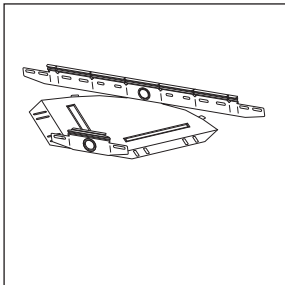
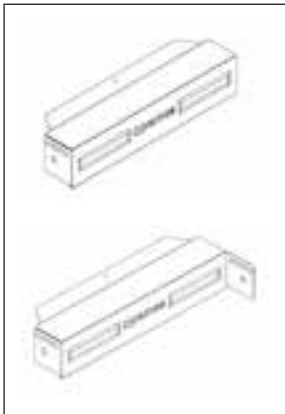

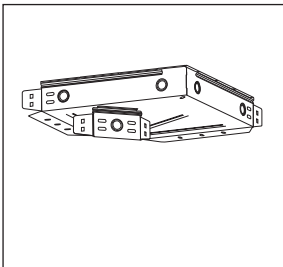
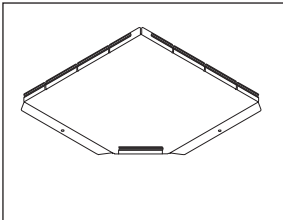
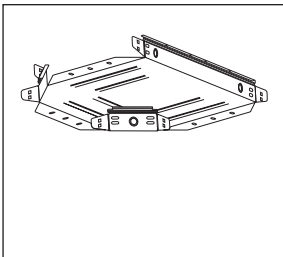
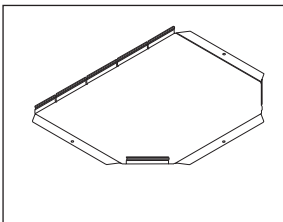
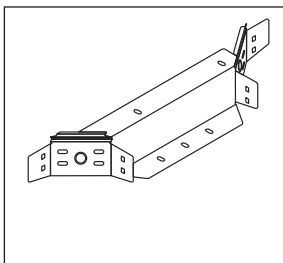
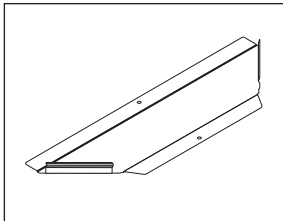

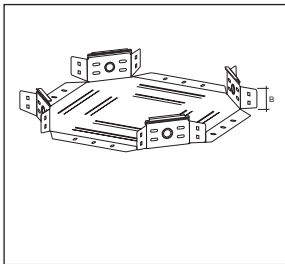
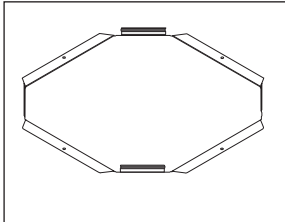
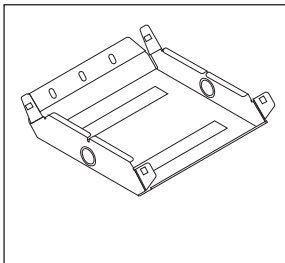
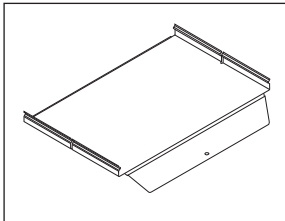
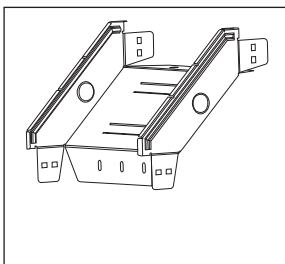
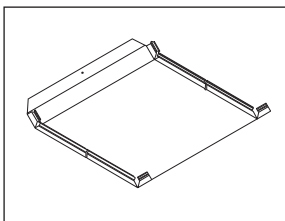

	type	référence	page catal.	groupe d'articles	prix en €	
	<b>Chemin de câbles Pemsaband, H = 60 mm</b>					
	Acier inoxydable AISI 304					
			60x100	76452100	2315	60,69/m
			60x150 60x200	76452150 76452200	2315 2315	61,33/m 84,66/m
			60x300 60x400 60x500 60x600	76452300 76452400 76452500 76452600	2315 2315 2315 2315	106,69/m 108,87/m 149,14/m 188,85/m
	<b>Gaine à câbles Inducanal, H = 60 mm</b>					
	Acier inoxydable AISI 304					
			60x100	76552100	2315	58,99/m
			60x150 60x200	76552150 76552200	2315 2315	61,56/m 84,80/m
			60x300 60x400 60x500 60x600	76552300 76552400 76552500 76552600	2315 2315 2315 2315	106,91/m 109,05/m 149,91/m 189,56/m
	<b>Boulon à collet carré</b>					
		Acier inoxydable AISI 316L	M6x20	67060100	2309	1,59/pc.
						
	<b>Ecrou 6 pans à embase crénelée</b>					
	Acier inoxydable AISI 316L	M6	64060059	2309	0,94/pc.	
						
<b>Accouplement</b>						
	Acier inoxydable AISI 304	60	93950002	2309	7,27/pc.	
<b>Plaque pour pièce de montée/descente</b>						
	Acier inoxydable AISI 304	60	93950012	2309	7,56/pc.	
						
	4 plaques pour 1 pièce de montée/descente.					

	type	référence	page catal.	groupe d'articles	prix en €	
	<b>Accouplement</b>					
	Acier inoxydable AISI 304					
		300	71050300		2309	16,07/pc.
		400	71050400		2309	21,92/pc.
		500	71050500		2309	27,10/pc.
600		71050600		2309	31,63/pc.	
	<b>Couvercle Click</b>					
	Acier inoxydable AISI 304					
		100	73051100		2316	39,51/m
		150	73051150		2316	52,71/m
		200	73051200		2316	64,55/m
		300	73051300		2316	90,22/m
		400	73051400		2316	116,47/m
		500	73051500		2316	126,73/m
		600	73051600		2316	173,80/m
	<b>Cloison de séparation</b>					
	Acier inoxydable 316L					
		50	67060611		2316	40,88/m
						
	<b>Courbe réglable</b>					
	Acier inoxydable AISI 304					
	60x100	70058210		2309	35,80/pc.	
	60x150	70058215		2309	56,77/pc.	
	60x200	70058220		2309	62,62/pc.	
60x300	70058230		2309	105,20/pc.		
	<b>Embout et réduction</b>					
	Acier inoxydable AISI 304					
	60x100	71052010		2309	42,22/pc.	
	60x150	71052015		2309	55,00/pc.	
	60x200	71052020		2309	72,87/pc.	
60x300	71052030		2309	93,92/pc.		



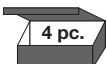
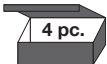

	type	référence	page catal.	groupe d'articles	prix en €
	<b>Courbe Click 90°</b>				
	Acier inoxydable AISI 304	60x100	70050210	2309	46,29/pc.
		60x150	70050215	2309	52,21/pc.
		60x200	70050220	2309	81,10/pc.
		60x300	70050230	2309	105,98/pc.
		60x400	70050240	2309	149,14/pc.
		60x500	70050250	2309	217,03/pc.
	60x600	70050260	2309	219,66/pc.	
	<b>Couvercle pour courbe Click 90°</b>				
	Acier inoxydable AISI 304	100	73050100	2309	49,92/pc.
		150	73050150	2309	59,42/pc.
		200	73050200	2309	82,87/pc.
		300	73050300	2309	89,65/pc.
		400	73050400	2309	162,25/pc.
		500	73050500	2309	203,96/pc.
	600	73050600	2309	209,61/pc.	
	<b>Pièce en T Click</b>				
	Acier inoxydable AISI 304	60x100	70052210	2309	56,85/pc.
		60x150	70052215	2309	62,12/pc.
		60x200	70052220	2309	80,02/pc.
		60x300	70052230	2309	105,98/pc.
		60x400	70052240	2309	214,67/pc.
		60x500	70052250	2309	216,66/pc.
	60x600	70052260	2309	218,31/pc.	
	<b>Couvercle pour pièce en T Click</b>				
	Acier inoxydable AISI 304	100	73052100	2309	67,68/pc.
		150	73052150	2309	84,09/pc.
		200	73052200	2309	106,40/pc.
		300	73052300	2309	139,01/pc.
		400	73052400	2309	268,52/pc.
		500	73052500	2309	292,05/pc.
	600	73052600	2309	286,34/pc.	
	<b>Dérivation Click</b>				
	Acier inoxydable AISI 304	60x100	70053210	2309	41,79/pc.
		60x150	70053215	2309	42,02/pc.
		60x200	70053220	2309	53,57/pc.
		60x300	70053230	2309	53,91/pc.
		60x400	70053240	2309	74,88/pc.
		60x500	70053250	2309	74,96/pc.
	60x600	70053260	2309	75,45/pc.	
	<b>Couvercle pour dérivation Click</b>				
	Acier inoxydable AISI 304	100	73053100	2309	45,50/pc.
		150	73053150	2309	46,92/pc.
		200	73053200	2309	47,72/pc.
		300	73053300	2309	62,26/pc.
		400	73053400	2309	60,12/pc.
		500	73053500	2309	84,16/pc.
	600	73053600	2309	87,15/pc.	

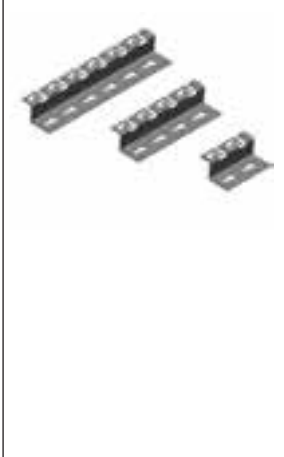
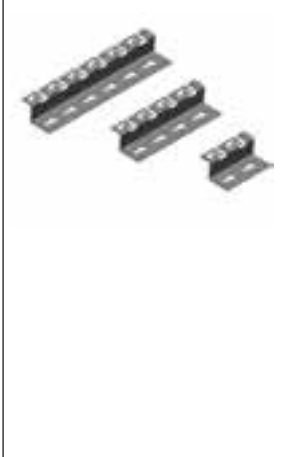
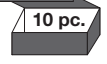
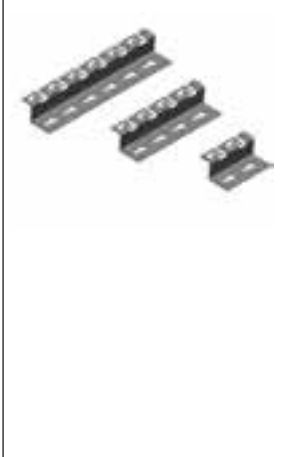
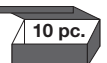
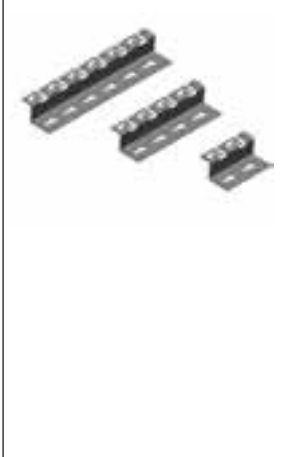
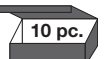
	type	référence	page catal.	groupe d'articles	prix en €
	<b>Croisillon Click</b>				
	Acier inoxydable AISI 304	60x100	70054210	2309	62,33/pc.
		60x150	70054215	2309	90,79/pc.
		60x200	70054220	2309	82,73/pc.
		60x300	70054230	2309	148,05/pc.
		60x400	70054240	2309	214,39/pc.
		60x500	70054250	2309	217,03/pc.
	60x600	70054260	2309	291,20/pc.	
	<b>Couvercle pour croisillon Click</b>				
	Acier inoxydable AISI 304	100	73054100	2309	79,53/pc.
		150	73054150	2309	99,35/pc.
		200	73054200	2309	97,28/pc.
		300	73054300	2309	171,31/pc.
		400	73054400	2309	221,45/pc.
		500	73054500	2309	277,22/pc.
	600	73054600	2309	327,57/pc.	
	<b>Pièce de montée Click</b>				
	Acier inoxydable AISI 304	60x100	70055210	2309	55,06/pc.
		60x150	70055215	2309	64,83/pc.
		60x200	70055220	2309	65,83/pc.
		60x300	70055230	2309	80,59/pc.
		60x400	70055240	2309	102,85/pc.
		60x500	70055250	2309	148,99/pc.
	60x600	70055260	2309	148,99/pc.	
	<b>Couvercle pour pièce de montée Click</b>				
	Acier inoxydable AISI 304	100	73055100	2309	47,79/pc.
		150	73055150	2309	54,06/pc.
		200	73055200	2309	62,98/pc.
		300	73055300	2309	91,51/pc.
		400	73055400	2309	112,39/pc.
		500	73055500	2309	135,72/pc.
	600	73055600	2309	203,05/pc.	
	<b>Pièce de descente Click</b>				
	Acier inoxydable AISI 304	60x100	70056210	2309	40,51/pc.
		60x150	70056215	2309	47,64/pc.
		60x200	70056220	2309	62,98/pc.
		60x300	70056230	2309	77,31/pc.
		60x400	70056240	2309	100,98/pc.
		60x500	70056250	2309	111,11/pc.
	60x600	70056260	2309	121,38/pc.	
	<b>Couvercle pour pièce de descente Click</b>				
	Acier inoxydable AISI 304	100	73056100	2309	68,11/pc.
		150	73056150	2309	71,60/pc.
		200	73056200	2309	88,43/pc.
		300	73056300	2309	113,54/pc.
		400	73056400	2309	173,59/pc.
		500	73056500	2309	237,92/pc.
	600	73056600	2309	301,10/pc.	
	<b>Dérivation universelle Click</b>				
	Acier inoxydable AISI 304	60	70051200	2309	19,48/pc.

# Systemes de suspension – chemins et gaines à câbles

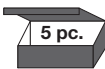
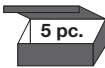
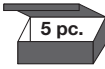

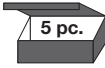
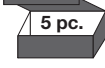
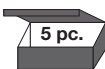

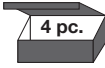
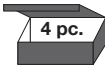
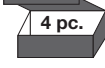
	type	référence	page catal.	groupe d'articles	prix en €	
	<b>RPLUS console Click</b>					
	Acier galvanisé Sendzimir	100	62025103	16	2307	7,37/pc.
		150	62025153	16	2307	8,60/pc.
		200	62025203	16	2307	9,89/pc.
		300	62025303	16	2307	11,33/pc.
		400	62025403	16	2307	16,36/pc.
		500	62025503	16	2307	18,99/pc.
	600	62025603	16	2307	21,60/pc.	
	<b>RPLUS console Click</b>					
	Acier galvanisé à chaud	100	62035103	16	2307	11,39/pc.
		150	62035153	16	2307	12,73/pc.
		200	62035203	16	2307	15,04/pc.
		300	62035303	16	2307	18,62/pc.
		400	62035403	16	2307	20,82/pc.
		500	62035503	16	2307	25,97/pc.
	600	62035603	16	2307	30,21/pc.	
	<b>RPLUS console</b>					
	Acier inoxydable AISI 304	100	62055103		2307	25,63/pc.
		150	62055153		2307	28,25/pc.
		200	62055203		2307	31,60/pc.
		300	62055303		2307	38,37/pc.
		400	62055403		2307	64,28/pc.
		500	62055503		2307	72,54/pc.
	600	62055603		2307	82,41/pc.	
	<b>Kit embout étrier réglable</b>					
	Acier galvanisé à chaud		62037002	16	2307	18,32/pc.
	<b>Kit embout étrier réglable</b>					
	Acier inoxydable AISI 304		62057002		2307	sur demande
	<b>RPLUS distanceur Click</b>					
	Acier galvanisé Sendzimir	100	67020520	16	2307	7,35/pc.
		200	67020522	16	2307	8,78/pc.
		300	67020524	16	2307	10,10/pc.
	<b>RPLUS distanceur Click</b>					
	Acier galvanisé à chaud	100	67030520	16	2307	9,11/pc.
		200	67030522	16	2307	11,58/pc.
		300	67030524	16	2307	13,94/pc.
	<b>RPLUS distanceur Click</b>					
	Acier inoxydable AISI 304	100	67050520		2307	11,35/pc.
		200	67050522		2307	18,74/pc.
		300	67050524		2307	25,79/pc.

# Systemes de suspension – chemins et gaines à câbles



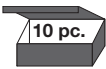
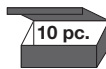

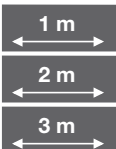
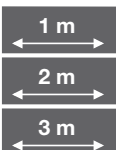

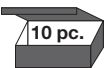
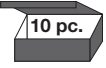



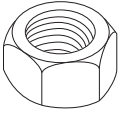

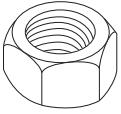

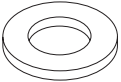

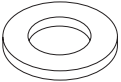

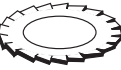

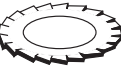
	type	référence	page catal.	groupe d'articles	prix en €	
	<b>SPLUS console Oméga Click</b>					
	Acier galvanisé Sendzimir	100	62021104	17	2307	5,90/pc.
		150	62021154	17	2307	7,63/pc.
		200	62021204	17	2307	8,74/pc.
		300	62021304	17	2307	10,30/pc.
		400	62021404	17	2307	15,41/pc.
		<b>SPLUS console Oméga Click</b>				
	Acier galvanisé à chaud	100	62031104	17	2307	9,03/pc.
		150	62031154	17	2307	11,55/pc.
		200	62031204	17	2307	12,38/pc.
300		62031304	17	2307	13,24/pc.	
400		62031404	17	2307	20,44/pc.	
<b>SPLUS console Oméga Click</b>						
Acier inoxydable AISI 304	100	62051104		2307	18,67/pc.	
	150	62051154		2307	23,16/pc.	
	200	62051204		2307	29,13/pc.	
	300	62051304		2307	35,31/pc.	
	400	62051404		2307	42,95/pc.	
		<b>SPLUS pendard Oméga</b>				
Acier galvanisé Sendzimir		500	62021504	18	2307	17,61/pc.
		600	62021604	18	2307	21,00/pc.
		<b>SPLUS pendard Oméga</b>				
Acier galvanisé à chaud		500	62031504	18	2307	23,71/pc.
		600	62031604	18	2307	28,38/pc.
		<b>SPLUS pendard Oméga</b>				
Acier inoxydable AISI 304		500	62051504		2307	49,63/pc.
		600	62051604		2307	56,48/pc.
			<b>SPLUS étrier en C Oméga Click</b>			
Acier galvanisé Sendzimir	100		62022104	17	2307	11,65/pc.
	150		62022154	17	2307	12,24/pc.
	200		62022204	17	2307	13,16/pc.
	300		62022304	17	2307	15,41/pc.
	400		62022404	17	2307	22,73/pc.
<b>SPLUS étrier en C Oméga Click</b>						
Acier galvanisé à chaud	100		62032104	17	2307	15,41/pc.
	150		62032154	17	2307	16,94/pc.
	200		62032204	17	2307	18,91/pc.
	300	62032304	17	2307	22,66/pc.	
	400	62032404	17	2307	34,65/pc.	
<b>SPLUS étrier en C Oméga Click</b>						
Acier inoxydable AISI 304	100	62052104		2307	31,86/pc.	
	150	62052154		2307	34,56/pc.	
	200	62052204		2307	45,43/pc.	
	300	62052304		2307	52,20/pc.	
	400	62052404		2307	60,33/pc.	

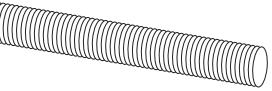

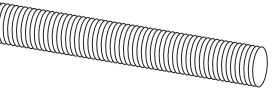
# Systemes de suspension – chemins et gaines à câbles

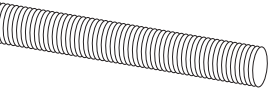
	type	référence	page catal.	groupe d'articles	prix en €	
	<b>SPLUS console Oméga Click</b>					
	Acier galvanisé Sendzimir	100	63022104	17	2307	4,00/pc.
		150	63022154	17	2307	4,41/pc.
		200	63022204	17	2307	5,53/pc.
		300	63022304	17	2307	6,51/pc.
		400	63022404	17	2307	8,80/pc.
		500	63022504	17	2307	9,91/pc.
		600	63022604	17	2307	13,11/pc.
	<b>SPLUS console Oméga Click</b>					
	Acier galvanisé à chaud	100	63032104	17	2307	6,64/pc.
		150	63032154	17	2307	7,10/pc.
		200	63032204	17	2307	8,69/pc.
		300	63032304	17	2307	10,42/pc.
400		63032404	17	2307	12,65/pc.	
500		63032504	17	2307	14,94/pc.	
600		63032604	17	2307	17,88/pc.	
	<b>SPLUS profilé Oméga Click</b>					
	Acier galvanisé Sendzimir					
		1 m	67020110	17	2307	26,55/m
		2 m	67020111	17	2307	26,55/m
		3 m	67020112	17	2307	26,55/m
	<b>SPLUS profilé Oméga Click</b>					
	Acier galvanisé à chaud					
		1 m	67030110	17	2307	43,28/m
		2 m	67030111	17	2307	43,28/m
		3 m	67030112	17	2307	43,28/m
	<b>Etrier intérieur avec écrou M10</b>					
	Acier galvanisé Sendzimir	100	70122210	2309	6,70/pc.	
		150	70122215	2309	8,12/pc.	
		200	70122220	2309	9,43/pc.	
		300	70122230	2309	12,18/pc.	
		400	70122240	2309	14,81/pc.	
		<b>Etrier intérieur avec écrou M10</b>				
	Acier galvanisé à chaud	100	70132210	2309	9,33/pc.	
		150	70132215	2309	11,30/pc.	
		200	70132220	2309	13,38/pc.	
300		70132230	2309	17,34/pc.		
400		70132240	2309	21,17/pc.		

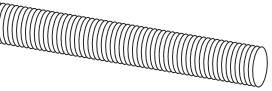
# Systemes de suspension – chemins et gaines à câbles

	type	référence	page catal.	groupe d'articles	prix en €
	<b>Ecrou hexagonal</b>				
	Acier à zingage électrolytique	M8	67020095	2307	0,15/pc.
		M10	67020079	2307	0,17/pc.
					
	<b>Ecrou hexagonal</b>				
	Acier inoxydable AISI 304	M8	67060062	2307	1,01/pc.
		M10	67060014	2307	2,32/pc.
					
	<b>Rondelle</b>				
	Acier à zingage électrolytique	M8	67020083	2307	0,08/pc.
		M10	67020061	2307	0,18/pc.
					
	<b>Rondelle</b>				
	Acier inoxydable AISI 316	M8	67060063	2307	0,51/pc.
		M10	67060064	2307	0,75/pc.
					
	<b>Rondelle étoilée</b>				
	Acier inoxydable	M8	67020084	2307	0,24/pc.
					
	<b>Rondelle étoilée</b>				
	Acier inoxydable	M10	67020086	2307	0,33/pc.
					
	<b>Tige filetée</b>				
	Acier à zingage électrolytique	M6	67010140	2307	2,75/pc.
					
	<b>Tige filetée</b>				
	Acier inoxydable AISI 316	M8	67060044	2307	26,59/pc.
					
	<b>Tige filetée</b>				
	Acier à zingage électrolytique	M6	67010141	2307	3,52/m
					
	<b>Tige filetée</b>				
	Acier inoxydable AISI 316	M8	67060045	2307	34,72/m
		M10	67060145	2307	43,56/m
					



# Systemes de support de câbles en matière composite



Le polyester renforcé de fibres de verre (Glass Reinforced Polymer) offre une excellente résistance au feu et à la corrosion. En outre, il ne subit aucune modification en cas de variations de température ou de conditions climatiques défavorables et la gamme est stable aux UV. C'est pourquoi le polyester renforcé de fibres de verre est la solution la plus rentable à long terme.

Notre gamme de produits renforcés de fibres de verre se compose de gaines (fermées), de chemins de câbles (perforés) et d'échelles à câbles. De plus, nous proposons ces systèmes dans une gamme étendue de résines, en fonction de l'utilisation prévue.

## Application:

- Chemins de fer
- Exploitation pétrolière et gazière
- Pétrochimie
- Navigation
- Tunnels
- Traitement des déchets

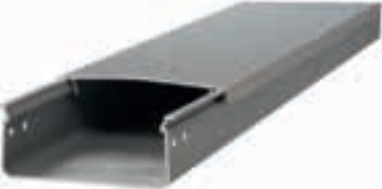

	<p><b>Gaine à câbles (fermée) ou chemin de câbles (perforé)</b></p> <p>Hauteur : 60 - 80 - 110 mm            Largeur : 100 - 150 - 200 - 300 - 400 mm            Longueur : 3000 mm</p>
	<p><b>Echelles à câbles</b></p> <p>Hauteur : 100 - 135 - 150 mm            Largeur : 150 jusqu'à 1000 mm            Longueur : 3000 - 6000 mm</p>
	<p><b>Profilés</b></p> <p>Dimensions : 28 x 38 mm            41,5 x 41,5 mm            85 x 43,5 mm (double)            Longueur : 3000 mm</p>





# rejiband<sup>®</sup> treillis à câbles

## Gamme étendue des exécutions et traitements de surface

- ✓ zingage électrolytique
- ✓ zingage électrolytique, bichromaté
- ✓ galvanisation Sendzimir
- ✓ Black C8, Résistance Haute Protection, CLASS 8 IEC 61537
- ✓ acier inoxydable AISI 304 ou AISI 316

## Système CLICK

- ✓ consoles et accessoires

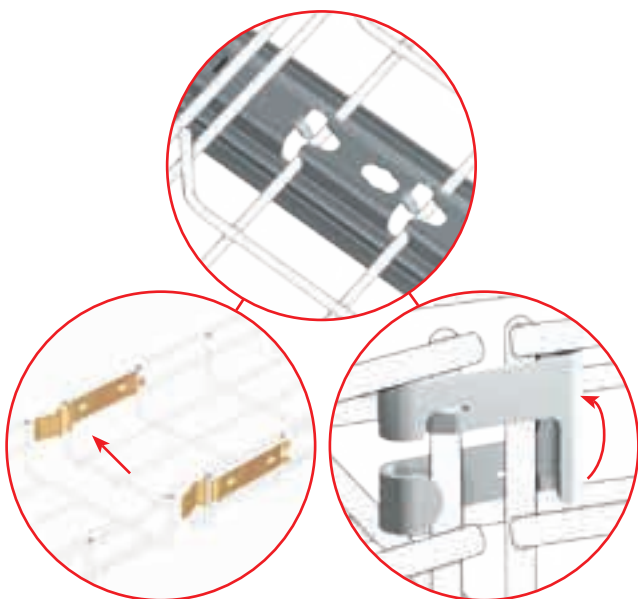

## Embouts de sécurité

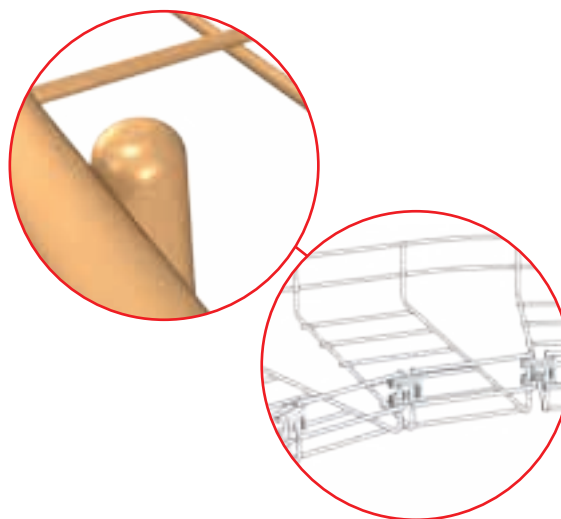

## Système simple

- ✓ système à couper, courber et connecter
- ✓ nombre d'accessoires limité
- ✓ gain de temps et de montage

NOUVEAU DANS L'ASSORTIMENT

# rejiband® BLACK C8®

Durée (heure),  
essai au brouillard salin,  
ASTIM-B117

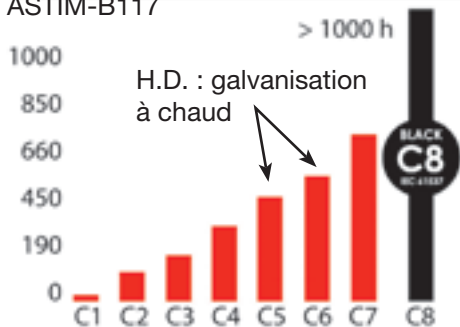

- ✓ une protection élevée contre la corrosion
- ✓ une finition esthétique de haute qualité – un revêtement lisse et régulier
- ✓ libre de membranes de zinc et de particules de zinc libres
- ✓ écologique

# rejiband® CLICK®



### Le système le plus rapide :

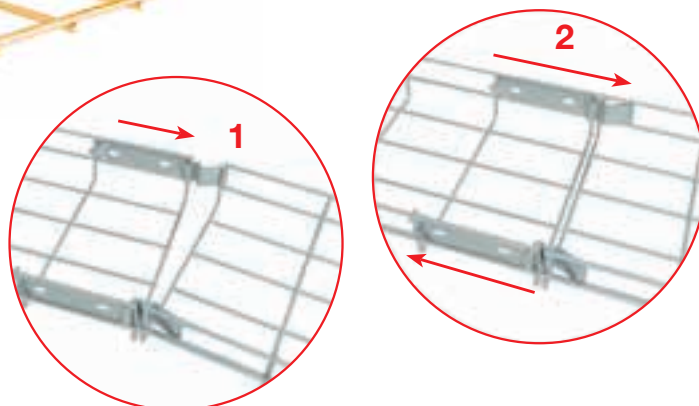

- ✓ une installation en deux étapes
- ✓ 40% de gain de temps
- ✓ 30% plus économique





# rejiband® G+



- ✓ installation rapide avec étrier
- ✓ directement au plafond
- ✓ pas besoin des étriers en C

rejiband®				rejitech®	
rejiband®	rejiband®	rejiband® black C8	rejiband® click	rejitech® rejitech G+®	treillis angulaire
					

Caractéristiques						
E.Z.	✓				✓	
Z.B.		✓		✓	✓	✓
H.D.		✓			✓	✓
C8			✓		✓	
INOX 304		✓				✓
 mm	60-600	60-600	60-600	60-600	60-200	109
 mm	35-60	35/60/100	35-60	60	60-100	60
L mm	3000	3000	3000	3000	2000-3000	3000
 N/m						
		E90				
Applications						
 Tertiaire	✓	✓	✓	✓	✓	✓
 Tunnels	✓	✓	✓			
 Centres de donnée	✓	✓	✓	✓	✓	✓
 Installations PV	✓	✓	✓			
 Industrie alimentaire	✓	✓				
 Petrochimie	✓	✓				
 E.Z.	page 77-78	-	-	-	page 92	-
 Z.B.	-	page 77-79	-	page 79	page 92	page 93
 H.D.	-	page 77-79	-	-	-	page 93
 C8	-	-	page 77-78	-	-	-
 INOX 304	-	page 77-79	-	-	-	page 93

**E.Z.** zingage électrolytique NBN EN ISO 2081 – recommandé dans les environnements corrosifs C1 (très faible)  
**Z.B.** zingage électrolytique, bichromaté NBN EN ISO 2081 – recommandé dans les environnements corrosifs C2 (faible)  
**H.D.** galvanisation à chaud NBN EN ISO 1461 – recommandé dans les environnements corrosifs C3/C4 (moyen/haut)  
**C8** Black C8, Protection Haute Résistance, recommandé dans les environnements corrosifs C5-I (très haut – industrie)  
**INOX 304** acier inoxydable AISI 304 – recommandé dans les environnements corrosifs C5-I (très haut – industrie)

 voir page 2





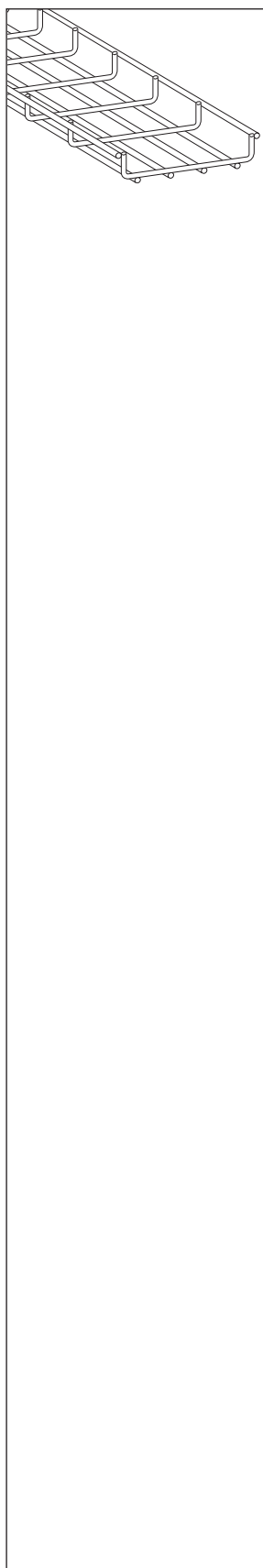





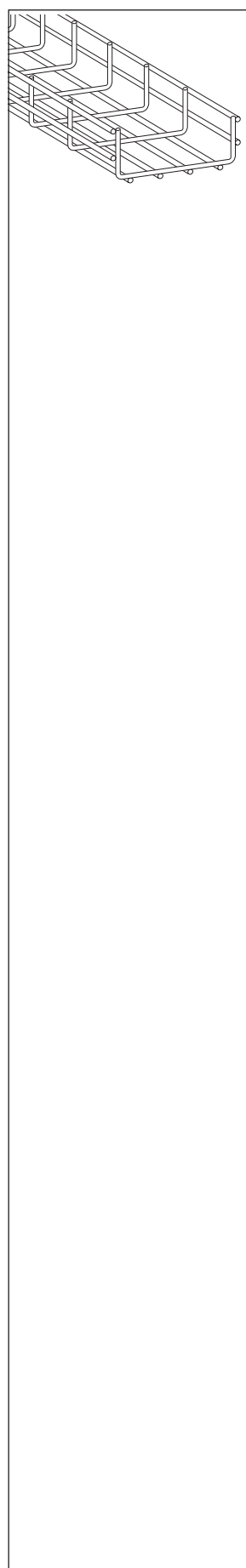



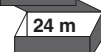







# Treillis à câbles













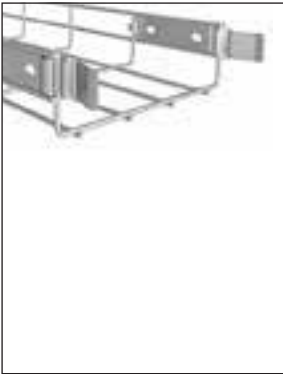







	type	référence	page catal.	groupe d'articles	prix en €	
<b>Treillis à câbles Rejiband 35</b>						
Acier à zingage électrolytique						
		35 x 60	60211060		2304	8,83/m
		35 x 100	60211100		2304	9,11/m
		35 x 150	60211150		2304	12,80/m
		35 x 200	60211200		2304	13,99/m
		35 x 300	60211300		2304	20,09/m
		35 x 400	60211400		2304	25,18/m
	<b>Treillis à câbles Rejiband 35</b>					
	Acier à zingage électrolytique, bichromaté					
			35 x 60	60221060		2301
35 x 100			60221100	6	2301	9,11/m
35 x 150			60221150	6	2301	12,80/m
		35 x 200	60221200	6	2301	13,99/m
		35 x 300	60221300	6	2301	20,09/m
		35 x 400	60221400	6	2301	25,18/m
<b>Treillis à câbles Rejiband 35</b>						
Acier galvanisé à chaud						
			35 x 60	60231060		2305
	35 x 100		60231100	6	2305	11,72/m
	35 x 150		60231150	6	2305	15,15/m
		35 x 200	60231200	6	2305	17,21/m
		35 x 300	60231300	6	2305	23,83/m
		35 x 400	60231400	6	2305	28,34/m
	<b>Treillis à câbles Rejiband 35</b>					
	Black C8					
			35 x 60	60281060		2306
35 x 100			60281100		2306	10,32/m
35 x 150			60281150		2306	13,33/m
		35 x 200	60281200		2306	15,15/m
		35 x 300	60281300		2306	20,97/m
		35 x 400	60281400		2306	24,94/m
<b>Treillis à câbles Rejiband 35</b>						
Acier inoxydable AISI 304						
		 recommandé	35 x 60	60251060		2302
	35 x 100		60251100	6	2302	35,72/m
	35 x 150		60251150	6	2302	42,52/m
	 recommandé	35 x 200	60251200	6	2302	55,04/m
		35 x 300	60251300	6	2302	72,77/m
	 recommandé	35 x 400	60251400	6	2302	109,09/m

# Treillis à câbles



	type	référence	page catal.	groupe d'articles	prix en €		
<b>Treillis à câbles Rejiband 60</b>							
Acier à zingage électrolytique 	 24 m	60 x 60	60212060		2304	8,34/m	
		60 x 100	60212100		2304	10,68/m	
		60 x 150	60212150		2304	13,20/m	
	 18 m	60 x 200	60212200		2304	14,97/m	
		60 x 300	60212300		2304	19,42/m	
		60 x 400	60212400		2304	27,90/m	
	 12 m	60 x 500	60212500		2304	34,47/m	
		60 x 600	60212600		2304	40,84/m	
		60 x 600	60212600		2304	40,84/m	
	<b>Treillis à câbles Rejiband 60</b>						
	Acier à zingage électrolytique, bichromaté 	 24 m	60 x 60	60222060	6	2301	8,87/m
			60 x 100	60222100	6	2301	11,61/m
			60 x 150	60222150	6	2301	14,35/m
		 18 m	60 x 200	60222200	6	2301	16,28/m
			60 x 300	60222300	6	2301	21,11/m
60 x 400			60222400	6	2301	30,33/m	
 12 m		60 x 500	60222500	6	2301	37,46/m	
		60 x 600	60222600	6	2301	44,40/m	
		60 x 600	60222600	6	2301	44,40/m	
<b>Treillis à câbles Rejiband 60</b>							
Acier galvanisé à chaud 		 24 m	60 x 60	60232060	6	2305	12,00/m
			60 x 100	60232100	6	2305	16,23/m
			60 x 150	60232150	6	2305	20,09/m
		 18 m	60 x 200	60232200	6	2305	23,78/m
			60 x 300	60232300	6	2305	32,52/m
	60 x 400		60232400	6	2305	42,95/m	
	 12 m	60 x 500	60232500	6	2305	50,66/m	
		60 x 600	60232600	6	2305	59,78/m	
		60 x 600	60232600	6	2305	59,78/m	
	<b>Treillis à câbles Rejiband 60</b>						
	Black C8 	 24 m recommandé	60 x 60	60282060		2306	10,57/m
			60 x 100	60282100		2306	14,31/m
			60 x 150	60282150		2306	17,68/m
		 18 m recommandé	60 x 200	60282200		2306	20,94/m
			60 x 300	60282300		2306	28,61/m
60 x 400			60282400		2306	37,79/m	
 12 m recommandé		60 x 500	60282500		2306	44,57/m	
		60 x 600	60282600		2306	52,60/m	
		60 x 600	60282600		2306	52,60/m	
<b>Treillis à câbles Rejiband 60</b>							
Acier inoxydable AISI 304 		 24 m recommandé	60 x 60	60252060	6	2302	36,06/m
			60 x 100	60252100	6	2302	49,11/m
			60 x 150	60252150	6	2302	58,18/m
		 18 m recommandé	60 x 200	60252200	6	2302	66,99/m
			60 x 300	60252300	6	2302	84,67/m
	60 x 400		60252400	6	2302	105,86/m	
	 12 m recommandé	60 x 500	60252500	6	2302	125,24/m	
		60 x 600	60252600	6	2302	142,32/m	
		60 x 600	60252600	6	2302	142,32/m	

# Treillis à câbles

	type	référence	page catal.	groupe d'articles	prix en €	
	<b>Treillis à câbles Rejiband Click 60</b>					
	Acier à zingage électrolytique, bichromaté					
			60 x 60	60522060	2301	11,82/m
			60 x 100	60522100	2301	15,24/m
			60 x 150	60522150	2301	18,68/m
			60 x 200	60522200	2301	20,24/m
			60 x 300	60522300	2301	25,62/m
			60 x 400	60522400	2301	37,04/m
			60 x 500	60522500	2301	45,00/m
			60 x 600	60522600	2301	53,27/m
	<b>Accouplement treillis à câbles Rejiband Click</b>					
	Acier à zingage électrolytique, bichromaté					
		4	64020038	2307	2,72/pc.	
		5	64020040	2307	2,72/pc.	
	<b>Treillis à câbles Rejiband 100</b>					
	Acier à zingage électrolytique, bichromaté					
			100 x 100	60223100	2301	20,70/m
			100 x 150	60223150	2301	25,40/m
			100 x 200	60223200	6 2301	27,85/m
			100 x 300	60223300	6 2301	33,33/m
			100 x 400	60223400	6 2301	43,56/m
			100 x 500	60223500	6 2301	52,30/m
			100 x 600	60223600	6 2301	53,45/m
	<b>Treillis à câbles Rejiband 100</b>					
Acier galvanisé à chaud						
		100 x 100	60233100	2305	25,59/m	
		100 x 150	60233150	2305	28,45/m	
		100 x 200	60233200	6 2305	37,17/m	
		100 x 300	60233300	6 2305	47,31/m	
		100 x 400	60233400	6 2305	57,72/m	
		100 x 500	60233500	6 2305	67,35/m	
		100 x 600	60233600	6 2305	71,90/m	
<b>Treillis à câbles Rejiband 100</b>						
Acier inoxydable AISI 304						
		100 x 100	60253100	2302	61,67/m	
		100 x 150	60253150	2302	69,49/m	
		100 x 200	60253200	6 2302	87,94/m	
		100 x 300	60253300	6 2302	106,00/m	
		100 x 400	60253400	6 2302	124,45/m	
		100 x 500	60253500	6 2302	144,46/m	
		100 x 600	60253600	6 2302	161,82/m	

# Treillis à câbles



## Accouplement renforcé 61

Acier à zingage électrolytique 64010061 2307 1,46/pc.

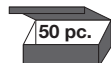

## Accouplement renforcé 61

Acier à zingage électrolytique, bichromaté 64020061 7 2307 1,46/pc.



## Accouplement renforcé 61

Acier galvanisé à chaud 64030061 7 2307 2,06/pc.

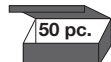

## Accouplement renforcé 61

Black C8 64080061 2307 2,06/pc.



## Accouplement renforcé 61

Acier inoxydable AISI 316 64060061 7 2307 5,98/pc.

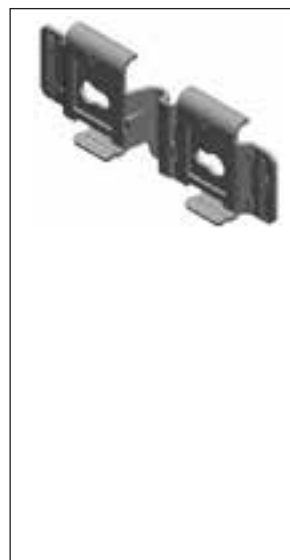

## Accouplement Click

Acier à zingage électrolytique 64010035 2307 2,17/pc.



## Accouplement Click

Acier à zingage électrolytique, bichromaté 64020035 7 2307 2,17/pc.

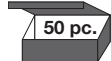

## Accouplement Click

Acier galvanisé à chaud 64030035 7 2307 3,05/pc.



## Accouplement Click

Black C8 64080035 2307 3,05/pc.



## Accouplement de fond Click

Acier à zingage électrolytique 64010036 2307 3,11/pc.



## Accouplement de fond Click

Acier à zingage électrolytique, bichromaté 64020036 7 2307 3,11/pc.



## Accouplement de fond Click

Acier galvanisé à chaud 64030036 7 2307 4,34/pc.



## Accouplement de fond Click

Black C8 64080036 2307 4,34/pc.



# Treillis à câbles

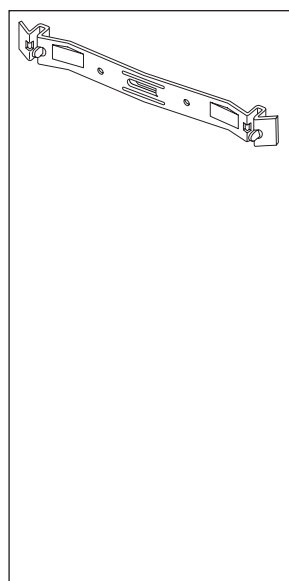

## Accouplement Click

Acier à zingage électrolytique

référence 64010020

page  
catal.

groupe  
d'articles

prix  
en €

2307 3,87/pc.



## Accouplement Click

Acier à zingage électrolytique,  
bichromaté

référence 64020030

7

2307

3,87/pc.



## Accouplement Click

Acier galvanisé à chaud

référence 64030030

7

2307

4,62/pc.



## Accouplement Click

Black C8

référence 64080030

2307

4,62/pc.



## Accouplement au flanc 41

Acier à zingage électrolytique

référence 64010041

2307

1,38/pc.



## Accouplement au flanc 41

Acier à zingage électrolytique,  
bichromaté

référence 64020041

9

2307

1,38/pc.



## Accouplement au flanc 41

Acier galvanisé à chaud

référence 64030041

9

2307

2,18/pc.



## Accouplement au flanc 41

Black C8

référence 64080041

2307

2,18/pc.



## Accouplement au flanc 41

Acier inoxydable AISI 316

référence 64060041

9

2307

7,49/pc.

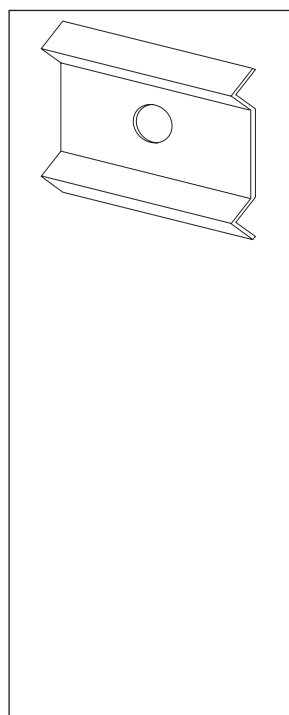









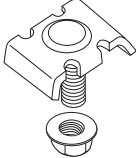

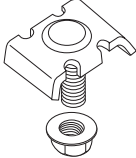
# Treillis à câbles

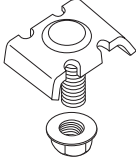
	type	référence	page catal.	groupe d'articles	prix en €
	<b>Multi-éclisse</b>				
	Acier à zingage électrolytique	L = 300 mm 67010053		2307	4,22/pc.
					
	<b>Multi-éclisse</b>				
	Acier à zingage électrolytique, bichromaté	L = 300 mm 67020053	9	2307	4,22/pc.
					
	<b>Multi-éclisse</b>				
	Acier galvanisé à chaud	L = 300 mm 67030047	9	2307	6,78/pc.
					
	<b>Multi-éclisse</b>				
	Black C8	L = 300 mm 67080053		2307	6,78/pc.
					
	<b>Multi-éclisse</b>				
	Acier inoxydable AISI 316	L = 300 mm 67060053	9	2307	12,49/pc.
					
	<b>Borne de terre</b>				
	Cuivre	16-35 mm <sup>2</sup> 68000032	10	2307	8,87/pc.
					
	<b>Borne de terre</b>				
	Cuivre	16-50 mm <sup>2</sup> 68000034	10	2309	5,58/pc.
					
	<b>Accouplement courbe Click</b>				
	Acier à zingage électrolytique	64010072		2307	1,32/pc.
					
	<b>Accouplement courbe Click</b>				
	Acier à zingage électrolytique, bichromaté	64020072	8	2307	1,32/pc.
					
	<b>Accouplement courbe Click</b>				
	Acier galvanisé à chaud	64030072	8	2307	1,82/pc.
					
	<b>Accouplement courbe Click</b>				
	Black C8	64080072		2307	1,82/pc.
					

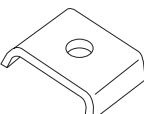
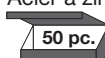
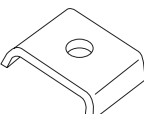
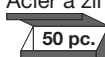

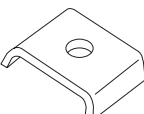





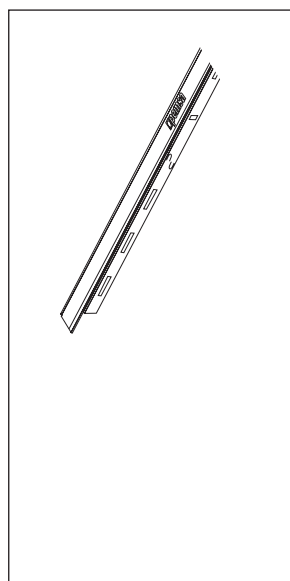
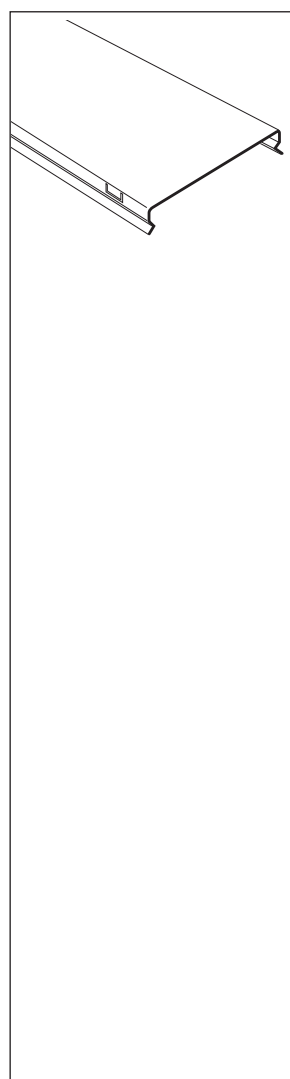







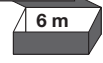

# Treillis à câbles











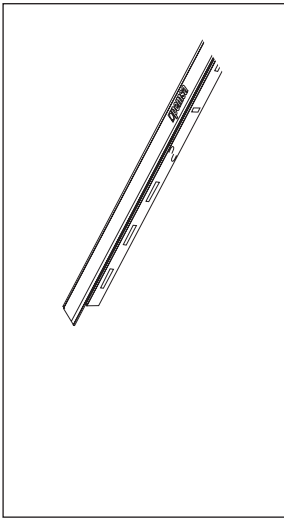

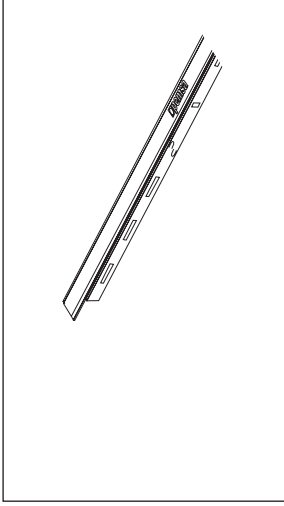
	type	référence	page catal.	groupe d'articles	prix en €
	<b>Accouplement 60</b>				
	Acier à zingage électrolytique	64010060		2307	1,07/pc.
	 50 pc.				
	<b>Accouplement 60</b>				
	Acier à zingage électrolytique, bichromaté	64020060	8	2307	1,07/pc.
	 50 pc.				
	<b>Accouplement 60</b>				
	Acier galvanisé à chaud	64030060	8	2307	1,61/pc.
	 50 pc.				
	<b>Accouplement 60</b>				
	Black C8	64080060		2307	1,61/pc.
	 50 pc.				
	<b>Accouplement 60</b>				
	Acier inoxydable AISI 316	64060060	8	2307	4,10/pc.
	 50 pc.				
	<b>Plaque d'accouplement 62</b>				
	Acier à zingage électrolytique	64010062		2307	0,58/pc.
	 50 pc.				
	<b>Plaque d'accouplement 62</b>				
	Acier à zingage électrolytique, bichromaté	64020062	8	2307	0,58/pc.
	 50 pc.				
	<b>Plaque d'accouplement 62</b>				
	Acier galvanisé à chaud	64030062	8	2307	0,61/pc.
	 50 pc.				
	<b>Plaque d'accouplement 62</b>				
	Acier inoxydable AISI 316	64060062	8	2307	2,15/pc.
	 50 pc.				

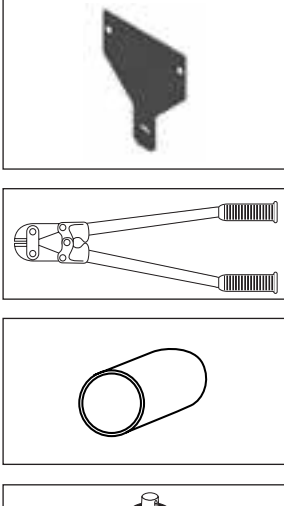
# Treillis à câbles

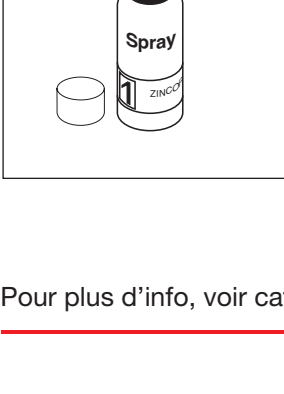









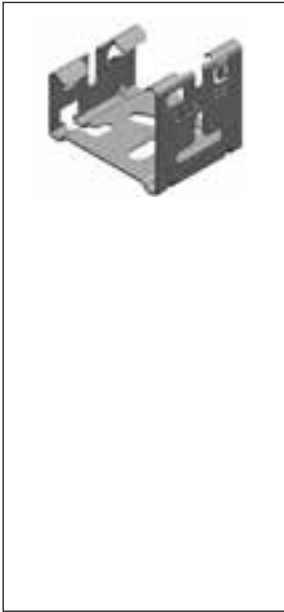

	type	référence	page catal.	groupe d'articles	prix en €	
<b>Couvercle Click</b>						
Acier galvanisé Sendzimir						
		60	73021060	6	2316	6,64/m
		100	73021100	6	2316	8,57/m
		150	73021150	6	2316	11,11/m
		200	73021200	6	2316	13,52/m
		300	73021300	6	2316	20,63/m
		400	73021400	6	2316	26,43/m
		500	73021500	6	2316	35,79/m
		600	73021600	6	2316	42,01/m
	<b>Couvercle Click</b>					
	Acier galvanisé à chaud					
		60	73031060	6	2316	11,13/m
		100	73031100	6	2316	15,52/m
		150	73031150	6	2316	21,11/m
		200	73031200	6	2316	26,71/m
		300	73031300	6	2316	40,62/m
		400	73031400	6	2316	52,60/m
		500	73031500	6	2316	64,58/m
		600	73031600	6	2316	76,56/m
	<b>Couvercle Click</b>					
	Acier inoxydable AISI 304					
		60	73051060	6	2316	27,96/m
		100	73051100	6	2316	39,51/m
		150	73051150	6	2316	52,71/m
		200	73051200	6	2316	64,55/m
		300	73051300	6	2316	90,22/m
		400	73051400	6	2316	116,47/m
		500	73051500	6	2316	126,73/m
		600	73051600	6	2316	173,80/m
	<b>Cloison de séparation H = 25 mm</b>					
	Acier galvanisé Sendzimir					
			67020610	10	2316	6,61/m
<b>Cloison de séparation H = 25 mm</b>						
Acier galvanisé à chaud						
			67030610	10	2316	9,07/m
<b>Cloison de séparation H = 25 mm</b>						
Acier inoxydable AISI 316						
			67060610	10	2316	30,35/m











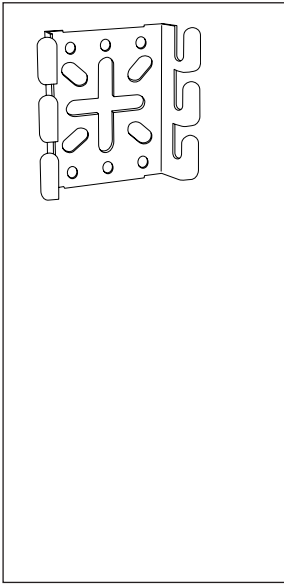
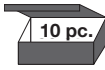
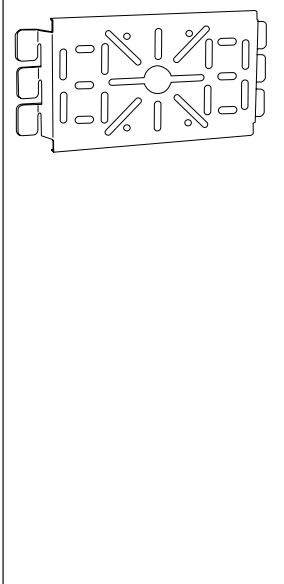

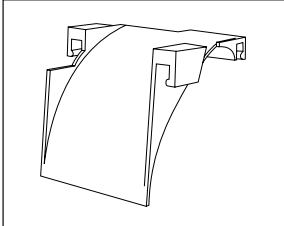
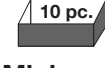

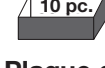
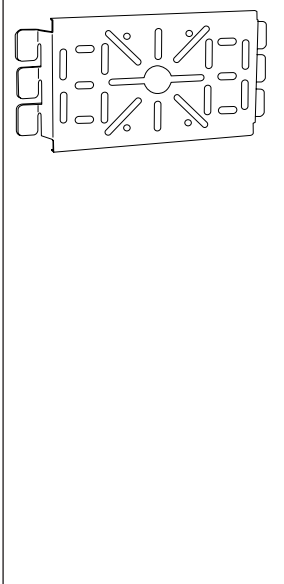
# Treillis à câbles

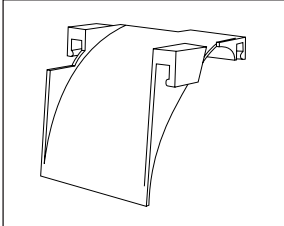
	type	référence	page catal.	groupe d'articles	prix en €
	<b>Cloison de séparation, H = 50 mm</b>				
	Acier galvanisé Sendzimir	67020611	10	2316	7,43/m
	 				
	<b>Cloison de séparation, H = 50 mm</b>				
	Acier galvanisé à chaud	67030611	10	2316	12,32/m
	 				
	<b>Cloison de séparation, H = 50 mm</b>				
	Acier inoxydable AISI 316	67060611	10	2316	40,88/m
	 				
	<b>Cloison de séparation, H = 80 mm</b>				
	Acier galvanisé Sendzimir	67020612	10	2316	13,07/m
	 				
	<b>Cloison de séparation, H = 80 mm</b>				
	Acier galvanisé à chaud	67030612	10	2316	17,35/m
	 				
	<b>Plaque d'identification</b>				
	Matière synthétique rouge	68000020	10	2307	1,10/pc.
					
	<b>Cisaille pour treillis à câbles</b>				
	450x140	68000058	8	2307	262,78/pc.
	<b>Embout de finition</b>				
	Matière synthétique noir	68000049	9	2307	0,42/pc.
					
	<b>Galvanospray 0,4l</b>				
	Zinc	68000052	9	2307	53,46/pc.
	<b>Galvanospray 0,4l</b>				
	Black C8	68000053		2307	91,93/pc.



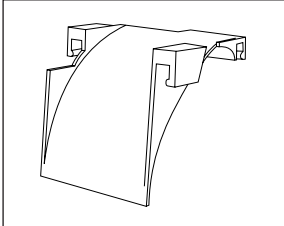

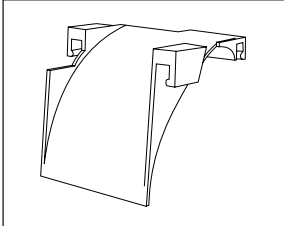









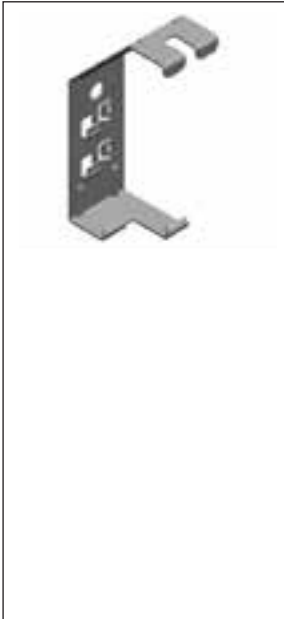





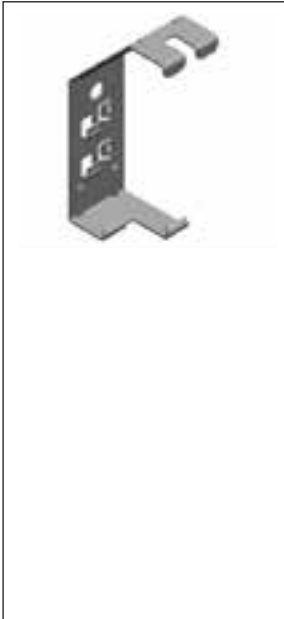

# Treillis à câbles

	type	référence	page catal.	groupe d'articles	prix en €
	<b>Support pour boîte de montage</b>				
	Matière synthétique rouge	68000040	20	2307	1,33/pc.
					
	<b>Etrier pour éclairage ou boîte de distribution</b>				
	Acier à zingage électrolytique	67010030		2307	8,07/pc.
					
	<b>Etrier pour éclairage ou boîte de distribution</b>				
Acier à zingage électrolytique, bichromaté	67020030	20	2307	8,07/pc.	
					
<b>Etrier pour éclairage ou boîte de distribution</b>					
Acier galvanisé à chaud	67030030	20	2307	8,87/pc.	
					
<b>Etrier pour éclairage ou boîte de distribution</b>					
Black C8	67080030		2307	8,87/pc.	
					
	<b>Bande auto-adhésive Rejifix</b>				
	ABS noir	89011000	20	2307	132,20/pc.
	1 pc. = 25 m				
	<b>Support pour câbles</b>				
	ABS rouge	68000010	20	2307	1,90/pc.
					
	<b>Plaquette d'identification</b>				
	Polypropylène	89010000	21	2307	1,22/pc.
					

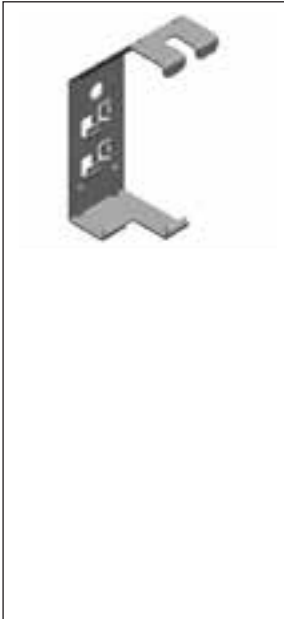
# Treillis à câbles

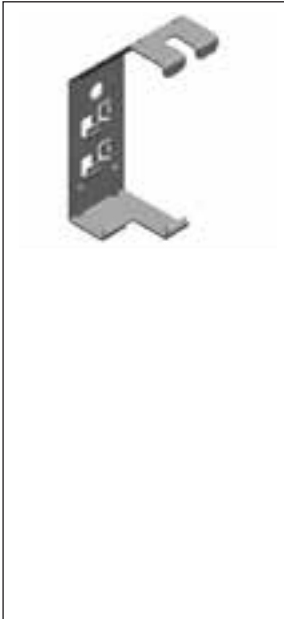

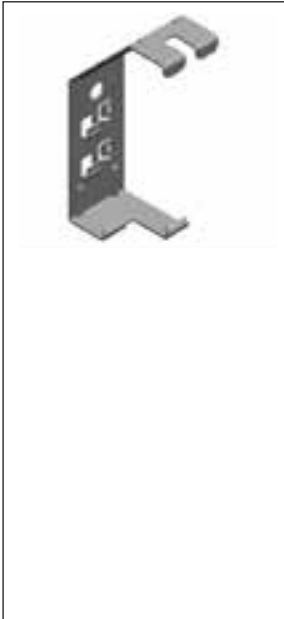







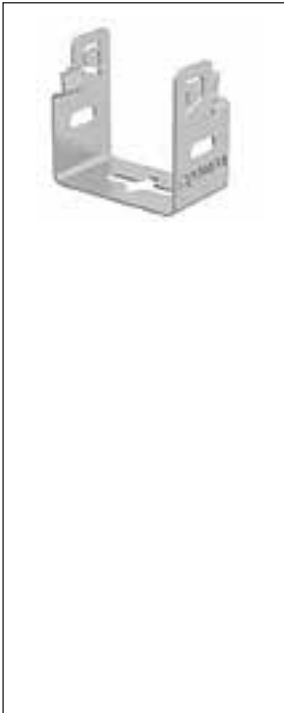

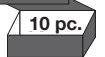

	type	référence	page catal.	groupe d'articles	prix en €	
	<b>Mini-support universel</b>					
	Acier galvanisé Sendzimir	87x65	62026010	13	2307	3,07/pc.
						
	<b>Mini-support universel</b>					
	Acier galvanisé à chaud	87x65	62036010	13	2307	6,58/pc.
						
	<b>Mini-support universel</b>					
	Black C8	87x65	62086010		2307	6,58/pc.
						
	<b>Mini-support universel</b>					
	Acier inoxydable AISI 316	87x65	62066010	13	2307	11,65/pc.
						
	<b>Plaque de montage</b>					
	Acier galvanisé Sendzimir	109x170	62026011	13	2307	5,71/pc.
						
	<b>Plaque de montage</b>					
	Acier galvanisé à chaud	109x170	62036011	13	2307	10,04/pc.
						
	<b>Plaque de montage</b>					
	Black C8	109x170	62086011		2307	10,04/pc.
						
	<b>Plaque de montage</b>					
	Acier inoxydable AISI 316	109x170	62066011	13	2307	24,42/pc.
						
	<b>Sortie pour câbles optiques</b>					
	Matière synthétique rouge		67020039	21	2307	3,96/pc.
	<b>Sortie pour câbles</b>					
	Acier galvanisé Sendzimir		67010016		2307	7,30/pc.
	<b>Sortie pour câbles</b>					
	Acier galvanisé à chaud		67030016		2307	12,18/pc.

# Treillis à câbles

	type	référence	page catal.	groupe d'articles	prix en €
	<b>Etrier avec sorties pour tubes</b>				
	Acier à zingage électrolytique	67010040		2307	4,52/pc.
					
	<b>Etrier avec sorties pour tubes</b>				
	Acier à zingage électrolytique, bichromaté	67020040	21	2307	4,52/pc.
					
	<b>Etrier avec sorties pour tubes</b>				
	Black C8	67080040		2307	6,44/pc.
					
	<b>Etrier mural léger</b>				
	Acier à zingage électrolytique	62016021		2307	1,71/pc.
					
	<b>Etrier mural léger</b>				
	Acier à zingage électrolytique, bichromaté	62026021	15	2307	1,71/pc.
					
	<b>Etrier mural léger</b>				
	Acier galvanisé à chaud	62036021	15	2307	2,85/pc.
					
	<b>Etrier mural léger</b>				
	Black C8	62086021		2307	2,85/pc.
					
	<b>Etrier de plafond léger</b>				
	Acier à zingage électrolytique	62016020		2307	6,85/pc.
					
	<b>Etrier de plafond léger</b>				
	Acier à zingage électrolytique, bichromaté	62026020	15	2307	6,85/pc.
					
	<b>Etrier de plafond léger</b>				
	Acier galvanisé à chaud	62036020	15	2307	10,20/pc.
					
	<b>Etrier de plafond léger</b>				
	Black C8	62086020		2307	10,20/pc.
					



# Treillis à câbles

	type	référence	page catal.	groupe d'articles	prix en €	
	<b>Support de fond 60</b>					
	Acier à zingage électrolytique	100x63	62016022	2307	5,65/pc.	
						
	<b>Support de fond 60</b>					
	Acier à zingage électrolytique, bichromaté	100x63	62026022	15	2307	5,65/pc.
						
<b>Support de fond 60</b>						
Acier galvanisé à chaud	100x63	62036022	15	2307	7,52/pc.	
						
<b>Support de fond 60</b>						
Black C8	100x63	62086022		2307	7,52/pc.	
						
<b>Support de fond 60</b>						
Acier inoxydable AISI 316	100x63	62066022	15	2307	14,83/pc.	
						
	<b>Support pour flanc 60</b>					
	Acier à zingage électrolytique	104x30	62011060		2307	2,93/pc.
						
	<b>Support pour flanc 60</b>					
	Acier à zingage électrolytique, bichromaté	104x30	62021060	14	2307	2,93/pc.
						
<b>Support pour flanc 60</b>						
Acier galvanisé à chaud	104x30	62031060	14	2307	3,94/pc.	
						
<b>Support pour flanc 60</b>						
Black C8	104x30	62081060		2307	3,94/pc.	
						
<b>Support pour flanc 60</b>						
Acier inoxydable AISI 316	104x30	62061060	14	2307	7,06/pc.	
						
	<b>Accouplement pour treillis / profilé</b>					
	Acier galvanisé à chaud		67030049	21	2307	2,39/pc.
						

# Treillis à câbles

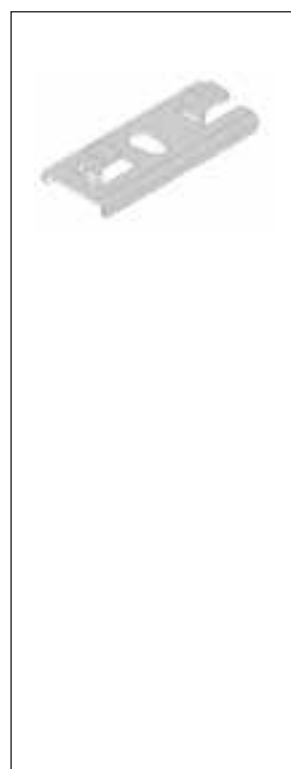

## Suspension centrale Click

Acier à zingage électrolytique



type	référence
M6	67010143
M8/M10	67010043

page catal.	groupe d'articles	prix en €
2307		3,64/pc.
2307		3,64/pc.

## Suspension centrale Click

Acier à zingage électrolytique, bichromaté

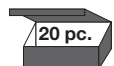

type	référence
M6	67020143
M8/M10	67020043

page catal.	groupe d'articles	prix en €
14	2307	3,64/pc.
14	2307	3,64/pc.

## Suspension centrale Click

Acier galvanisé à chaud

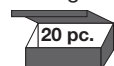

type	référence
M6	67030143
M8/M10	67030043

page catal.	groupe d'articles	prix en €
14	2307	4,54/pc.
14	2307	4,54/pc.

## Suspension centrale Click

Black C8



type	référence
M6	67080143
M8/M10	67080043

page catal.	groupe d'articles	prix en €
2307		4,54/pc.
2307		4,54/pc.

## Suspension centrale Click

Acier inoxydable AISI 316

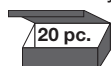

type	référence
M6	67060143
M8/M10	67060043

page catal.	groupe d'articles	prix en €
14	2307	8,50/pc.
14	2307	8,50/pc.

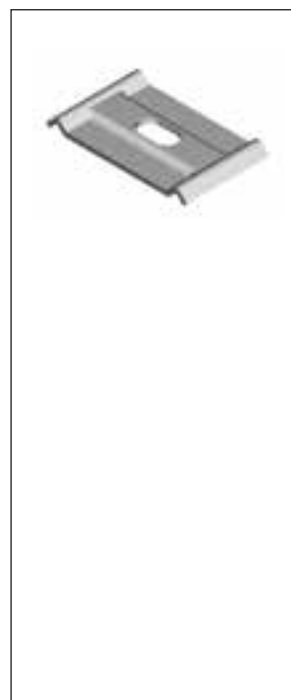

## Suspension centrale

Acier à zingage électrolytique

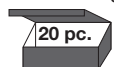

type	référence
M6	67010144
M8/M10	67010046

page catal.	groupe d'articles	prix en €
2307		1,42/pc.
2307		1,23/pc.

## Suspension centrale

Acier à zingage électrolytique, bichromaté



type	référence
M8/M10	67020046

page catal.	groupe d'articles	prix en €
14	2307	1,23/pc.

## Suspension centrale

Acier galvanisé à chaud

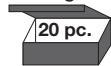

type	référence
M8/M10	67030046

page catal.	groupe d'articles	prix en €
14	2307	2,10/pc.

## Suspension centrale

Black C8

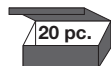

type	référence
M8/M10	67080046

page catal.	groupe d'articles	prix en €
2307		2,10/pc.

## Suspension centrale











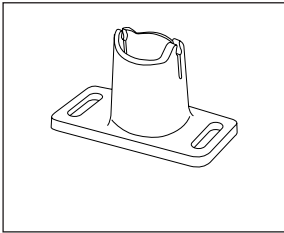

Acier inoxydable AISI 316

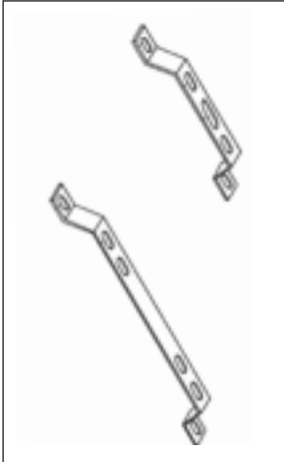

type	référence
M8/M10	67060046

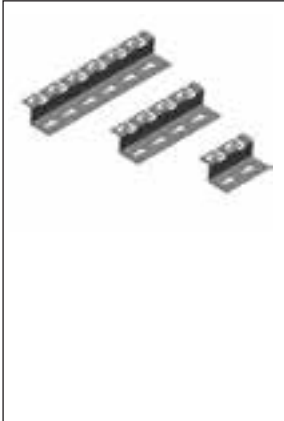

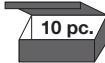





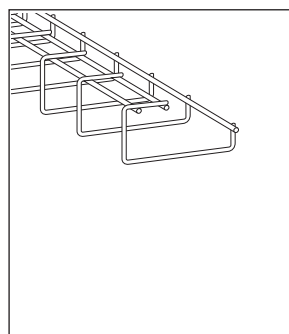



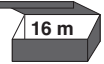



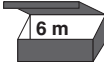

page catal.	groupe d'articles	prix en €
14	2307	3,21/pc.

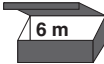
# Treillis à câbles



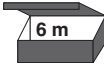





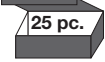
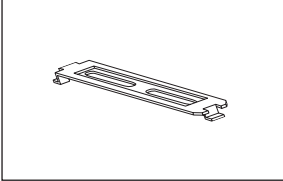
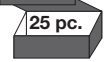
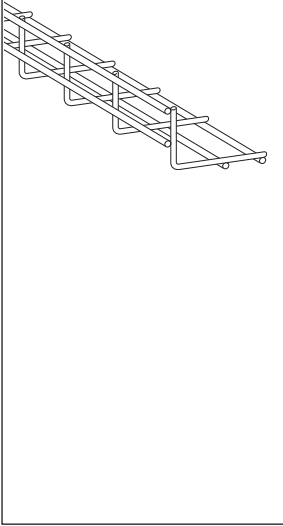

	type	référence	page catal.	groupe d'articles	prix en €	
	<b>Pied d'appui</b>					
	Matière synthétique rouge	68000060	12	2307	2,79/pc.	
	 100 pc.					
	Hauteur 40 mm empilable.					
	<b>Adhésif pour pied (2 x 4 kg)</b>					
		68000066	12	2307	279,91/pc.	
	Adhésif + durcisseur suffisant pour env. 400 pieds d'appui.					
	<b>Roofsupport</b>					
	Matière synthétique/beton	60102011		2307	196,84/set	
	1 set = 20 supports					
	<b>Distanceur</b>					
	Acier galvanisé Sendzimir	180	67030539	12	2307	7,58/pc.
		350	67030540	12	2307	9,52/pc.
	 10 pc.					
	<b>Distanceur</b>					
	Acier galvanisé à chaud	180	67030541	12	2307	13,44/pc.
		350	67030542	12	2307	15,45/pc.
	 10 pc.					
	<b>Distanceur</b>					
	Acier inoxydable AISI 316	180	67060541	12	2307	37,63/pc.
	350	67060542	12	2307	51,51/pc.	
 10 pc.						
	<b>RPLUS distanceur Click</b>					
	Acier galvanisé Sendzimir	100	67020520	17	2307	7,35/pc.
		200	67020522	17	2307	8,78/pc.
		300	67020524	17	2307	10,10/pc.
	 10 pc.					
	<b>RPLUS distanceur Click</b>					
	Acier galvanisé à chaud	100	67030520	17	2307	9,11/pc.
		200	67030522	17	2307	11,58/pc.
		300	67030524	17	2307	13,94/pc.
	 10 pc.					
<b>RPLUS distanceur Click</b>						
Acier inoxydable AISI 304	100	67050520	17	2307	11,35/pc.	
	200	67050522	17	2307	18,74/pc.	
	300	67050524	17	2307	25,79/pc.	
 10 pc.						

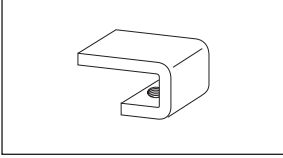
# Treillis de plafond et treillis angulaire

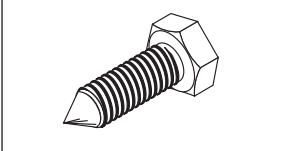

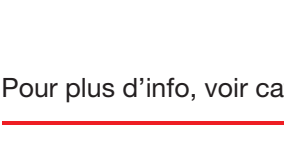
	type	référence	page catal.	groupe d'articles	prix en €	
<b>Treillis de plafond Rejitech</b>						
	Acier à zingage électrolytique	60 x 100	60215020	2304	15,85/m	
						
<b>Treillis de plafond Rejitech</b>						
	Acier à zingage électrolytique, bichromaté	60 x 100	60225020	6 2301	15,85/m	
						
<b>Treillis de plafond Rejitech G+</b>						
	Acier à zingage électrolytique					
			60 x 60 100 x 60	60613206 60613306	2304 2304	14,85/m 17,40/m
			100 x 100	60613310	2304	21,69/m
			100 x 150 100 x 200	60613315 60613320	2304 2304	23,59/m 28,03/m
<b>Treillis de plafond Rejitech G+</b>						
	Acier à zingage électrolytique, bichromaté					
			60 x 60 100 x 60	60623206 60623306	2301 2301	15,29/m 17,91/m
			100 x 100	60623310	2301	22,35/m
			100 x 150 100 x 200	60623315 60623320	2301 2301	24,32/m 28,83/m
<b>Treillis de plafond Rejitech G+</b>						
	Acier galvanisé à chaud					
			60 x 60 100 x 60	60633206 60633306	2305 2305	21,91/m 26,72/m
			100 x 100	60633310	2305	31,52/m
			100 x 150 100 x 200	60633315 60633320	2305 2305	33,63/m 41,35/m
<b>Treillis de plafond Rejitech G+</b>						
	Black C8					
			60 x 60 100 x 60	60683206 60683306	2306 2306	19,29/m 23,51/m
			100 x 100	60683310	2306	27,74/m
			100 x 150 100 x 200	60683315 60683320	2306 2306	29,56/m 36,40/m

# Treillis de plafond et treillis angulaire

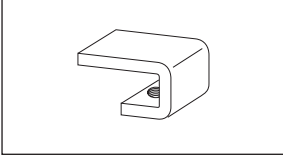
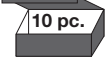
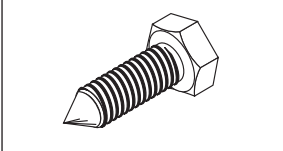
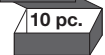
	type	référence	page catal.	groupe d'articles	prix en €	
	<b>Etrier pour treillis de plafond Rejitech et Rejitech G+</b>					
	Acier à zingage électrolytique	67010052		2307	1,86/pc.	
						
	<b>Etrier pour treillis de plafond Rejitech et Rejitech G+</b>					
	Acier à zingage électrolytique, bichromaté	67020052	11	2307	1,86/pc.	
						
	<b>Etrier pour treillis de plafond Rejitech et Rejitech G+</b>					
	Acier galvanisé à chaud	67030252	11	2307	2,55/pc.	
						
	<b>Etrier pour treillis de plafond Rejitech et Rejitech G+</b>					
	Black C8	67080252	11	2307	2,55/pc.	
						
	<b>Support pour boîte de montage pour treillis de plafond Rejitech</b>					
	Acier à zingage électrolytique, bichromaté	67020041	11	2307	12,70/pc.	
						
	<b>Treillis angulaire</b>					
	Acier à zingage électrolytique, bichromaté	60 x 109	60220000	6	2301	12,59/m
						
	<b>Treillis angulaire</b>					
	Acier galvanisé à chaud	60 x 109	60230000	6	2305	15,59/m
						
	<b>Treillis angulaire</b>					
	Acier inoxydable AISI 304	60 x 109	60250000	6	2302	29,89/m
						
	<b>Etrier pour treillis angulaire</b>					
	Acier à zingage électrolytique, bichromaté	67020051	13	2307	9,16/pc.	
						
	<b>Vis hexagonale à pointe conique</b>					
	Acier à zingage électrolytique, bichromaté	M10x20	67020098	13	2307	1,68/pc.
						

# Systemes de suspension – treillis à câbles



## SPLUS console Oméga Click

	type	référence	page catal.	groupe d'articles	prix en €	
	Acier galvanisé Sendzimir	100	62021104	18	2307	5,90/pc.
		150	62021154	18	2307	7,63/pc.
		200	62021204	18	2307	8,74/pc.
		300	62021304	18	2307	10,30/pc.
		400	62021404	18	2307	15,41/pc.

## SPLUS onsole Oméga Click

	Acier galvanisé à chaud	100	62031104	18	2307	9,03/pc.
		150	62031154	18	2307	11,55/pc.
		200	62031204	18	2307	12,38/pc.
		300	62031304	18	2307	13,24/pc.
		400	62031404	18	2307	20,44/pc.

## SPLUS console Oméga Click

	Black C8	100	62081104		2307	9,03/pc.
		150	62081154		2307	11,55/pc.
		200	62081204		2307	12,38/pc.
		300	62081304		2307	13,24/pc.
		400	62081404		2307	20,44/pc.

## SPLUS console Oméga Click

	Acier inoxydable AISI 304	100	62051104	18	2307	18,67/pc.
		150	62051154	18	2307	23,16/pc.
		200	62051204	18	2307	29,13/pc.
		300	62051304	18	2307	35,31/pc.
		400	62051404	18	2307	42,95/pc.

## SPLUS étrier en C Oméga Click

	Acier galvanisé Sendzimir	100	62022104	18	2307	11,65/pc.
		150	62022154	18	2307	12,24/pc.
		200	62022204	18	2307	13,16/pc.
		300	62022304	18	2307	15,41/pc.
		400	62022404	18	2307	22,73/pc.

## SPLUS étrier en C Oméga Click

	Acier galvanisé à chaud	100	62032104	18	2307	15,41/pc.
		150	62032154	18	2307	16,94/pc.
		200	62032204	18	2307	18,91/pc.
		300	62032304	18	2307	22,66/pc.
		400	62032404	18	2307	34,65/pc.

## SPLUS étrier en C Oméga Click







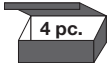

	Black C8	100	62082104		2307	15,41/pc.
		150	62082154		2307	16,94/pc.
		200	62082204		2307	18,91/pc.
		300	62082304		2307	22,66/pc.
		400	62082404		2307	34,65/pc.

## SPLUS étrier en C Oméga Click

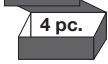
	Acier inoxydable AISI 304	100	62052104	18	2307	31,86/pc.
		150	62052154	18	2307	34,56/pc.
		200	62052204	18	2307	45,43/pc.
		300	62052304	18	2307	52,20/pc.
		400	62052404	18	2307	60,33/pc.

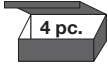

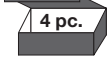
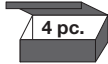
# Systemes de suspension – treillis à câbles







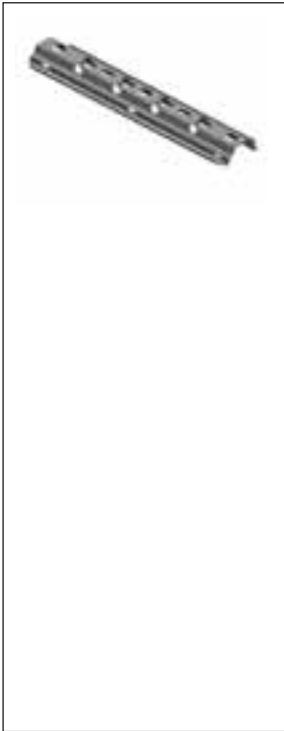
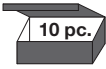
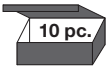
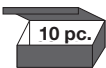
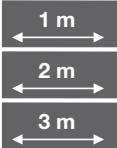
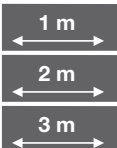
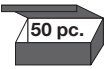
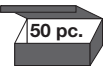



	type	référence	page catal.	groupe d'articles	prix en €		
	<b>RPLUS console Click</b>						
	Acier galvanisé Sendzimir	100	62025103	17	2307	7,37/pc.	
		150	62025153	17	2307	8,60/pc.	
		200	62025203	17	2307	9,89/pc.	
		300	62025303	17	2307	11,33/pc.	
		400	62025403	17	2307	16,36/pc.	
		500	62025503	17	2307	18,99/pc.	
600		62025603	17	2307	21,60/pc.		
	<b>RPLUS console Click</b>						
	Acier galvanisé à chaud	100	62035103	17	2307	11,39/pc.	
		150	62035153	17	2307	12,73/pc.	
		200	62035203	17	2307	15,04/pc.	
		300	62035303	17	2307	18,62/pc.	
		400	62035403	17	2307	20,82/pc.	
		500	62035503	17	2307	25,97/pc.	
600		62035603	17	2307	30,21/pc.		
	<b>RPLUS console Click</b>						
	Black C8	100	62085103		2307	11,39/pc.	
		150	62085153		2307	12,73/pc.	
		200	62085203		2307	15,04/pc.	
		300	62085303		2307	18,62/pc.	
		400	62085403		2307	20,82/pc.	
		500	62085503		2307	25,97/pc.	
600		62085603		2307	30,21/pc.		
	<b>RPLUS console</b>						
	Acier inoxydable AISI 304	100	62055103	17	2307	25,63/pc.	
		150	62055153	17	2307	28,25/pc.	
		200	62055203	17	2307	31,60/pc.	
		300	62055303	17	2307	38,37/pc.	
			400	62055403	17	2307	64,28/pc.
			500	62055503	17	2307	72,54/pc.
600			62055603	17	2307	82,41/pc.	
	<b>Kit embout étrier réglable</b>						
	Acier galvanisé à chaud		62037002	17	2307	18,32/pc.	
	<b>Kit embout étrier réglable</b>						
	Acier inoxydable AISI 304		62057002	17	2307	sur demande	



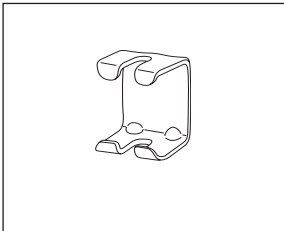

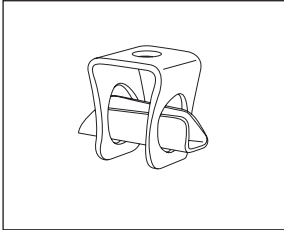
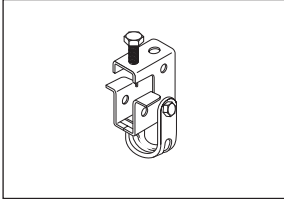



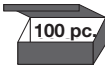
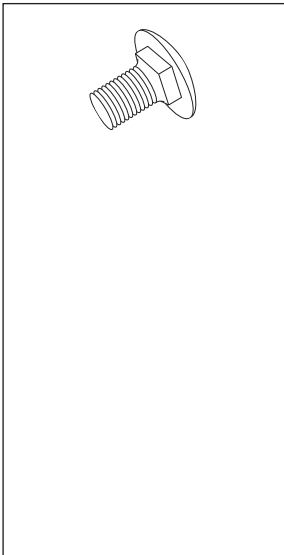
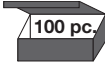
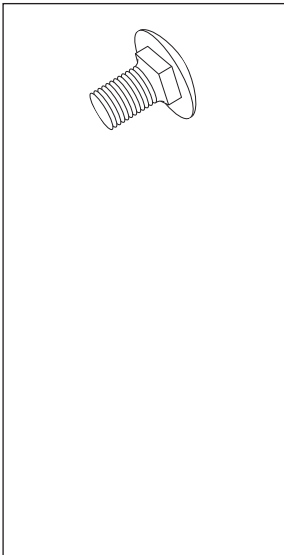

# Systemes de suspension – treillis à câbles

	type	référence	page catal.	groupe d'articles	prix en €	
	<b>SPLUS console Oméga Click</b>					
	Acier galvanisé Sendzimir	100	63022104	18	2307	4,00/pc.
		150	63022154	18	2307	4,41/pc.
		200	63022204	18	2307	5,53/pc.
		300	63022304	18	2307	6,51/pc.
		400	63022404	18	2307	8,80/pc.
		500	63022504	18	2307	9,91/pc.
		600	63022604	18	2307	13,11/pc.
	<b>SPLUS console Oméga Click</b>					
	Acier galvanisé à chaud	100	63032104	18	2307	6,64/pc.
		150	63032154	18	2307	7,10/pc.
		200	63032204	18	2307	8,69/pc.
300		63032304	18	2307	10,42/pc.	
400		63032404	18	2307	12,65/pc.	
500		63032504	18	2307	14,94/pc.	
600		63032604	18	2307	17,88/pc.	
<b>SPLUS console Oméga Click</b>						
Black C8	100	63082104	18	2307	8,47/pc.	
	150	63082154	18	2307	8,58/pc.	
	200	63082204	18	2307	8,69/pc.	
	300	63082304	18	2307	10,42/pc.	
	400	63082404	18	2307	12,65/pc.	
	500	63082504	18	2307	14,94/pc.	
	600	63082604	18	2307	17,88/pc.	
	<b>SPLUS profilé Oméga Click</b>					
	Acier galvanisé Sendzimir					
		1 m	67020110	18	2307	26,55/m
		2 m	67020111	18	2307	26,55/m
		3 m	67020112	18	2307	26,55/m
	<b>SPLUS profilé Oméga Click</b>					
	Acier galvanisé à chaud					
		1 m	67030110	18	2307	43,28/m
		2 m	67030111	18	2307	43,28/m
		3 m	67030112	18	2307	43,28/m
	<b>SPLUS protecteur Oméga Click</b>					
	Matière synthétique rouge		62031084	19	2307	0,93/pc.
						
<b>SPLUS cheville Oméga</b>						
Matière synthétique rouge		62031085	19	2307	0,46/pc.	
						

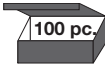
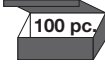
# Systemes de suspension – treillis à câbles

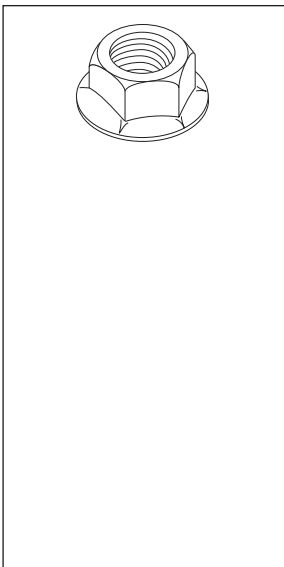
	type	référence	page catal.	groupe d'articles	prix en €	
	<b>SPLUS pendard Oméga</b>					
	Acier galvanisé Sendzimir	500	62021504	19	2307	17,61/pc.
		600	62021604	19	2307	21,00/pc.
						
	<b>SPLUS pendard Oméga</b>					
	Acier galvanisé à chaud	500	62031504	19	2307	23,71/pc.
		600	62031604	19	2307	28,38/pc.
						
	<b>SPLUS pendard Oméga</b>					
	Black C8	500	62081504		2307	23,71/pc.
	600	62081604		2307	28,38/pc.	
						
<b>SPLUS pendard Oméga</b>						
Acier inoxydable AISI 304	500	62051504	19	2307	49,63/pc.	
	600	62051604	19	2307	56,48/pc.	
						
	<b>Etrier de plafond, ouvert</b>					
	Acier galvanisé Sendzimir		67030060		2307	3,35/pc.
						
	<b>Etrier de plafond, réglable</b>					
	Acier galvanisé à chaud		67030061		2307	7,98/pc.
	<b>Agrafe pour poutre en I</b>					
	Acier à zingage électrolytique		67020048		2307	34,47/pc.
	<b>Support panneau sandwich</b>					
	Acier galvanisé Sendzimir	45	67020020	15	2307	4,77/pc.
		90	67020120	15	2307	5,16/pc.
						
	<b>Support panneau sandwich</b>					
	Acier galvanisé à chaud	45	67030020	15	2307	7,69/pc.
	90	67030120	15	2307	8,23/pc.	
						

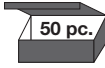
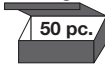
# Systemes de suspension – treillis à câbles

	type	référence	page catal.	groupe d'articles	prix en €	
	<b>Boulon à collet carré et écrou 6 pans à embase crénelée</b>					
	Acier à zingage électrolytique	M6x12	67010093	2309	0,33/pc.	
						
	<b>Boulon à collet carré et écrou 6 pans à embase crénelée</b>					
	Acier galvanisé à chaud	M6x12	67030093	2309	0,46/pc.	
						
	<b>Boulon à collet carré</b>					
	Acier à zingage électrolytique	M6x12	67010099	24	2309	0,24/pc.
		M6x20	67010100	24	2309	0,24/pc.
						
	<b>Boulon à collet carré</b>					
	Acier à zingage électrolytique, bichromaté	M6x20	67020100	24	2307	0,24/pc.
						
	<b>Boulon à collet carré</b>					
	Acier galvanisé à chaud	M6x12	67030099		2309	0,28/pc.
		M6x20	67030100	24	2309	0,41/pc.
	M6x30	67030109	24	2309	0,41/pc.	
						
<b>Boulon à collet carré</b>						
Acier inoxydable AISI 316	M6x20	67060100	24	2309	1,59/pc.	
						
	<b>Ecrou 6 pans à embase crénelée</b>					
	Acier à zingage électrolytique	M6	64010059	24	2309	0,18/pc.
						
	<b>Ecrou 6 pans à embase crénelée</b>					
	Acier à zingage électrolytique, bichromaté	M6	64020059	24	2307	0,18/pc.
						
	<b>Ecrou 6 pans à embase crénelée</b>					
	Acier galvanisé à chaud	M6	64030059	24	2309	0,23/pc.
						
	<b>Ecrou 6 pans à embase crénelée</b>					
Acier inoxydable AISI 316	M6	64060059	24	2309	0,94/pc.	
						

# Systemes de suspension – treillis à câbles

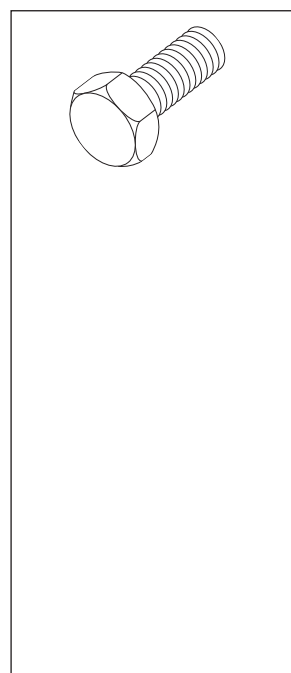

## Boulon

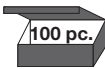
	type	référence	page catal.	groupe d'articles	prix en €	
	Acier à zingage électrolytique	M6x15	67020054	24	2307	0,23/pc.
		M8x15	67010068	24	2307	0,40/pc.
		M8x20	67010065	24	2307	0,46/pc.
		M8X35	67010066	24	2307	0,62/pc.
		M8x65	67020092	24	2307	0,77/pc.
		M10x20	67020059	24	2307	0,77/pc.
		M10x35	67020077	24	2307	1,00/pc.
		M10x60	67020010	24	2307	1,56/pc.

## Boulon

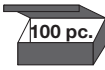
	type	référence	page catal.	groupe d'articles	prix en €	
	Acier galvanisé à chaud	M8x15	67030068	24	2307	0,61/pc.
		M8x20	67030065	24	2307	0,57/pc.
		M8X35	67030066	24	2307	0,80/pc.
		M10x20	67030059	24	2307	1,03/pc.
		M10x35	67030077	24	2307	1,52/pc.
		M10x60	67030010	24	2307	2,34/pc.

## Boulon

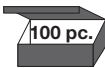
	type	référence	page catal.	groupe d'articles	prix en €	
	Acier inoxydable AISI 316	M8x20	67060065	24	2307	0,98/pc.
		M8X35	67060066	24	2307	1,72/pc.
		M10x20	67060059	24	2307	2,17/pc.
		M10x35	67060077	24	2307	2,75/pc.
		M10x60	67060010	24	2307	4,12/pc.

## Ecrou hexagonal

	type	référence	page catal.	groupe d'articles	prix en €	
	Acier à zingage électrolytique	M8	67020095	24	2307	0,15/pc.
		M10	67020079	24	2307	0,17/pc.

## Ecrou hexagonal

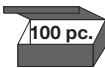
	type	référence	page catal.	groupe d'articles	prix en €	
	Acier à zingage électrolytique, bichromaté	M8	67020062	24	2307	0,15/pc.
		M10	67020014	24	2307	0,27/pc.

## Ecrou hexagonal

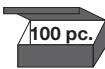
	type	référence	page catal.	groupe d'articles	prix en €	
	Acier galvanisé à chaud	M8	67030062	24	2307	0,21/pc.
		M10	67030014	24	2307	0,72/pc.

## Ecrou hexagonal

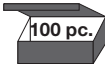
	type	référence	page catal.	groupe d'articles	prix en €	
	Acier inoxydable AISI 304	M8	67060062	24	2307	1,01/pc.
		M10	67060014	24	2307	2,32/pc.

## Rondelle

	type	référence	page catal.	groupe d'articles	prix en €	
	Acier à zingage électrolytique	M8	67020083	24	2307	0,08/pc.
		M10	67020061	24	2307	0,18/pc.

## Rondelle

	type	référence	page catal.	groupe d'articles	prix en €	
	Acier à zingage électrolytique, bichromaté	M8	67020063	24	2307	0,11/pc.
		M10	67020013	24	2307	0,18/pc.



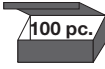



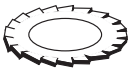

## Rondelle

	type	référence	page catal.	groupe d'articles	prix en €	
	Acier galvanisé à chaud	M8	67030063	24	2307	0,11/pc.
		M10	67030013	24	2307	0,28/pc.

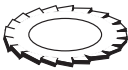
## Rondelle

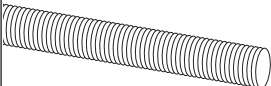
	type	référence	page catal.	groupe d'articles	prix en €	
	Acier inoxydable AISI 316	M8	67060063	24	2307	0,51/pc.
		M10	67060064	24	2307	0,75/pc.

# Systemes de suspension – treillis à câbles

	type	référence	page catal.	groupe d'articles	prix en €	
	<b>Rondelle étoilée</b>					
	Acier inoxydable	M8	67020084	2307	0,24/pc.	
	 100 pc.					
	<b>Rondelle étoilée</b>					
	Acier inoxydable	M10	67020086	2307	0,33/pc.	
	 100 pc.					
	<b>Tige filetée</b>					
	Acier à zingage électrolytique	M6	67020140	2307	4,45/pc.	
	bichromaté	M8	67020044	2307	4,90/pc.	
		 0,5 m				
	<b>Tige filetée</b>					
	Acier inoxydable AISI 316	M8	67060044	2307	26,59/pc.	
		 0,5 m				
	<b>Tige filetée</b>					
	Acier à zingage électrolytique, bichromaté	M6	67020141	14	2307	5,46/m
		M8	67020045	14	2307	5,63/m
	M10	67020145	14	2307	6,96/m	
	 1 m					
<b>Tige filetée</b>						
Acier inoxydable AISI 316	M6	67060141	14	2307	31,98/m	
	M8	67060045	14	2307	34,72/m	
	M10	67060145	14	2307	43,56/m	
	 1 m					

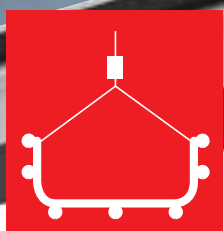

# spiderband®

## Système de suspension avec câble

Découvrez ici les atouts de **spiderband®**:

- ✓ un montage simple et rapide grâce au système flexible
- ✓ un éventail de possibilités de fixation
- ✓ un montage simple grâce au nombre limité d'articles
- ✓ une grande capacité de charge jusqu'à 120 kg.

**reji**band®  
CE **pemsa**









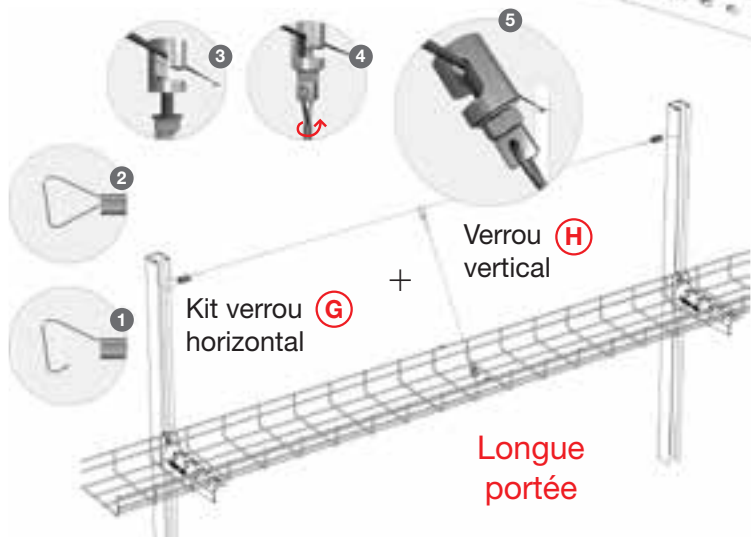
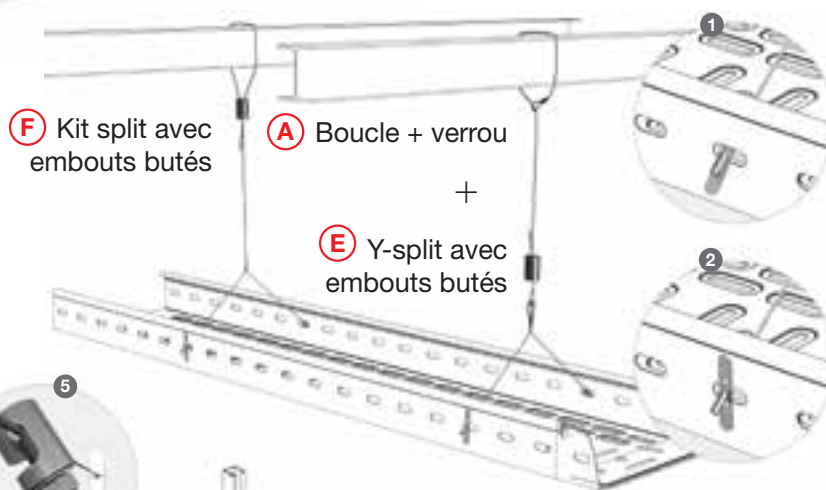
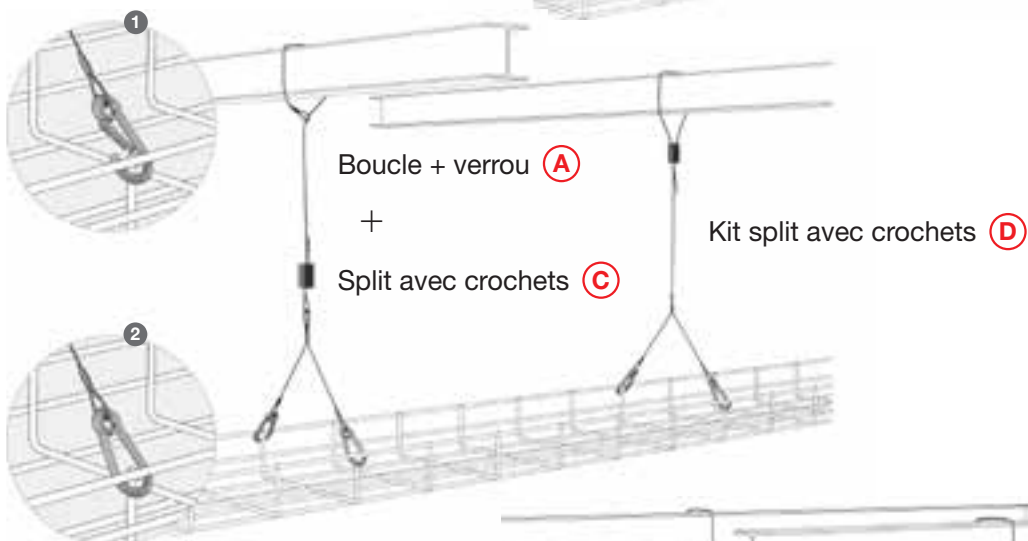
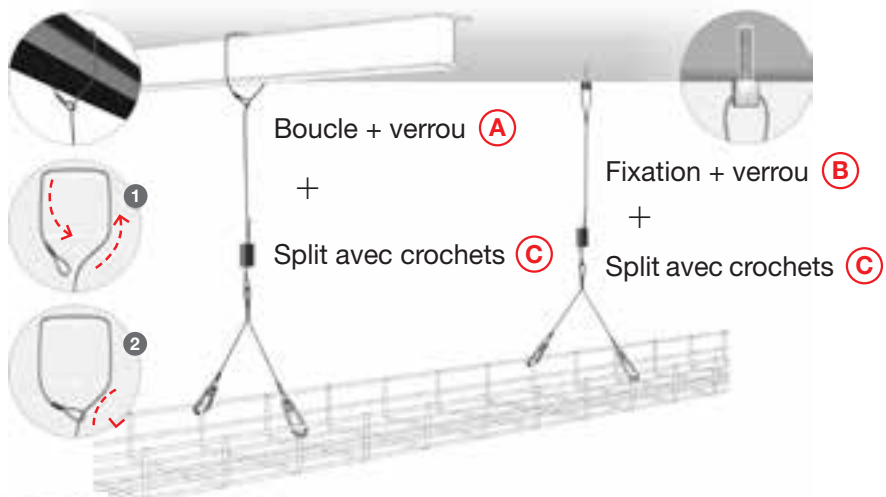

## Vue d'ensemble de l'installation

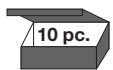



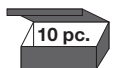
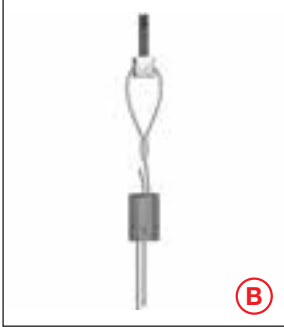

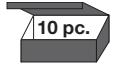

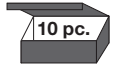

**spiderband®**



# Systeme de suspension avec cable SPIDERBAND

	type	référence	page catal.	groupe d'articles	prix en €
<b>Verrou</b>					
	Aluminium	10	62301100	1505	5,74/pc.
		50	62301400	1505	6,51/pc.
		120	62301800	1505	11,83/pc.
<b>Câble</b>					
	Acier à zingage électrolytique				
		10	62302102	1505	0,63/m
		50	62302401	1505	0,70/m
		120	62302801	1505	1,05/m
<b>Boucle + verrou</b>					
	Acier à zingage électrolytique				
		10/1	62303101	1505	9,17/pc.
		45/1	62303301	1505	11,13/pc.
		90/1	62303601	1505	26,11/pc.
		10/3	62303103	1505	11,69/pc.
		45/3	62303303	1505	14,07/pc.
		90/3	62303603	1505	29,40/pc.
		10/5	62303105	1505	14,21/pc.
		45/5	62303305	1505	16,94/pc.
90/5		62303605	1505	32,69/pc.	
<b>Fixation + verrou</b>					
	Acier à zingage électrolytique				
	10/M6x20/1	62304101	1505	9,38/pc.	
	45/M8x20/1	62304301	1505	11,41/pc.	
	90/M8x20/1	62304601	1505	12,88/pc.	
	10/M6x20/3	62304103	1505	11,90/pc.	
	45/M8x20/3	62304303	1505	14,35/pc.	
	90/M8x20/3	62304603	1505	16,24/pc.	
	10/M6x20/5	62304105	1505	19,81/pc.	
	45/M8x20/5	62304305	1505	17,29/pc.	
	90/M8x20/5	62304605	1505	28,14/pc.	
<b>Split avec crochets</b>					
	Acier à zingage électrolytique	50/300	62305430	1505	8,82/pc.
		50/460	62305440	1505	9,10/pc.
<b>Split avec crochets + verrou</b>					
	Acier à zingage électrolytique	35/300/1	62307231	1505	19,18/pc.
		90/300/1	62307631	1505	25,55/pc.
		35/300/3	62307233	1505	20,79/pc.
		90/300/3	62307633	1505	29,89/pc.
		35/460/1	62307241	1505	19,25/pc.
		90/460/1	62307641	1505	25,55/pc.
		35/460/3	62307243	1505	20,86/pc.
		90/460/3	62307643	1505	28,77/pc.

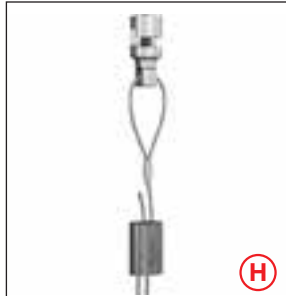
# Systeme de suspension avec cable SPIDERBAND

	type	référence	page catal.	groupe d'articles	prix en €
 <p>(E)</p>	<b>Y-split avec embouts butés</b>				
	Acier à zingage électrolytique	35/300	62306230	1505	7,98/pc.
		35/460	62306240	1505	8,26/pc.
		35/500	62306250	1505	8,47/pc.
					
 <p>(F)</p>	<b>Y-split avec embouts butés + verrou</b>				
	Acier à zingage électrolytique	35/300/1	62308231	1505	17,36/pc.
		90/300/1	62308631	1505	24,78/pc.
		35/300/3	62308233	1505	18,76/pc.
		90/300/3	62308633	1505	27,16/pc.
		35/460/1	62308241	1505	17,29/pc.
		90/460/1	62308641	1505	24,99/pc.
		35/460/3	62308243	1505	18,90/pc.
	90/460/3	62308643	1505	27,37/pc.	
					
 <p>(G)</p>	<b>Verrou + câble horizontal + verrou</b>				
	Acier à zingage électrolytique				
		75/5	62309501	1505	92,40/pc.
		75/10	62309502	1505	107,03/pc.
					
					
		75/15	62309503	1505	121,73/pc.
 <p>(H)</p>	<b>Crochet + câble vertical</b>				
	Acier à zingage électrolytique	35/1	62310201	1505	18,76/pc.
					



# Les profilés Stagobel

La gamme de profilés Stagobel est disponible dans **diverses longueurs, largeurs et finitions** : un profilé simple ou double, avec ou sans rebord dentelé, différents types de perforation, etc., .... et ce, en Sendzimir, en galvanisé à chaud ou en acier inoxydable.



**Les profilés Stagobel peuvent notamment être utilisés dans :**

- ✓ les constructions légères en acier
- ✓ la construction de machines
- ✓ les équipements techniques d'un bâtiment
- ✓ la suspension de systèmes de support de câbles (échelles à câbles, goulottes, chemins de câbles, etc.)
- ✓ les systèmes de ventilation et de gaines d'air, le HVAC
- ✓ les systèmes sanitaires.















	1	2	3	4	5	6	7	8
<b>Dimensions (mm)</b>	30x15	30x15	41x21	41x41	41x41	41x41	41x21 (double)	41x41 (double)
<b>Epaisseur (mm)</b>	2,0	1,5	2,0   2,5	2,0   2,5	2,5	2,5	2,0	2,5
<b>Longueur (mm)</b>	2000	4000	6000   3000   6000	6000   3000   6000	6000	6000	6000	6000
<b>Modèle de perforation (mm)</b>	30x11 + 5x5	30x14	30x14	30x14	40x13	/	30x14	30x14
<b>Rebord dentelé</b>			✓	✓			✓	✓
<b>G.S.</b>	✓	✓						
<b>H.D.</b>			✓	✓			✓	✓
<b>INOX 316</b>					✓	✓		

**G.S.** galvanisation Sendzimir NBN EN 10346 – recommandé dans les environnements corrosifs C2 (faible)  
**H.D.** galvanisation à chaud NBN EN ISO 1461 – recommandé dans les environnements corrosifs C3/C4 (moyen/haut)  
**INOX 316** acier inoxydable AISI 316 – recommandé dans les environnements corrosifs C5-M (très élevé/maritime)

 voir page 2













Profils

# Profilés

	type	référence	page catal.	groupe d'articles	prix en €	
	<b>Profilé 30-15-2.0 avec perforations 30x11 + 5x5</b>					
	Acier galvanisé Sendzimir					
	2000	PROF30-15-2.0-2/GS		1501	6,16/m	
	<b>Profilé 30-15-1.5 avec perforations 30x14</b>					
	Acier galvanisé Sendzimir					
	4000	PROF30-15-1.5-4/GS		1501	4,91/m	
	<b>Profilé 41-21-2.0 avec perforations 30x14</b>					
	Acier galvanisé à chaud					
	6000	PROF41-21-2.0-6/HD		1501	11,73/m	
	<b>Profilé 41-21-2.5 avec perforations 30x14</b>					
	Acier galvanisé à chaud					
		3000	PROF41-21-2.5-3/HD		1501	16,56/m
		6000	PROF41-21-2.5-6/HD		1501	16,56/m
	<b>Profilé 41-41-2.0 avec perforations 30x14</b>					
	Acier galvanisé à chaud					
	6000	PROF41-41-2.0-6/HD		1501	20,13/m	
	<b>Profilé 41-41-2.5 avec perforations 30x14</b>					
	Acier galvanisé à chaud					
		3000	PROF41-41-2.5-3/HD		1501	22,88/m
	6000	PROF41-41-2.5-6/HD		1501	22,88/m	



# Profilés







	type	référence	page catal.	groupe d'articles	prix en €
	<b>Profilé 41-41-2.5 avec perforations 40x13</b>				
	Acier inoxydable AISI 316				
	6000	PROF41-41-2.5-6/RVS316P	1501	101,19/m	
	<b>Profilé 41-41-2.5 sans perforations</b>				
	Acier inoxydable AISI 316				
	6000	PROF41-41-2.5-6/RVS316	1501	96,82/m	
	<b>Profilé double 41-21-2.0, hauteur = 42 mm, avec perforations 30x14</b>				
	Acier galvanisé à chaud				
	6000	PROFD41-21-2.0-6/HD	1501	30,04/m	
	<b>Profilé double 41-41-2.5, hauteur = 82 mm, avec perforations 30x14</b>				
	Acier galvanisé à chaud				
	6000	PROFD41-41-2.5-6/HD	1501	50,34/m	
	<b>Bouchon pour profilé épaisseur 2,5 mm et hauteur 21 mm</b>				
	Matière synthétique, vert foncé				
	21	KOKSPLDB	1503	1,77/pc.	
	<b>Bouchon pour profilé épaisseur 2,5 mm et hauteur 41 mm</b>				
	Matière synthétique, vert foncé				
	41	KOKSPSDB	1503	2,75/pc.	

# Profilés

	type	référence	page catal.	groupe d'articles	prix en €
	<b>Raccord droit 40x6x184</b>				
Acier galvanisé à chaud	N1	67030205		1503	5,10/pc.
	<b>Raccord droit renforcé 49x56x181</b>				
Acier galvanisé à chaud	N2	67030214		1503	16,60/pc.
	<b>Equerre 90° 50x50x40</b>				
Acier galvanisé à chaud	N3	67030201		1503	2,33/pc.
	<b>Equerre 90° 95x95x40</b>				
Acier galvanisé à chaud	N4	67030202		1503	4,66/pc.
	<b>Equerre 135° 75x105x39</b>				
Acier galvanisé à chaud	N5	67030210		1503	4,00/pc.
	<b>Equerre 45° 66x63x39</b>				
Acier galvanisé à chaud	N6	67030209		1503	4,00/pc.
	<b>Raccord en L 88x6x88</b>				
Acier galvanisé à chaud	N7	67030211		1503	5,39/pc.















# Profilés

	type	référence	page catal.	groupe d'articles	prix en €
	<b>Raccord en T 90° 105x51x90</b>				
	Acier galvanisé à chaud	N8	67030204	1503	10,19/pc.
	<b>Raccord en T 90x6x140</b>				
	Acier galvanisé à chaud	N9	67030203	1503	13,32/pc.
	<b>Raccord trois directions 114x6x114</b>				
	Acier galvanisé à chaud	N10	67030212	1503	6,48/pc.
	<b>Equerre 90° renforcée 101x101x48</b>				
	Acier galvanisé à chaud	N11	67030213	1503	14,34/pc.
	<b>Etrier Oméga (40x47x142)</b>				
	Acier galvanisé à chaud	N12	67030207	1503	14,34/pc.
	<b>Etrier Oméga (40x87x141)</b>				
	Acier galvanisé à chaud	N13	67030208	1503	6,19/pc.
	<b>Etrier Oméga (40x27x142)</b>				
	Acier galvanisé à chaud	N14	67030206	1503	6,84/pc.

# Profilés

	type	référence	page catal.	groupe d'articles	prix en €
	<b>Equerre 90° double 50x90x90</b>				
	Acier galvanisé à chaud	N15 67030215		1503	5,61/pc.
	<b>Equerre 90° triple 50x90x90</b>				
	Acier galvanisé à chaud	N16 67030216		1503	11,87/pc.
	<b>Support profilé 41x41 (106x150x150)</b>				
	Acier galvanisé à chaud	67030064		1503	30,43/pc.
	<b>Support profilé 41x82 (94x150x150)</b>				
	Acier galvanisé à chaud	67030164		1503	28,10/pc.
	<b>Articulation réglable 154x135x77</b>				
	Acier galvanisé à chaud	67030102		1503	26,06/pc.
	<b>Etrier pour profilé / poutre en I (95x70x80)</b>				
	Acier galvanisé à chaud	67030101		1503	13,76/pc.
	<b>Accouplement treillis / profilé</b>				
	Acier galvanisé à chaud	67030049		2307	2,39/pc.
	 50 pc.				

	type	référence	page catal.	groupe d'articles	prix en €	
	<b>Ecrou coulissant</b>					
		Acier à zingage électrolytique	M6	67020055	1503	0,62/pc.
			M8	67010056	1503	0,94/pc.
			M10	67011058	1503	1,35/pc.
	<b>Ecrou coulissant</b>					
		Acier galvanisé à chaud	M6	67031054	1503	1,04/pc.
			M8	67030056	1503	1,25/pc.
			M10	67031058	1503	1,56/pc.
	<b>Ecrou coulissant</b>					
		Acier inoxydable AISI 316	M6	67061054	1503	6,55/pc.
		M8	67060056	1503	6,97/pc.	
		M10	67060058	1503	7,70/pc.	
	<b>Ecrou coulissant avec ressort</b>					
		Acier à zingage électrolytique	M6 / 21	67620058	1503	1,35/pc.
			M6 / 41	67620158	1503	1,51/pc.
			M8 / 21	67820058	1503	1,46/pc.
			M8 / 41	67820158	1503	1,61/pc.
			M10 / 21	67020058	1503	1,66/pc.
			M10 / 41	67020158	1503	1,87/pc.
	<b>Ecrou coulissant avec ressort</b>					
		Acier galvanisé à chaud	M6 / 21	67630058	1503	1,46/pc.
			M6 / 41	67630158	1503	1,56/pc.
		M8 / 21	67830058	1503	1,66/pc.	
		M8 / 41	67830158	1503	1,72/pc.	
		M10 / 21	67030058	1503	1,82/pc.	
		M10 / 41	67030158	1503	1,92/pc.	
	<b>Boulon coulissant à ressort</b>					
	Acier à zingage électrolytique	M10x30	67020159	1503	2,87/pc.	
	<b>Boulon hexagonal</b>					
		Acier à zingage électrolytique	M8X35	67010066	2307	0,62/pc.
			M8X35	67020077	2307	1,00/pc.
	<b>Boulon hexagonal</b>					
		Acier galvanisé à chaud	M8X35	67030066	2307	0,80/pc.
			M10X35	67030077	2307	1,52/pc.
	<b>Boulon hexagonal</b>					
		Acier inoxydable AISI 316L	M8X35	67060066	2307	1,72/pc.
			M10X35	67060077	2307	2,75/pc.







# Systemes de support de câbles avec maintien de fonction

## Objectif

Les systemes de support de câbles avec maintien de fonction sont essentiels pour une infrastructure à l'épreuve du feu. Les systemes de sécurité tels qu'un éclairage de secours, un systeme d'alarme incendie, ... doivent, en cas d'incendie, continuer à fonctionner parfaitement pendant une durée déterminée. Il est dès lors crucial qu'outre le câblage, les systemes de support de câbles (échelle à câbles, chemin de câbles et treillis à câbles) aient aussi ces propriétés ignifuges et garantissent donc, en cas d'incendie, la fonctionnalité et la fiabilité de l'installation durant cette période.

## Application

Les systemes de support de câbles avec maintien de fonction sont notamment appliqués pour des installations d'évacuation des fumées, de ventilation, d'alarme et de sécurité dans les bâtiments publics, les immeubles de bureaux, les tunnels, les hôpitaux, ...



Echelles à câbles KHZPS – p. 114-115



Treillis à câbles Rejistaband – p. 116-118  
Chemins de câbles Pemsaband – p. 119-121



Boîte de connexion E90 – p. 123

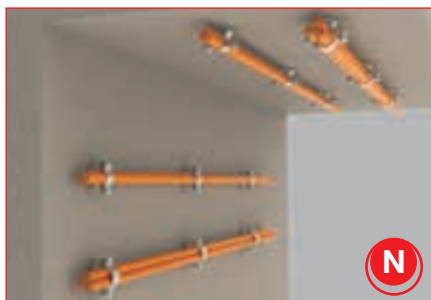

Attache OMEGA E90 – p. 122





Etrier de câbles E90 – p. 122



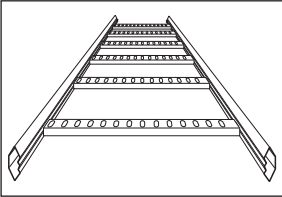
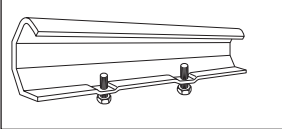
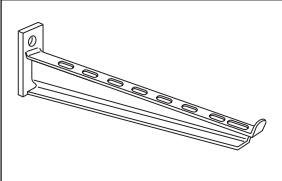

Attache câbles E90 – p. 122

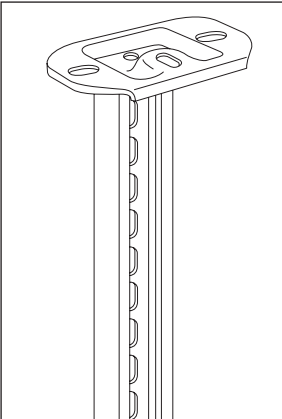
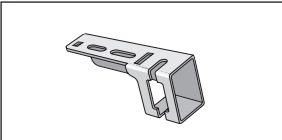
# Maintien de fonction – échelles à câbles

	type	référence	page catal.	groupe d'articles	prix en €	
	<b>Echelle à câbles KHZPS</b>					
	Acier galvanisé Sendzimir	150	725350	23	1308	38,22/m
		200	725351	23	1308	38,22/m
		300	725352	23	1308	39,53/m
		400	725353	23	1308	41,18/m
	<b>Accouplement 21</b>					
Zinc+	21	795051	78	1313	13,33/pc.	
	<b>Console 50</b>					
Acier galvanisé à chaud	50/ 150	723433	32	1304	13,48/pc.	
	50/ 200	723434	32	1304	13,83/pc.	
	50/ 300	723436	32	1304	15,92/pc.	
	50/ 400	723437	32	1304	25,16/pc.	
	<b>Etrier 42</b>					
	Acier galvanisé Sendzimir	42	795239	34	1313	5,08/pc.
	<b>Pendard simple 2F</b>					
	Acier galvanisé à chaud	2F/ 280	717196	46	1313	21,09/pc.
		2F/ 370	717197	46	1313	24,10/pc.
		2F/ 505	717198	46	1313	27,36/pc.
		2F/ 640	794202		1313	28,33/pc.
		2F/ 730	717199	46	1313	31,40/pc.
	<b>Fixation tige/console 82</b>					
	Acier galvanisé à chaud	82	786768	36	1313	63,65/pc.

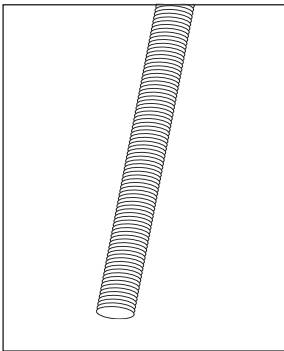

# Maintien de fonction – échelles à câbles

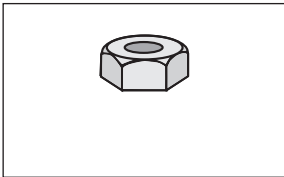
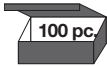
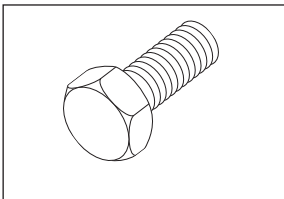
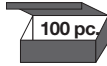
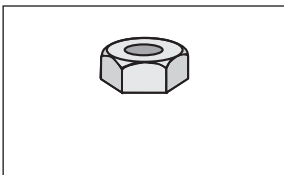
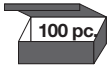





	type	référence	page catal.	groupe d'articles	prix en €
	<b>Tige filetée M10</b>				
	Acier à zingage électrolytique	2000	716792	42	1313
					
	<b>Ecrou hexagonal</b>				
	Acier galvanisé à chaud	M10	723938	42	1313
					
	<b>Boulon hexagonal M8 x 50</b>				
	Acier à zingage électrolytique	M8x50	795132		1313
					
	<b>Ecrou hexagonal</b>				
	Acier à zingage électrolytique	M8	794715		1313
					

# Maintien de fonction – treillis à câbles



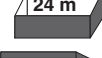





## Treillis à câbles Rejiband 60

Acier à zingage électrolytique,  
bichromaté

type	référence	page catal.	groupe d'articles	prix en €	
	 60 x 100	60222100	4	2301	11,61/m
	 60 x 150	60222150	4	2301	14,35/m
	 60 x 200	60222200	4	2301	16,28/m
	 60 x 300	60222300	4	2301	21,11/m
	 60 x 400	60222400	4	2301	30,33/m

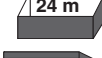
## Treillis à câbles Rejiband 60

Acier galvanisé à chaud

	 60 x 100	60232100	4	2305	16,23/m
	 60 x 150	60232150	4	2305	20,09/m
	 60 x 200	60232200	4	2305	23,78/m
	 60 x 300	60232300	4	2305	32,52/m
	 60 x 400	60232400	4	2305	42,95/m



## Accouplement renforcé 61

Acier à zingage électrolytique,  
bichromaté

	64020061	4	2307	1,46/pc.
---	----------	---	------	----------

## Accouplement renforcé 61

Acier galvanisé à chaud

	64030061	4	2307	2,06/pc.
---	----------	---	------	----------

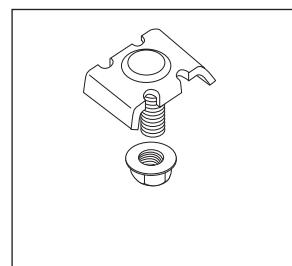

## Accouplement 60

Acier à zingage électrolytique,  
bichromaté

	64020060	4	2307	1,07/pc.
---	----------	---	------	----------

## Accouplement 60









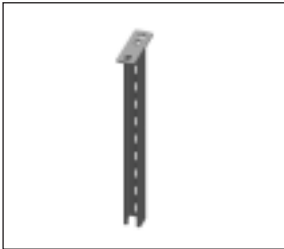

Acier galvanisé à chaud

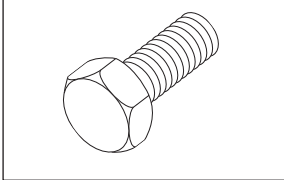
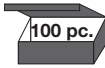
	64030060	4	2307	1,61/pc.
---	----------	---	------	----------

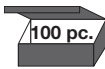



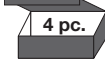

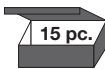

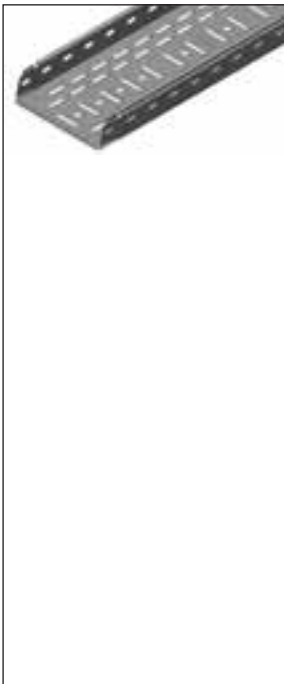

# Maintien de fonction – treillis à câbles

	type	référence	page catal.	groupe d'articles	prix en €	
	<b>SPLUS console Oméga Click</b>					
	Acier galvanisé Sendzimir	100	62021104	4	2307	5,90/pc.
		150	62021154	4	2307	7,63/pc.
		200	62021204	4	2307	8,74/pc.
		300	62021304	4	2307	10,30/pc.
400		62021404	4	2307	15,41/pc.	
	<b>SPLUS console Oméga Click</b>					
	Acier galvanisé à chaud	100	62031104	4	2307	9,03/pc.
		150	62031154	4	2307	11,55/pc.
		200	62031204	4	2307	12,38/pc.
		300	62031304	4	2307	13,24/pc.
400		62031404	4	2307	20,44/pc.	
	<b>SPLUS étrier en C Oméga Click</b>					
	Acier galvanisé Sendzimir	100	62022104	8	2307	11,65/pc.
		150	62022154	8	2307	12,24/pc.
		200	62022204	8	2307	13,16/pc.
		300	62022304	8	2307	15,41/pc.
400		62022404	8	2307	22,73/pc.	
	<b>SPLUS étrier en C Oméga Click</b>					
	Acier galvanisé à chaud	100	62032104	8	2307	15,41/pc.
		150	62032154	8	2307	16,94/pc.
		200	62032204	8	2307	18,91/pc.
		300	62032304	8	2307	22,66/pc.
400		62032404	8	2307	34,65/pc.	
	<b>SPLUS connecteur Oméga E90</b>					
	Acier galvanisé à chaud		62031090	4	2307	5,83/pc.
	<b>E90 accouplement 60</b>					
	Acier galvanisé à chaud	M6x30	64030160	4	2307	1,97/pc.
	<b>Tige filetée</b>					
	Acier à zingage électrolytique, bichromaté	M8/0,5m	67020044	4	2307	4,90/pc.
		M8/1m	67020045	4	2307	5,63/m
		M10/1m	67020145	4	2307	6,96/m
						
	<b>Ecrou hexagonal</b>					
	Acier à zingage électrolytique, bichromaté	M8	67020062	4	2307	0,15/pc.
		M10	67020014	4	2307	0,27/pc.
						

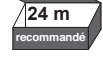

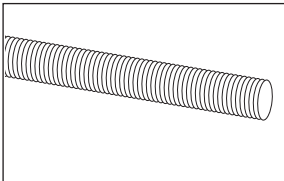
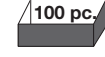
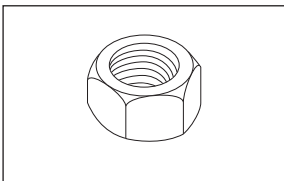
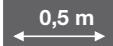



# Maintien de fonction – treillis à câbles

	type	référence	page catal.	groupe d'articles	prix en €		
	<b>Pendant simple</b>						
	Acier galvanisé à chaud	500 1000	67030660 67030661	10 10	2307 2307	40,05/pc. 60,42/pc.	
	<b>Pendant double</b>						
	Acier galvanisé à chaud	500 1000	67030662 67030663	10 10	2307 2307	77,02/pc. 135,00/pc.	
	<b>Boulon hexagonal</b>						
	Acier à zingage électrolytique Acier galvanisé à chaud	M10x35 M10x35	67020077 67030077	10 10	2307 2307	1,00/pc. 1,52/pc.	
							
	<b>Ecroû coulissant avec ressort</b>						
	Acier à zingage électrolytique Acier galvanisé à chaud	M10/41 M10/41	67020158 67030158	10 10	1503 1503	1,87/pc. 1,92/pc.	
							
	<b>RPLUS console Click</b>						
	Acier galvanisé Sendzimir	100 150 200 300 400	62025103 62025153 62025203 62025303 62025403	6 6 6 6 6	2307 2307 2307 2307 2307	7,37/pc. 8,60/pc. 9,89/pc. 11,33/pc. 16,36/pc.	
							
		<b>RPLUS console Click</b>					
		Acier galvanisé à chaud	100 150 200 300 400	62035103 62035153 62035203 62035303 62035403	6 6 6 6 6	2307 2307 2307 2307 2307	11,39/pc. 12,73/pc. 15,04/pc. 18,62/pc. 20,82/pc.
							
		<b>RPLUS connecteur E90</b>					
		Acier galvanisé à chaud		62035001	6	2307	5,83/pc.
							

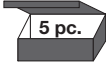
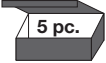
# Maintien de fonction – chemins de câbles

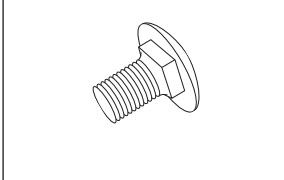
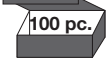
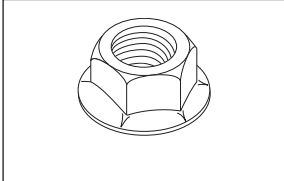
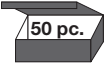



	type	référence	page catal.	groupe d'articles	prix en €	
	<b>Chemin de câbles Pemsaband SX Click, H = 60 mm</b>					
	Acier galvanisé Sendzimir					
			60x100	75522100	12 2308	9,53/m
			60x150	75522150	12 2308	12,73/m
			60x200	75522200	12 2308	13,80/m
			60x300	75522300	12 2308	18,37/m
			60x400	75522400	12 2308	26,53/m
	<b>Chemin de câbles Pemsaband SX Click, H = 60 mm</b>					
	Acier galvanisé à chaud					
			60x100	75232100	12 2308	24,88/m
		60x150	75232150	12 2308	29,38/m	
		60x200	75232200	12 2308	35,32/m	
		60x300	75232300	12 2308	44,96/m	
		60x400	75232400	12 2308	58,08/m	
	<b>Boulon à collet carré et écrou 6 pans à embase crénelée</b>					
	Acier à zingage électrolytique	M6x12	67010093	2309	0,33/pc.	
						
	<b>Boulon à collet carré et écrou 6 pans à embase crénelée</b>					
	Acier galvanisé à chaud	M6x12	67030093	2309	0,46/pc.	
						
	<b>Tige filetée</b>					
	Acier à zingage électrolytique, bichromaté	M8/0,5m	67020044	12 2307	4,90/pc.	
		M8/1m	67020045	12 2307	5,63/m	
		M10/1m	67020145	12 2307	6,96/m	
						
	<b>Écrou hexagonal</b>					
	Acier à zingage électrolytique, bichromaté	M8	67020062	12 2307	0,15/pc.	
		M10	67020014	12 2307	0,27/pc.	
						

# Maintien de fonction – chemins de câbles





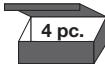

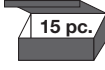

	type	référence	page catal.	groupe d'articles	prix en €	
	<b>SPLUS console Oméga Click</b>					
	Acier galvanisé Sendzimir	100	62021104	12	2307	5,90/pc.
		150	62021154	12	2307	7,63/pc.
		200	62021204	12	2307	8,74/pc.
		300	62021304	12	2307	10,30/pc.
		400	62021404	12	2307	15,41/pc.
<b>SPLUS console Oméga Click</b>						
Acier galvanisé à chaud	100	62031104	12	2307	9,03/pc.	
	150	62031154	12	2307	11,55/pc.	
	200	62031204	12	2307	12,38/pc.	
	300	62031304	12	2307	13,24/pc.	
	400	62031404	12	2307	20,44/pc.	
		<b>SPLUS connecteur Oméga E90</b>				
Acier galvanisé à chaud			62031090	12	2307	5,83/pc.
						
	<b>Boulon à collet carré</b>					
	Acier galvanisé à chaud	M6x30	67030109	12	2309	0,41/pc.
						
	<b>Ecrou 6 pans à embase crénelée</b>					
	Acier galvanisé à chaud	M6	64030059	12	2309	0,23/pc.
						
	<b>SPLUS profilé support Click</b>					
	Acier galvanisé Sendzimir	100	63022104	16	2307	4,00/pc.
		150	63022154	16	2307	4,41/pc.
		200	63022204	16	2307	5,53/pc.
		300	63022304	16	2307	6,51/pc.
		400	63022404	16	2307	8,80/pc.
<b>SPLUS profilé support Click</b>						
Acier galvanisé à chaud	100	63032104	16	2307	6,64/pc.	
	150	63032154	16	2307	7,10/pc.	
	200	63032204	16	2307	8,69/pc.	
	300	63032304	16	2307	10,42/pc.	
	400	63032404	16	2307	12,65/pc.	



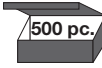

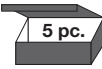

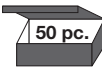
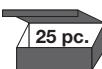
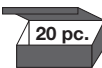
# Maintien de fonction – chemins de câbles

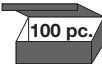
	type	référence	page catal.	groupe d'articles	prix en €	
	<b>Pendant simple</b>					
	Acier galvanisé à chaud	500 1000	67030660 67030661	18 18	2307 2307	40,05/pc. 60,42/pc.
	<b>Pendant double</b>					
	Acier galvanisé à chaud	500 1000	67030662 67030663	18 18	2307 2307	77,02/pc. 135,00/pc.
	<b>RPLUS console Click</b>					
	Acier galvanisé Sendzimir	100 150 200 300 400	62025103 62025153 62025203 62025303 62025403	18 18 18 18 18	2307 2307 2307 2307 2307	7,37/pc. 8,60/pc. 9,89/pc. 11,33/pc. 16,36/pc.
						
	<b>RPLUS console Click</b>					
	Acier galvanisé à chaud	100 150 200 300 400	62035103 62035153 62035203 62035303 62035403	18 18 18 18 18	2307 2307 2307 2307 2307	11,39/pc. 12,73/pc. 15,04/pc. 18,62/pc. 20,82/pc.
						
	<b>RPLUS connecteur E90</b>					
	Acier galvanisé à chaud		62035001	18	2307	5,83/pc.
						

# Maintien de fonction

	type	référence	page catal.	groupe d'articles	prix en €	
<b>Attache pour câble simple</b>						
	Acier galvanisé Sendzimir	diam. câble				
	 = 1 bt.	simple	6 mm	K6708PO	2508	193,73/bt.
		simple	8 mm	K6710PO	2508	202,95/bt.
		simple	10 mm	K6712PO	2508	212,18/bt.
	 = 1 bt.	simple	14 mm	K6716EPO	2508	385,14/bt.
 = 1 bt.	double	14 mm	K6716EDPO	2508	319,19/bt.	
<b>Etrier pour groupe de câbles</b>						
	Acier galvanisé Sendzimir		KSD2S	2508	1,90/pc.	
	 = 1 bt.					
<b>Attache Oméga pour plusieurs câbles</b>						
	Acier galvanisé à chaud	diam. câble				
	 = 1 bt.		12-14 mm	K5216EZNF	2508	169,05/bt.
			14-18 mm	K5220ZNF	2508	187,73/bt.
			18-22 mm	K5225ZNF	2508	205,95/bt.
	 = 1 bt.		22-30 mm	K5232ZNF	2508	112,69/bt.
	 = 1 bt.		30-38 mm	K5240ZNF	2508	103,32/bt.
			38-50 mm	K5250ZNF	2508	117,43/bt.
		51-60 mm	K5263ZNF	2508	217,89/bt.	
<b>Vis à béton 6,3X35</b>						
	 = 1 sac	6,3x35	KSB6.3X35POGMT	2508	62,73/sac	

# Maintien de fonction

	type	référence	page catal.	groupe d'articles	prix en €
	<b>E90 Boîte de connexion IP54 pour câbles d'alimentation, avec bornier simple</b>				
	Matière synthétique exempte d'halogènes	1,5-6 mm <sup>2</sup>	K8135PO	2508	45,20/pc.
	<b>E90 Boîte de connexion IP66 pour câbles d'alimentation, avec bornier simple</b>				
	Matière synthétique exempte d'halogènes	1,5-6 mm <sup>2</sup>	KKSK100PO	2508	66,42/pc.
		1,5-10 mm <sup>2</sup>	KKSK125PO10	2508	80,26/pc.
		1,5-16 mm <sup>2</sup>	KKSK175PO16	2508	115,31/pc.
	<b>E90 Boîte de connexion IP66 pour câbles d'alimentation, avec bornier double</b>				
	Matière synthétique exempte d'halogènes	1,5-6 mm <sup>2</sup>	KKSK1252PO6	2508	89,94/pc.
		1,5-6 mm <sup>2</sup>	KKSK1752PO10	2508	115,31/pc.
	<b>E90 Boîte de connexion IP66 pour câbles d'alimentation, avec bornier simple et fusible</b>				
	Matière synthétique exempte d'halogènes	1,5-6 mm <sup>2</sup>	KKSK125PO6P	2508	92,25/pc.
		1,5-10 mm <sup>2</sup>	KKSK175PO10P	2508	119,93/pc.
	<b>E90 Boîte de connexion IP66 pour câbles de données, avec bornier</b>				
	Matière synthétique exempte d'halogènes	0,5-4 mm <sup>2</sup>	KKSK125DPO	2508	80,26/pc.
		0,5-4 mm <sup>2</sup>	KKSK175DPO	2508	129,15/pc.



Canal de sol ouvert pour charges lourdes

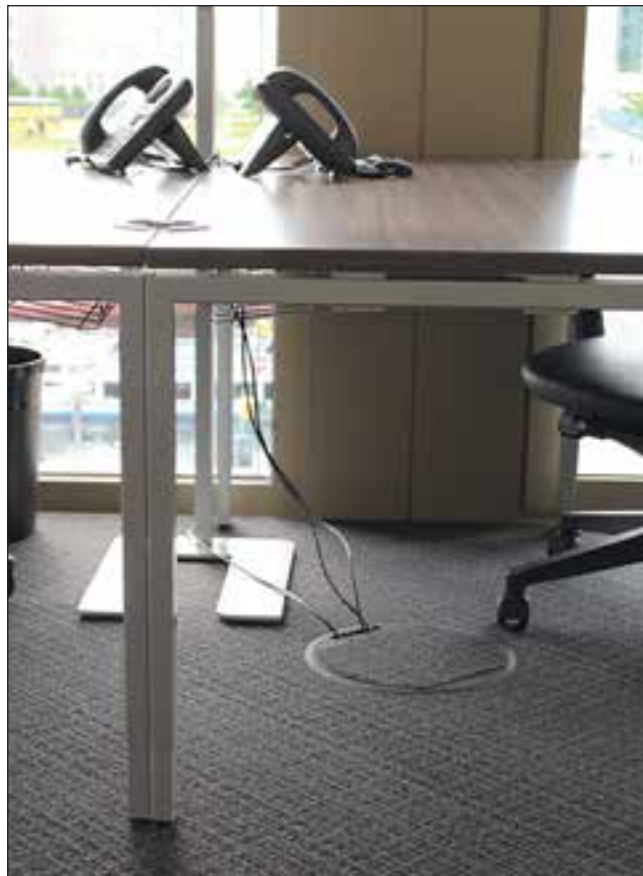

Gaine de sol noyée – boîte de sol en polyamide



Gaine de sol noyée – boîte de sol en acier inoxydable



Gaine de sol noyée – boîte de sol en acier inoxydable



Boîte de sol BODO



Boîte de sol en acier inoxydable





# Systemes de gaines de sol

## Systemes de canal de sol au ras du sol



Canal de sol ouvert pour bureaux page 128-129



Canal de sol ouvert pour charges lourdes page 130-131

## Systemes de gaines de sol noyees



Gainne de sol noyee fermee Voir tableau de selection aux pages suivantes



Canal de sol noyee avec couvercle page 135-136

# SYSTÈMES DE GAINES DE SOL NOYÉES POUR SOLS EN TAPIS BOÎTES DE SOL EN POLYAMIDE

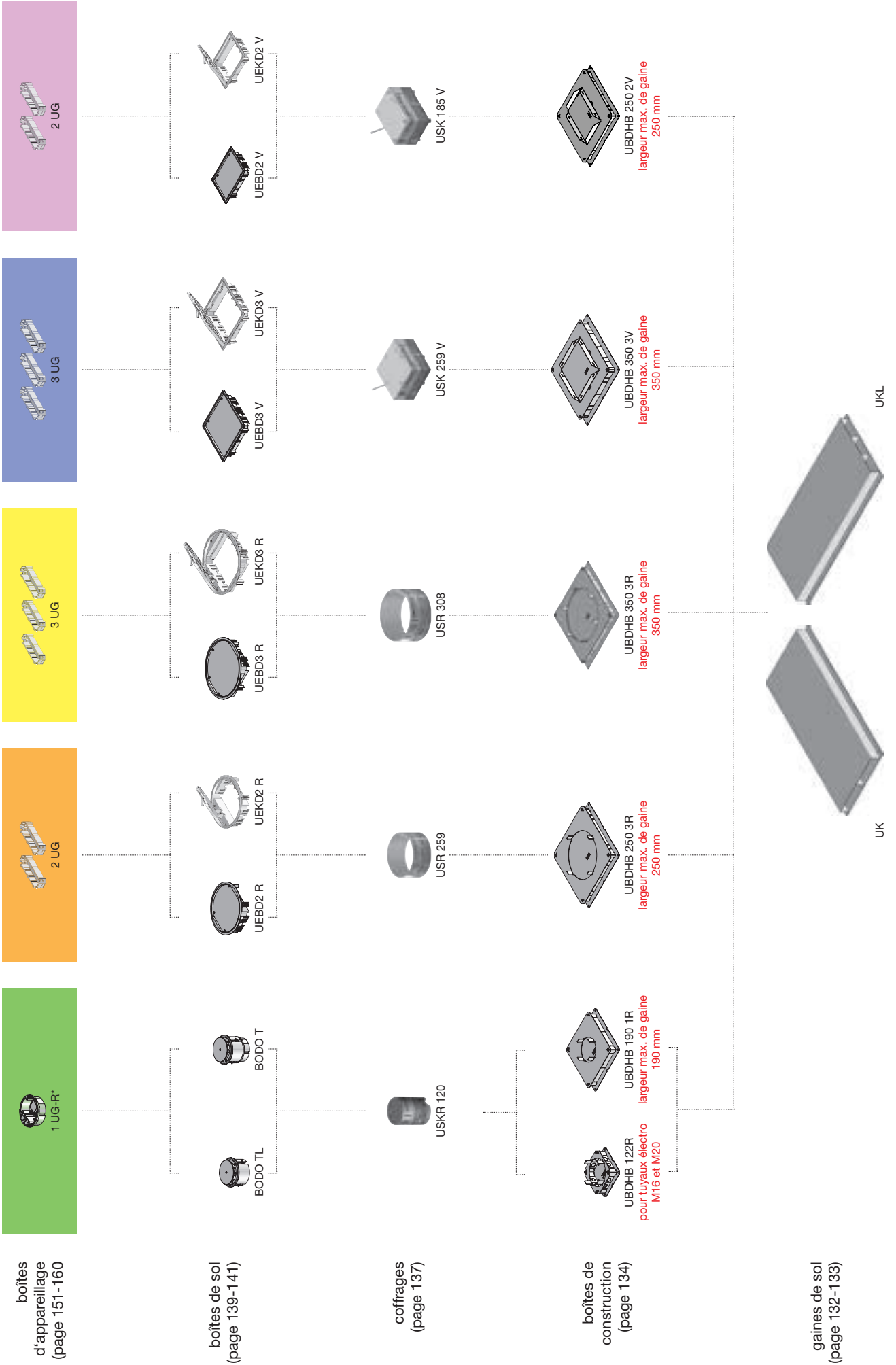



# SYSTÈMES DE GAINES DE SOL NOYÉES POUR PARQUET ET CARRELAGE - BOÎTES DE SOL EN ACIER INOXYDABLE

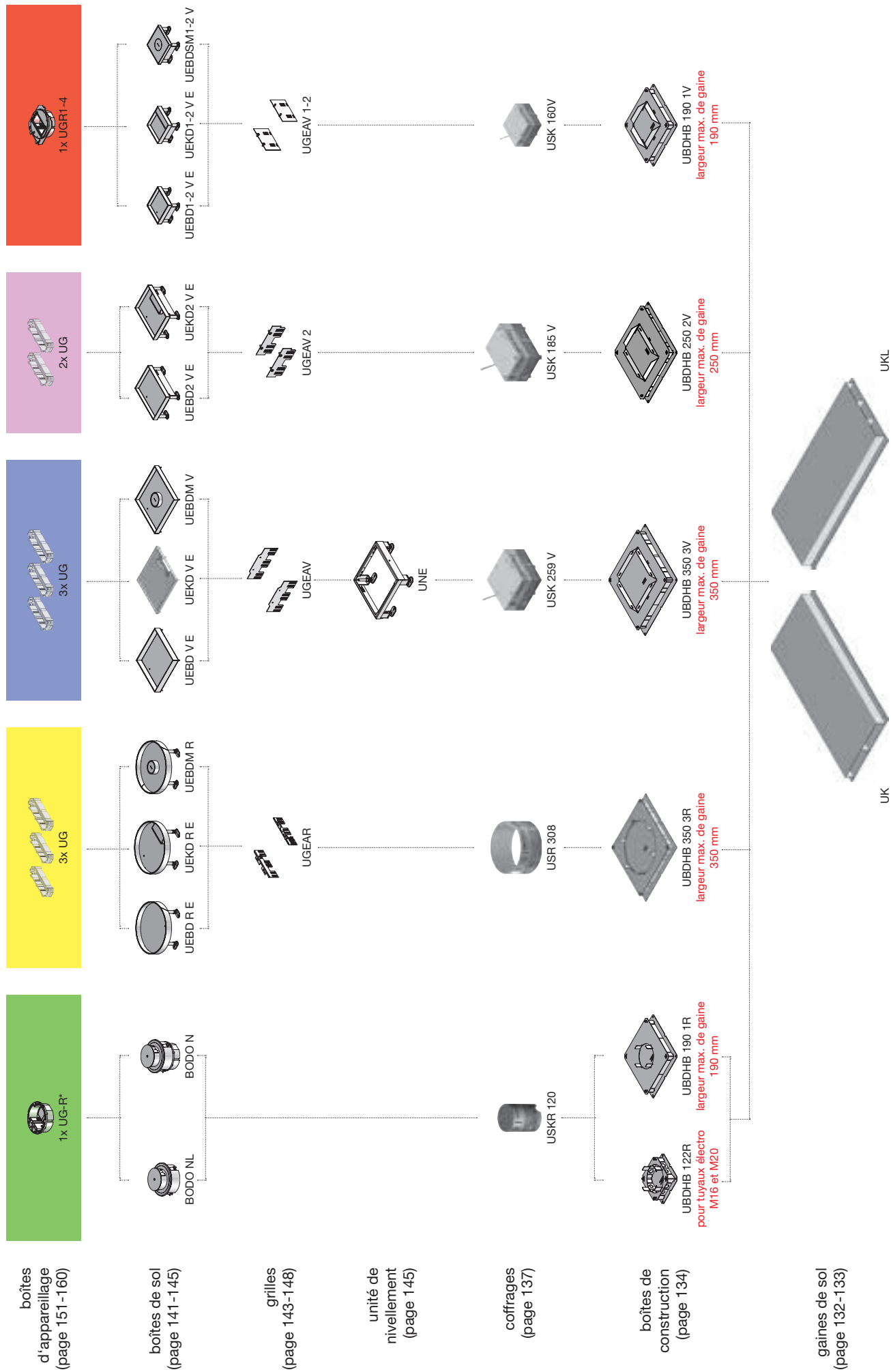



Systemes de  
gaines de sol

# Canaux de sol au ras du sol

	type	référence	page catal.	groupe d'articles	prix en €
<b>Système de gaines de sol ouvert</b>					
	Acier galvanisé Sendzimir				
		200	UEBS 20S	1407	157,61/m
		300	UEBS 30S	1407	173,67/m
		400	UEBS 40S	1407	189,73/m
<b>Paroi latérale</b>					
	Acier galvanisé Sendzimir				
		48-68	UEBSMSP 60S	1407	17,25/m
		88-108	UEBSMSP 100S	1407	21,41/m
<b>Paroi latérale</b>					
	Polyamide				
		48-68	UEBSMSP 60	1407	20,22/m
		88-108	UEBSMSP 100	1407	33,30/m
<b>Bac de fond</b>					
	Acier galvanisé Sendzimir				
		60-200	UEBSMSW 60-20S	1407	24,98/m
		60-300	UEBSMSW 60-30S	1407	29,14/m
		60-400	UEBSMSW 60-40S	1407	33,90/m
		80-200	UEBSMSW 80-20S	1407	26,76/m
		80-300	UEBSMSW 80-30S	1407	31,52/m
		80-400	UEBSMSW 80-40S	1407	36,88/m
		100-200	UEBSMSW 100-20S	1407	29,14/m
		100-300	UEBSMSW 100-30S	1407	33,90/m
		100-400	UEBSMSW 100-40S	1407	41,04/m
		120-200	UEBSMSW 120-20S	1407	31,52/m
		120-300	UEBSMSW 120-30S	1407	33,90/m
	120-400	UEBSMSW 120-40S	1407	41,04/m	
<b>Pied de nivellement</b>					
	Acier galvanisé Sendzimir				
		60/110	UEBSST 80S	1407	13,09/pc.
		100/150	UEBSST 150S	1407	17,85/pc.
<b>Embout</b>					
	Acier galvanisé Sendzimir				
		60-200	UEBSES 60-20S	1407	24,98/pc.
		60-300	UEBSES 60-30S	1407	27,36/pc.
		60-400	UEBSES 60-40S	1407	29,74/pc.
		100-200	UEBSES 100-20S	1407	26,17/pc.
		100-300	UEBSES 100-30S	1407	28,55/pc.
	100-400	UEBSES 100-40S	1407	30,92/pc.	

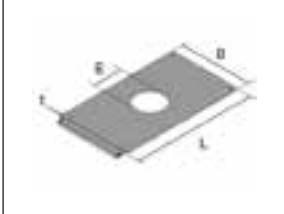
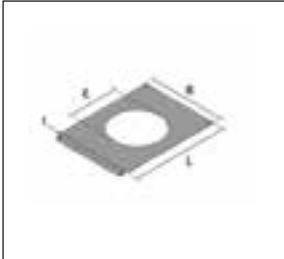
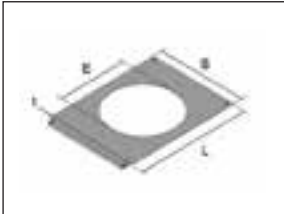
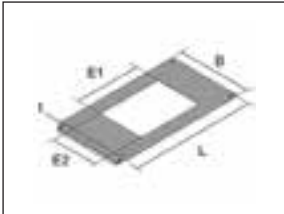
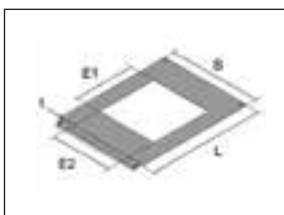

# Canaux de sol au ras du sol

	type	référence	page catal.	groupe d'articles	prix en €
<b>Dérivation</b>					
	Acier galvanisé Sendzimir				
	200	UEBSMA 20S		1407	31,64/pc.
	300	UEBSMA 30S		1407	32,24/pc.
	400	UEBSMA 40S		1407	32,83/pc.
<b>Pièce d'angle</b>					
	Acier galvanisé Sendzimir				
	200	UEBSMB 20S		1407	31,64/pc.
	300	UEBSMB 30S		1407	32,24/pc.
	400	UEBSMB 40S		1407	32,83/pc.
<b>Couvercle de montage, trou diamètre 122</b>					
	Acier galvanisé Sendzimir				
	200	UEBSMD-122R 20S		1407	53,53/pc.
	300	UEBSMD-122R 30S		1407	59,48/pc.
	400	UEBSMD-122R 40S		1407	65,43/pc.
<b>Couvercle de montage, trou diamètre 260</b>					
	Acier galvanisé Sendzimir				
	400	UEBSMD-260R 40S		1407	65,43/pc.
<b>Couvercle de montage, trou diamètre 307</b>					
	Acier galvanisé Sendzimir				
	400	UEBSMD-307R 40S		1407	65,43/pc.
<b>Couvercle de montage, trou 185 x 260</b>					
	Acier galvanisé Sendzimir				
	300	UEBSMD-185V 30S		1407	59,48/pc.
	400	UEBSMD-185V 40S		1407	65,43/pc.
<b>Couvercle de montage, trou 261 x 261</b>					
	Acier galvanisé Sendzimir				
	400	UEBSMD-260V 40S		1407	65,43/pc.

# Canaux de sol pour charges lourdes

	type	référence	page catal.	groupe d'articles	prix en €
<b>Base canal de sol</b>					
	Acier galvanisé Sendzimir				
	UBK	UBK 100-20S	A11	1401	48,37/m
	UBK	UBK 100-30S	A11	1401	57,88/m
	UBK	UBK 100-40S	A11	1401	70,18/m
	UBK	UBK 135-20S	A11	1401	53,53/m
	UBK	UBK 135-30S	A11	1401	64,24/m
	UBK	UBK 135-40S	A11	1401	76,53/m
	UBK	UBK 170-20S	A11	1401	59,48/m
	UBK	UBK 170-30S	A11	1401	69,78/m
	UBK	UBK 170-40S	A11	1401	80,88/m
<b>Couvercle pour canal de sol</b>					
	Acier galvanisé à chaud				
	UBKD	UBKD5 25F	A11	1401	298,57/m
	UBKD	UBKD5 35F	A11	1401	336,63/m
	UBKD	UBKD5 45F	A11	1401	377,08/m
	UBKD	UBKD8 25F	A11	1401	358,04/m
	UBKD	UBKD8 35F	A11	1401	423,47/m
	UBKD	UBKD8 45F	A11	1401	484,13/m
	UBKD	UBKD10 25F	A11	1401	394,92/m
	UBKD	UBKD10 35F	A11	1401	479,37/m
	UBKD	UBKD10 45F	A11	1401	556,69/m
<b>Profilé latéral</b>					
	Acier galvanisé à chaud				
	UBKPR	UBKPR5F	A12	1401	57,88/m
	UBKPR	UBKPR8F	A12	1401	75,34/m
	UBKPR	UBKPR10F	A12	1401	90,80/m
<b>Embout</b>					
	Acier galvanisé Sendzimir				
	UBKEB	UBKEB 100-20S	A13	1401	26,95/pc.
	UBKEB	UBKEB 100-30S	A13	1401	30,81/pc.
	UBKEB	UBKEB 100-40S	A13	1401	32,78/pc.
	UBKEB	UBKEB 135-20S	A13	1401	28,91/pc.
	UBKEB	UBKEB 135-30S	A13	1401	32,78/pc.
	UBKEB	UBKEB 135-40S	A13	1401	34,61/pc.
	UBKEB	UBKEB 170-20S	A13	1401	30,81/pc.
	UBKEB	UBKEB 170-30S	A13	1401	34,61/pc.
UBKEB	UBKEB 170-40S	A13	1401	36,58/pc.	
<b>Profilé pour courbe intérieure</b>					
	Acier galvanisé à chaud				
	UBKIB	UBKIB5F	A13	1401	134,42/pc.
	UBKIB	UBKIB8F	A13	1401	172,48/pc.
	UBKIB	UBKIB10F	A13	1401	210,55/pc.
<b>Profilé pour courbe extérieure</b>					
	Acier galvanisé à chaud				
	UBKAB	UBKAB5F	A13	1401	155,83/pc.
	UBKAB	UBKAB8F	A13	1401	203,41/pc.
	UBKAB	UBKAB10F	A13	1401	250,99/pc.

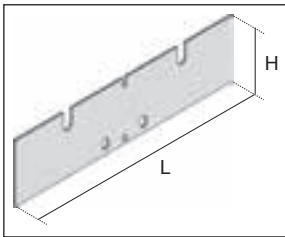
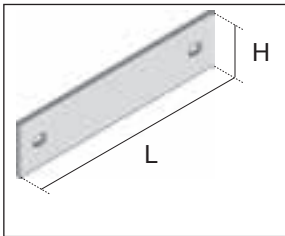
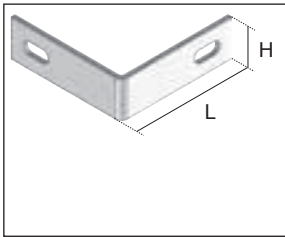
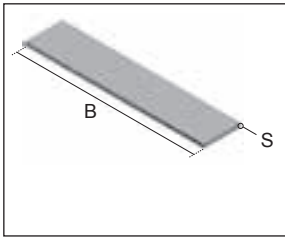
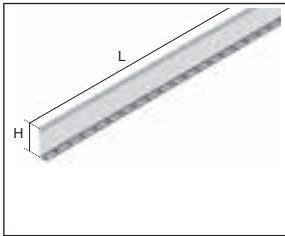
# Canaux de sol pour charges lourdes

	type	référence	page catal.	groupe d'articles	prix en €
	<b>Accouplement (base canal de sol)</b>				
	Acier galvanisé Sendzimir				
	UBKV	UBKV 100S	A14	1401	2,56/pc.
	UBKV	UBKV 135S	A14	1401	3,33/pc.
	UBKV	UBKV 170S	A14	1401	4,16/pc.
	<b>Accouplement</b>				
	Acier galvanisé Sendzimir				
		UBKPRV	A14	1401	4,28/pc.
	<b>Accouplement</b>				
	Acier galvanisé Sendzimir				
		UBKPRVE	A14	1401	5,30/pc.
	<b>Teneur de distance</b>				
	Acier galvanisé à chaud				
	UBKDB	UBKDB5 25F	A14	1401	3,93/pc.
	UBKDB	UBKDB5 35F	A14	1401	4,47/pc.
	UBKDB	UBKDB5 45F	A14	1401	5,71/pc.
	UBKDB	UBKDB8 25F	A14	1401	4,16/pc.
	UBKDB	UBKDB8 35F	A14	1401	4,88/pc.
UBKDB	UBKDB8 45F	A14	1401	6,02/pc.	
	<b>Cloison de séparation</b>				
	Acier galvanisé Sendzimir				
	UBKTR	UBKTR 100S	A14	1401	4,94/m
	UBKTR	UBKTR 135S	A14	1401	5,75/m
	UBKTR	UBKTR 170S	A14	1401	6,56/m
	<b>Ruban en caoutchouc (1 pc. = 10 m)</b>				
	Caoutchouc				
	UGD20	UGD 20-2	C55	1401	39,91/pc.

# Gaines de sol noyées fermées



	type	référence	page catal.	groupe d'articles	prix en €	
<b>Gaine de sol fermée, 2 compartiments</b>						
	Acier galvanisé Sendzimir					
		UK	UK 2-28-190S	B5	1403	41,64/m
		UK	UK 2-28-250S	B5	1403	45,20/m
		UK	UK 2-28-350S	B5	1403	63,05/m
		UK	UK 2-38-190S	B5	1403	43,61/m
		UK	UK 2-38-250S	B5	1403	47,58/m
		UK	UK 2-38-350S	B5	1403	64,64/m
		UK	UK 2-48-190S	B5	1403	44,80/m
		UK	UK 2-48-250S	B5	1403	49,17/m
	UK	UK 2-48-350S	B5	1403	66,22/m	
<b>Gaine de sol fermée, 3 compartiments</b>						
	Acier galvanisé Sendzimir					
		UKL	UKL 3-28-250S	B5	1403	46,39/m
		UKL	UKL 3-28-350S	B5	1403	63,45/m
		UKL	UKL 3-38-250S	B5	1403	51,94/m
		UKL	UKL 3-38-350S	B5	1403	65,43/m
		UKL	UKL 3-48-250S	B5	1403	57,09/m
	UKL	UKL 3-48-350S	B5	1403	67,40/m	
<b>Etrier de fixation</b>						
	Acier galvanisé Sendzimir					
		UB	UB 28-190S	B5	1403	6,78/pc.
		UB	UB 28-250S	B5	1403	6,96/pc.
		UB	UB 28-350S	B5	1403	7,80/pc.
		UB	UB 38-190S	B5	1403	6,96/pc.
		UB	UB 38-250S	B5	1403	7,08/pc.
		UB	UB 38-350S	B5	1403	7,80/pc.
		UB	UB 48-190S	B5	1403	7,08/pc.
		UB	UB 48-250S	B5	1403	7,32/pc.
	UB	UB 48-350S	B5	1403	7,97/pc.	
<b>Pièce de montée, 2 compartiments</b>						
	Acier galvanisé Sendzimir					
		UVB	UVB 2-28-190S	B6	1403	52,57/pc.
		UVB	UVB 2-28-250S	B6	1403	56,93/pc.
		UVB	UVB 2-28-350S	B6	1403	63,88/pc.
		UVB	UVB 2-38-190S	B6	1403	53,60/pc.
		UVB	UVB 2-38-250S	B6	1403	57,52/pc.
		UVB	UVB 2-38-350S	B6	1403	64,53/pc.
		UVB	UVB 2-48-190S	B6	1403	56,09/pc.
		UVB	UVB 2-48-250S	B6	1403	60,31/pc.
	UVB	UVB 2-48-350S	B6	1403	67,39/pc.	
<b>Pièce de montée, 3 compartiments</b>						
	Acier galvanisé Sendzimir					
		UVB	UVB 3-28-250S	B6	1403	63,11/pc.
		UVB	UVB 3-28-350S	B6	1403	75,42/pc.
		UVB	UVB 3-38-250S	B6	1403	67,80/pc.
		UVB	UVB 3-38-350S	B6	1403	79,10/pc.
		UVB	UVB 3-48-250S	B6	1403	71,97/pc.
	UVB	UVB 3-48-350S	B6	1403	90,70/pc.	

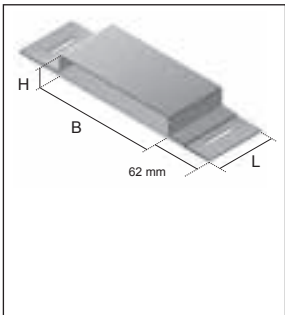
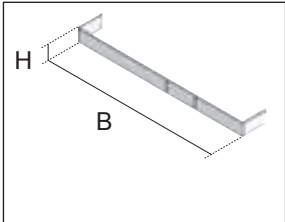
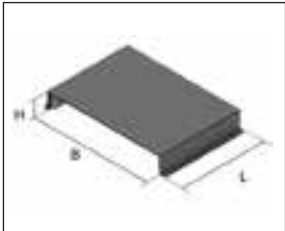
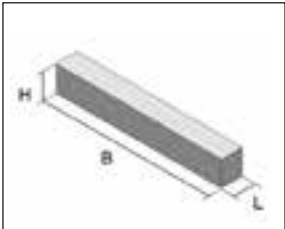

# Gaines de sol noyées fermées

	type	référence	page catal.	groupe d'articles	prix en €
<b>Manchon de fixation</b>					
	Acier galvanisé Sendzimir				
	UM	UM 28-190S	B6	1403	11,06/pc.
	UM	UM 28-250S	B6	1403	11,73/pc.
	UM	UM 28-350S	B6	1403	13,03/pc.
	UM	UM 38-190S	B6	1403	11,24/pc.
	UM	UM 38-250S	B6	1403	11,96/pc.
	UM	UM 38-350S	B6	1403	13,33/pc.
	UM	UM 48-190S	B6	1403	11,48/pc.
	UM	UM 48-250S	B6	1403	12,07/pc.
	UM	UM 48-350S	B6	1403	13,44/pc.
À utiliser aux endroits avec joints d'expansion.					
<b>Embout</b>					
	Acier galvanisé Sendzimir				
	UE	UE 28-350S	B7	1403	13,33/pc.
	UE	UE 38-350S	B7	1403	15,11/pc.
	UE	UE 48-350S	B7	1403	17,49/pc.
<b>Cloison anti-incendie</b>					
	Acier galvanisé Sendzimir				
	28-350	UKBS 28-350S		1403	501,97/pc.
	38-350	UKBS 38-350S		1403	523,39/pc.
	48-350	UKBS 48-350S		1403	547,18/pc.
<b>Bouchon en mousse Easyfoam</b>					
	Polycarbonate				
	30-390	UKBSR 28-350S		1403	20,64/pc.
	40-390	UKBSR 38-350S		1403	21,54/pc.
	50-390	UKBSR 48-350S		1403	22,60/pc.

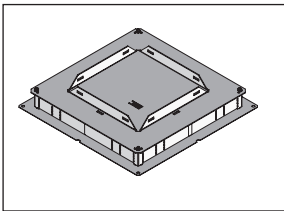
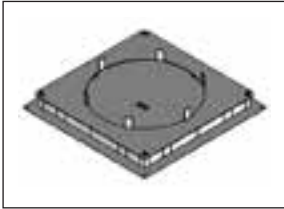
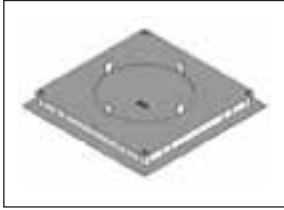
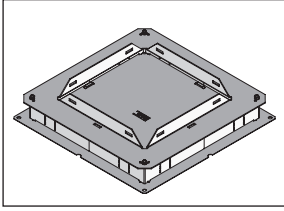
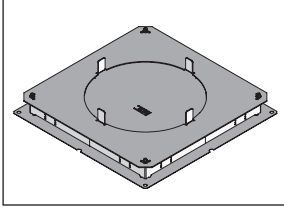
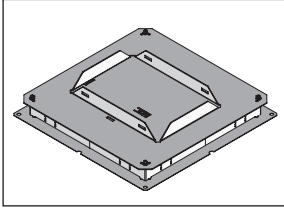
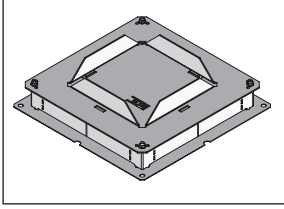
# Boîtes de construction vides

	type	référence	page catal.	groupe d'articles	prix en €	
	<b>Boîte de construction vide</b>					
	Acier galvanisé Sendzimir	262x262	UBDHB350 28-259V	B9	1402	110,98/pc.
		262x262	UBDHB350 38-259V	B9	1402	114,79/pc.
		262x262	UBDHB350 48-259V	B9	1402	121,33/pc.
	<b>Boîte de construction vide</b>					
	Acier galvanisé Sendzimir	Ø310	UBDHB350 28-308R	B9	1402	114,14/pc.
		Ø310	UBDHB350 38-308R	B9	1402	118,23/pc.
		Ø310	UBDHB350 48-308R	B9	1402	122,52/pc.
	<b>Boîte de construction vide</b>					
	Acier galvanisé Sendzimir	Ø260	UBDHB350 28-259R		1402	110,54/pc.
		Ø260	UBDHB350 38-259R		1402	114,95/pc.
		Ø260	UBDHB350 48-259R		1402	119,16/pc.
	<b>Boîte de construction vide</b>					
	Acier galvanisé Sendzimir	262x262	UBDHB250 28-259V	B10	1402	102,37/pc.
		262x262	UBDHB250 38-259V	B10	1402	105,22/pc.
		262x262	UBDHB250 48-259V	B10	1402	108,08/pc.
	<b>Boîte de construction vide</b>					
	Acier galvanisé Sendzimir	Ø260	UBDHB250 28-259R	B10	1402	103,14/pc.
		Ø260	UBDHB250 38-259R	B10	1402	106,05/pc.
		Ø260	UBDHB250 48-259R	B10	1402	108,78/pc.
	<b>Boîte de construction vide</b>					
	Acier galvanisé Sendzimir	187x262	UBDHB250 28-185V	B11	1402	94,63/pc.
		187x262	UBDHB250 38-185V	B11	1402	97,77/pc.
		187x262	UBDHB250 48-185V	B11	1402	101,11/pc.
	<b>Boîte de construction vide</b>					
	Acier galvanisé Sendzimir	165x165	UBDHB190 28-160V	B11	1402	90,17/pc.
		165x165	UBDHB190 38-160V	B11	1402	90,88/pc.
		165x165	UBDHB190 48-160V	B11	1402	91,59/pc.
	<b>Boîte de construction vide</b>					
	Acier galvanisé Sendzimir	Ø123	UBDHB 38-122R	B12	1406	61,14/pc.

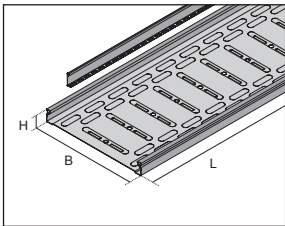
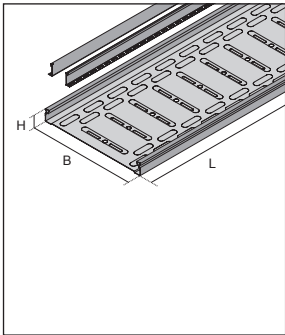
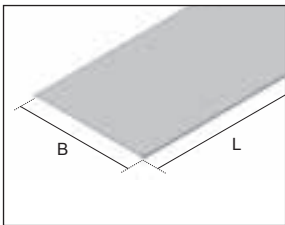
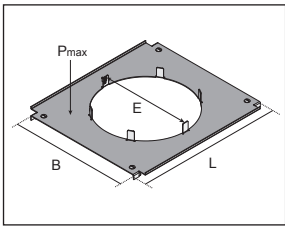
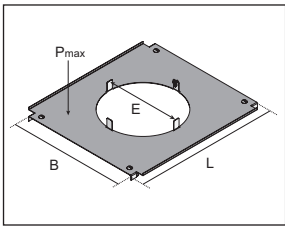
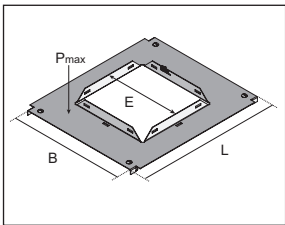
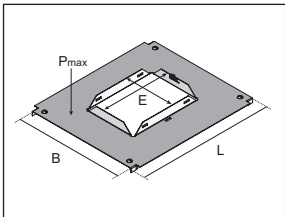

# Canaux de sol avec couvercle

	type	référence	page catal.	groupe d'articles	prix en €	
	<b>Base canal de sol, 2 compartiments</b>					
	Acier galvanisé Sendzimir	UKR	UKR 35-30S	B15	1402	22,32/m
	<b>Base canal de sol, 3 compartiments</b>					
	Acier galvanisé Sendzimir	UKR	UKR 35-40S	B15	1402	25,43/m
		UKR	UKR 35-50S	B15	1402	31,24/m
		UKR	UKR 60-40S	B15	1402	37,23/m
		UKR	UKR 60-50S	B15	1402	42,82/m
		UKR	UKR 85-40S	B15	1402	53,93/m
		UKR	UKR 85-50S	B15	1402	59,48/m
		UKR	UKR 110-40S	B15	1402	58,28/m
	UKR	UKR 110-50S	B15	1402	70,18/m	
	<b>Couvercle pour canal de sol</b>					
	Acier galvanisé Sendzimir	UKD	UKD 30S	B15	1402	23,32/m
		UKD	UKD 40S	B15	1402	26,78/m
	UKD	UKD 50S	B15	1402	32,30/m	
	<b>Couvercle de montage</b>					
	Acier galvanisé Sendzimir	Ø310	UKDA-308R 40S	B16	1402	56,03/pc.
		Ø310	UKDA-308R 50S	B16	1402	62,64/pc.
	<b>Couvercle de montage</b>					
	Acier galvanisé Sendzimir	Ø260	UKDA-260R 30S	B16	1402	50,08/pc.
		Ø260	UKDA-260R 40S	B16	1402	55,20/pc.
		Ø260	UKDA-260R 50S	B16	1402	61,97/pc.
	<b>Couvercle de montage</b>					
	Acier galvanisé Sendzimir	262x262	UKDA-260V 40S	B16	1402	55,73/pc.
		262x262	UKDA-260V 50S	B16	1402	62,33/pc.
	<b>Couvercle de montage</b>					
	Acier galvanisé Sendzimir	187x262	UKDA-185V 30S	B16	1402	42,18/pc.
		187x262	UKDA-185V 40S	B16	1402	49,01/pc.

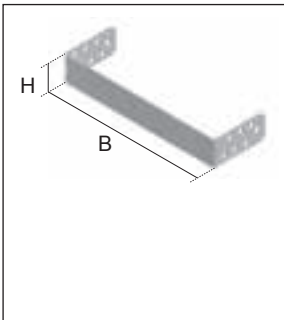
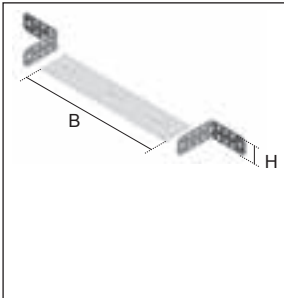
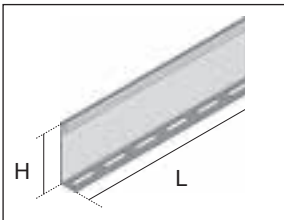
# Canaux de sol avec couvercle

	type	référence	page catal.	groupe d'articles	prix en €
	<b>Embout</b>				
	Acier galvanisé Sendzimir				
	UKEB	UKEB 35-30S	B17	1402	4,23/pc.
	UKEB	UKEB 35-40S	B17	1402	4,76/pc.
	UKEB	UKEB 35-50S	B17	1402	6,30/pc.
	UKEB	UKEB 60-40S	B17	1402	7,13/pc.
	UKEB	UKEB 60-50S	B17	1402	8,68/pc.
	UKEB	UKEB 85-40S	B17	1402	9,87/pc.
	UKEB	UKEB 85-50S	B17	1402	12,25/pc.
	<b>Dérivation</b>				
	Acier galvanisé Sendzimir				
	UKAZ	UKAZ 35-30S	B17	1402	11,06/pc.
	UKAZ	UKAZ 35-40S	B17	1402	11,06/pc.
	UKAZ	UKAZ 35-50S	B17	1402	11,73/pc.
	UKAZ	UKAZ 60-40S	B17	1402	11,60/pc.
	UKAZ	UKAZ 60-50S	B17	1402	12,92/pc.
	UKAZ	UKAZ 85-40S	B17	1402	17,85/pc.
	UKAZ	UKAZ 85-50S	B17	1402	17,85/pc.
	<b>Cloison de séparation</b>				
	Acier galvanisé Sendzimir				
	UKTR	UKTR 35S	B17	1402	3,47/m
	UKTR	UKTR 60S	B17	1402	10,23/m
	UKTR	UKTR 85S	B17	1402	10,01/m
	UKTR	UKTR 110S	B17	1402	12,30/m

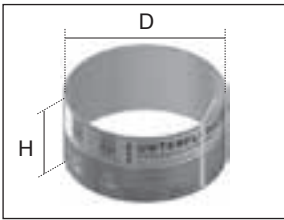
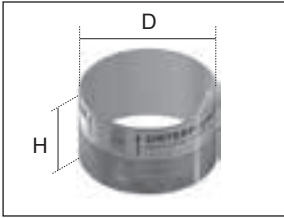
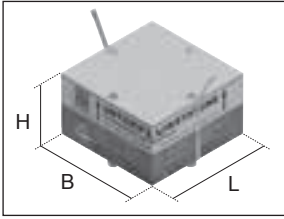
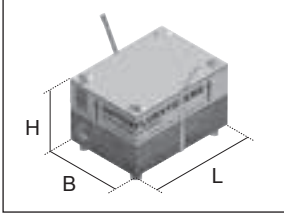
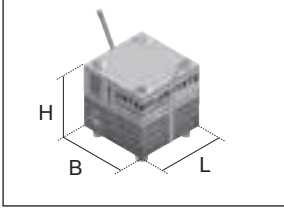
# Coffrages

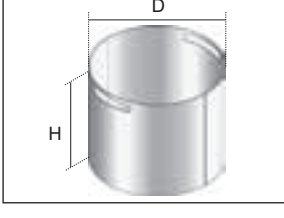
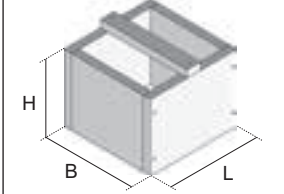



	type	référence	page catal.	groupe d'articles	prix en €
	<b>Tube de coffrage</b>				
	Carton	Ø308 Ø308	USR 308-150 USR 308-225	B19 B19	1402 1402
	<b>Tube de coffrage</b>				
	Carton	Ø259	USR 259-150	B19	1402
	<b>Corps de coffrage</b>				
	Polystyrène	261x261 261x261	USK 259V-150 USK 259V-225	B19 B19	1402 1402
	<b>Corps de coffrage</b>				
	Polystyrène	186x261	USK 185V-150	B19	1402
	<b>Corps de coffrage</b>				
	Polystyrène	164x164	USK 160V-150	B19	1402
	<b>Corps de coffrage</b>				
	Polystyrène	Ø122	USK 120R-150	B19	1406
	<b>Tube de coffrage, rond, résistant à la chaleur</b>				
	Acier galvanisé Sendzimir	Ø308	USRH 308-200	B19	1402
	<b>Corps de coffrage, carré, résistant à la chaleur</b>				
	Bois	261x261	USKH 259V-200	B19	1402

# Accessoires

	type	référence	page catal.	groupe d'articles	prix en €
	<b>Cheville à frapper</b> Acier galvanisé cheville en PVC	UN 5/38	B21	1402	12,64/bt.
	1 boîte = 50 pièces				
	<b>Cheville à frapper</b> Acier galvanisé cheville en acier	SNA 6x30/5	B21	1402	158,21/bt.
	1 boîte = 100 pièces				
	<b>Ruban adhésif avec tissu</b>	UGKB	B21	1402	29,03/pc.
	1 pc. = 50 m				
	<b>Adhésif bitumes</b>	UBKM	B21	1402	35,86/pc.
	<b>Languette de terre</b> Acier galvanisé Sendzimir	UBDEL	B21	1402	10,18/pc.
	<b>Borne de terre</b> Acier galvanisé Sendzimir	UBDHB-Z	B21	1402	2,02/pc.

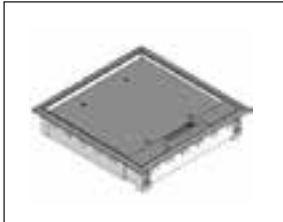

# Boîtes de sol avec rebord

	type	référence	page catal.	groupe d'articles	prix en €
	<b>Boîte de tirage triple, ronde</b>				
	Polyamide	gris noir	UEB3-R-G UEB3-R-S	1402 1402	43,04/pc. 43,04/pc.
	<b>Boîte de raccordement triple, ronde, sortie avec brosse</b>				
	Polyamide	gris noir	UEK3-R-G UEK3-R-S	1402 1402	64,94/pc. 64,94/pc.
	<b>Boîte de tirage triple, carrée</b>				
	Polyamide	gris noir	UEB3-V-G UEB3-V-S	1402 1402	40,96/pc. 40,96/pc.
	<b>Boîte de raccordement triple, carrée, sortie avec brosse</b>				
	Polyamide	gris noir	UEK3-V-G UEK3-V-S	1402 1402	53,53/pc. 53,53/pc.
	<b>Set de montage pour boîte de raccordement, sortie avec brosse</b>				
	Acier galvanisé Sendzimir	UGEA3 UGEA3	UGEA3-50-S UGEA3-80-S	1402 1402	9,99/set 11,78/set

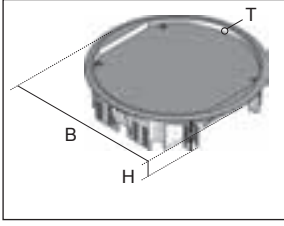
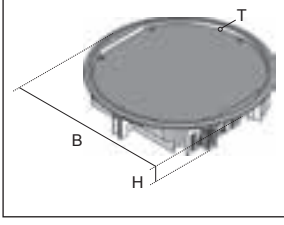
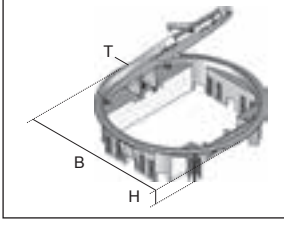
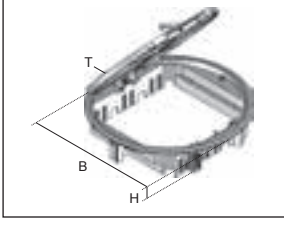
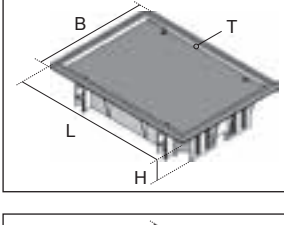
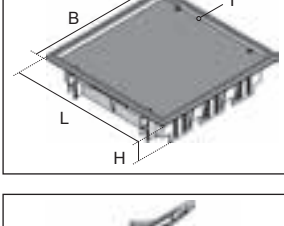
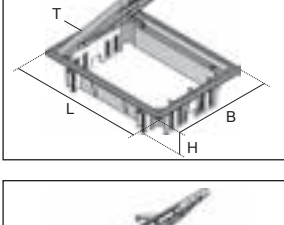
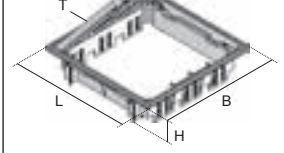

# Boîtes de sol avec rebord

	type	référence	page catal.	groupe d'articles	prix en €
	<b>Boîte de tirage double, ronde</b>				
	Polyamide	gris noir	UEBD2-R-G UEBD2-R-S	C5 C5	1402 1402
	<b>Boîte de tirage triple, ronde</b>				
	Polyamide	gris noir	UEBD3-R-G UEBD3-R-S	C5 C5	1402 1402
	<b>Boîte de raccordement double, ronde</b>				
	Polyamide	gris noir	UEKD2-R-G UEKD2-R-S	C6 C6	1402 1402
	<b>Boîte de raccordement triple, ronde</b>				
	Polyamide	gris noir	UEKD3-R-G UEKD3-R-S	C6 C6	1402 1402
	<b>Boîte de tirage double, rectangulaire</b>				
	Polyamide	gris noir	UEBD2-V-G UEBD2-V-S	C7 C7	1402 1402
	<b>Boîte de tirage triple, carrée</b>				
	Polyamide	gris noir	UEBD3-V-G UEBD3-V-S	C7 C7	1402 1402
	<b>Boîte de raccordement double, rectangulaire</b>				
	Polyamide	gris noir	UEKD2-V-G UEKD2-V-S	C8 C8	1402 1402
	<b>Boîte de raccordement triple, carrée</b>				
	Polyamide	gris noir	UEKD3-V-G UEKD3-V-S	C8 C8	1402 1402

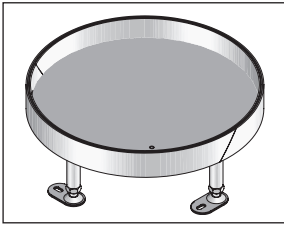
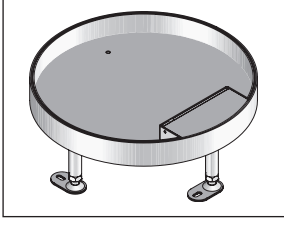
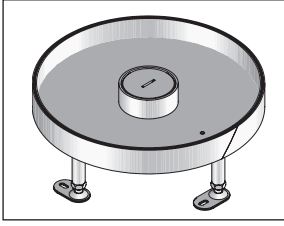
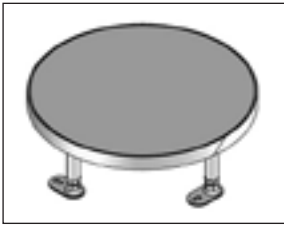

# Boîtes de sol avec rebord

	type	référence	page catal.	groupe d'articles	prix en €	
	<b>Boîte de tirage triple, carrée</b>					
	INOX	12 mm 22 mm	UEBDD 15-V E UEBDD 25-V E	C24 C24	1402 1402	304,52/pc. 324,74/pc.
	<b>Boîte de raccordement triple, carrée</b>					
	INOX	12 mm 22 mm	UEKDD 15-V E UEKDD 25-V E	C24 C24	1402 1402	336,63/pc. 356,85/pc.
	<b>Boîte de tirage double, rectangulaire</b>					
	INOX	12 mm 22 mm	UEBDD2 15-V E UEBDD2 25-V E	C25 C25	1402 1402	226,01/pc. 235,52/pc.
	<b>Boîte de raccordement double, rectangulaire</b>					
	INOX	12 mm 22 mm	UEKDD2 15-V E UEKDD2 25-V E	C25 C25	1402 1402	318,79/pc. 339,01/pc.
	<b>Boîte de tirage, carrée</b>					
	INOX	12 mm 22 mm	UEBDD1-2 15-V E UEBDD1-2 25-V E		1402 1402	135,61/pc. 137,99/pc.
	<b>Boîte de raccordement, carrée</b>					
	INOX	12 mm 22 mm	UEKDD1-2 15-V E UEKDD1-2 25-V E	C26 C26	1402 1402	174,85/pc. 189,13/pc.
	<b>Boîte de raccordement BODO, ronde</b>					
	Aluminium		BODO NL	C30	1406	298,79/pc.
		noir	BODO NL-SW		1406	403,26/pc.
		messing	BODO NL-MS		1406	403,26/pc.
	<b>Boîte de raccordement BODO, ronde</b>					
	ABS	gris noir	BODO TL-G BODO TL-S	C31 C31	1406 1406	51,83/pc. 51,83/pc.

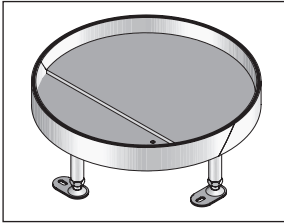
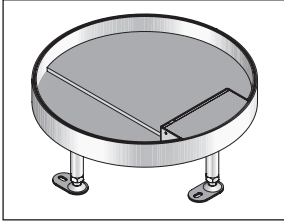
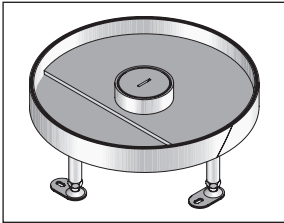
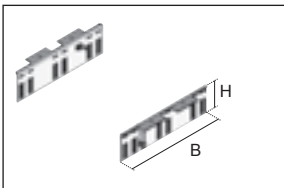

# Boîtes de sol avec rebord de marquage

	type	référence	page catal.	groupe d'articles	prix en €
	<b>Cassette de nivellement + couvercle aveugle, rond</b>				
	INOX				
	2 kN	UEBD 15-R E	C11	1402	339,01/set
	2 kN	UEBD 35-R E	C11	1402	388,97/set
	<b>Cassette de nivellement + couvercle avec sortie latérale, rond</b>				
	INOX				
	2 kN	UEKD 15-R E	C11	1402	412,76/set
	2 kN	UEKD 35-R E	C11	1402	472,24/set
	<b>Cassette de nivellement + couvercle avec sortie centrale, rond</b>				
	INOX				
	2 kN	UEBDM 15-R-WD	C12	1402	425,85/set
	2 kN	UEBDM 35-R-WD	C12	1402	493,65/set
	<b>Cassette de nivellement + couvercle rempli, aveugle, rond</b>				
	INOX	4 kN	UEBD 15-RP E	1402	496,03/set
	<b>Cassette de nivellement + couvercle rempli avec sortie latérale, rond</b>				
	INOX	4 kN	UEKD 15-RP E	1402	570,97/set
	<b>Cassette de nivellement + couvercle rempli avec sortie centrale, rond</b>				
	INOX	4 kN	UEBDM 15-RP-WD	1402	657,80/set

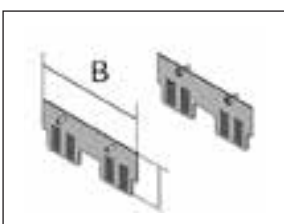
# Boîtes de sol avec rebord de marquage

	type	référence	page catal.	groupe d'articles	prix en €	
	<b>Cassette de nivellement + couvercle aveugle, rond</b>					
	INOX	20 kN	UEBDS 35-R6 E	C12	1402	510,30/set
	<b>Cassette de nivellement + couvercle avec sortie latérale, rond</b>					
	INOX	10 kN	UEKDS 35-R6 E	C13	1402	590,00/set
	<b>Cassette de nivellement + couvercle avec sortie centrale, rond</b>					
	INOX	20 kN	UEBDSM 35-R6-WD	C13	1402	606,66/set
	<b>Set de montage, ronde</b>					
	Acier galvanisé Sendzimir	UGEAR	UGEAR-50S	C14	1402	35,39/set
		UGEAR	UGEAR-80S	C14	1402	37,23/set
	<b>Cassette de nivellement + couvercle aveugle, rectangulaire</b>					
	INOX	1,5 kN	UEBD2 15-V E	C19	1402	184,38/pc.
		1,5 kN	UEBD2 25-V E	C19	1402	199,83/pc.
	<b>Cassette de nivellement + couvercle avec sortie latérale, rectangulaire</b>					
	INOX	1,5 kN	UEKD2 15-V E	C19	1402	255,75/pc.
		1,5 kN	UEKD2 25-V E	C19	1402	279,54/pc.
	<b>Set de montage, rectangulaire</b>					
	Acier galvanisé Sendzimir	UGEAV	UGEAV2-50S	C20	1402	9,99/set

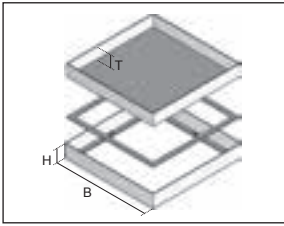
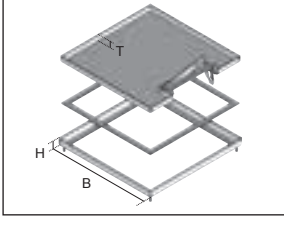
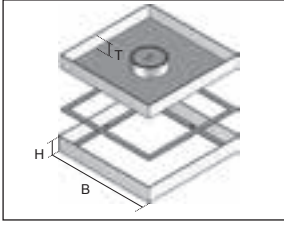
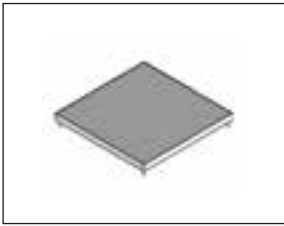
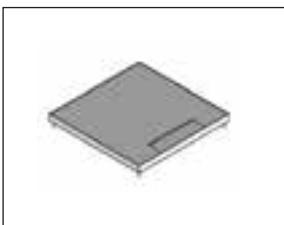
# Boîtes de sol avec rebord de marquage





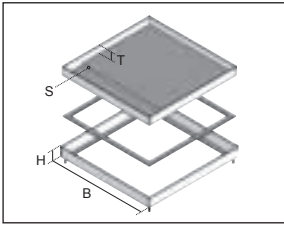
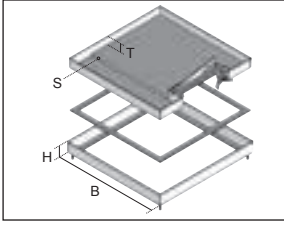
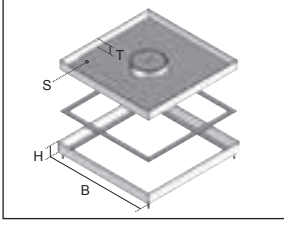
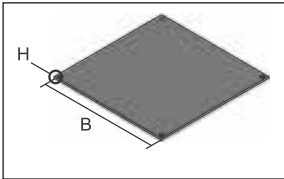
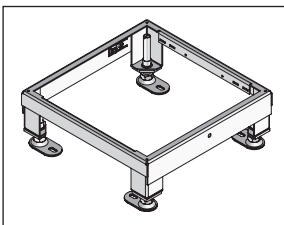
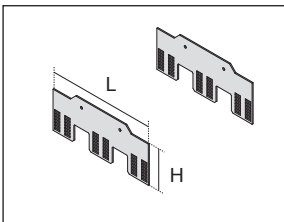

	type	référence	page catal.	groupe d'articles	prix en €
	<b>Cassette + couvercle aveugle, carré</b>				
	INOX				
	2 kN	UEBD 15-V E	C15	1402	161,78/set
	2 kN	UEBD 25-V E	C15	1402	172,48/set
	2 kN	UEBD 35-V E	C15	1402	205,79/set
	2 kN	UEBD 45-V E	C15	1402	224,81/set
	<b>Cassette + couvercle avec sortie latérale, carré</b>				
	INOX				
	2 kN	UEKD 15-V E	C15	1402	229,58/set
	2 kN	UEKD 25-V E	C15	1402	242,66/set
	2 kN	UEKD 35-V E	C15	1402	260,50/set
	2 kN	UEKD 45-V E	C15	1402	279,54/set
	<b>Cassette + couvercle avec sortie centrale, carré</b>				
	INOX				
	2 kN	UEBDM 15-V-WD	C16	1402	254,56/set
	2 kN	UEBDM 25-V-WD	C16	1402	292,62/set
	2 kN	UEBDM 35-V-WD	C16	1402	303,33/set
	2 kN	UEBDM 45-V-WD	C16	1402	310,46/set
	<b>Cassette + couvercle aveugle, rempli, carré</b>				
	INOX	4 kN	UEBD 15-VP E	1402	262,88/set
	<b>Cassette + couvercle rempli avec sortie latérale, carré</b>				
	INOX	4 kN	UEKD 15-VP E	1402	334,25/set
	<b>Cassette + couvercle rempli avec sortie centrale, carré</b>				
	INOX	4 kN	UEBDM 15-VP-WD	1402	416,33/set



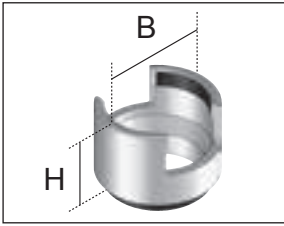

# Boîtes de sol avec rebord de marquage

	type	référence	page catal.	groupe d'articles	prix en €
	<b>Cassette + couvercle aveugle, carré</b>				
	INOX				
	10 kN	UEBDS 25-V6 E	C16	1402	210,55/set
	10 kN	UEBDS 35-V6 E	C16	1402	245,04/set
	10 kN	UEBDS 45-V6 E	C16	1402	264,07/set
	20 kN	UEBDS 35-V8 E	C16	1402	247,41/set
	20 kN	UEBDS 45-V8 E	C16	1402	266,45/set
	<b>Cassette + couvercle avec sortie latérale, carré</b>				
	INOX				
	10 kN	UEKDS 25-V6 E	C17	1402	280,73/set
	10 kN	UEKDS 35-V6 E	C17	1402	298,57/set
	10 kN	UEKDS 45-V6 E	C17	1402	317,60/set
	<b>Cassette + couvercle avec sortie centrale, carré</b>				
	INOX				
	10 kN	UEBDSM 25-V6-WD	C17	1402	346,15/set
	10 kN	UEBDSM 35-V6-WD	C17	1402	354,48/set
	10 kN	UEBDSM 45-V6-WD	C17	1402	369,94/set
	20 kN	UEBDSM 35-V8-WD	C17	1402	358,04/set
	20 kN	UEBDSM 45-V8-WD	C17	1402	374,70/set
	<b>Plaque aveugle, carrée</b>				
	Acier galvanisé Sendzimir	UBP-V 4S	C18	1402	36,82/pc.
	<b>Unité de nivellement, aveugle</b>				
	Acier galvanisé Sendzimir				
	UNE	UNE 260V-30S	C18	1402	78,09/pc.
	UNE	UNE 260V-60S	C18	1402	79,77/pc.
	UNE	UNE 260V-100S	C18	1402	82,26/pc.
	UNE	UNE 260V-155S	C18	1402	92,30/pc.
	UNE	UNE 260V-210S	C18	1402	111,64/pc.
	<b>Set de montage, carré</b>				
	Acier galvanisé Sendzimir				
	UGEAV	UGEAV-50S	C20	1402	9,99/set
	UGEAV	UGEAV-80S	C20	1402	11,78/set

# Boîtes de sol avec rebord de marquage

	type	référence	page catal.	groupe d'articles	prix en €	
	<b>Cylindre</b>					
	Aluminium	UET	UET-R-WD	C54	1402	79,69/pc.
	INOX	UET	UET-R-WD E	C54	1402	215,30/pc.
	<b>Couvercle pour cylindre</b>					
	Aluminium	UETD	UETD-R-WD	C54	1402	78,81/pc.
	INOX	UETD	UETD-R-WD E	C54	1402	153,44/pc.
	<b>Cylindre</b>					
	Aluminium	UET112	UET112-R-WD		1402	88,73/pc.
	<b>Couvercle pour cylindre</b>					
	Aluminium	UETD112	UETD112-R-WD		1402	84,57/pc.
	<b>Ventouse</b>					
		USH	USH 40		1402	39,44/pc.
	<b>Boîte de construction, coffrage et boîte de sol avec sortie latérale</b>					
	INOX	125x125	UKE125 15-V E		1402	261,69/pc.
		125x125	UKE125 25-V E		1402	285,48/pc.
	Laiton	125X125	UKE125 25-V MS		1402	440,12/pc.
	<b>Boîte de construction, coffrage et boîte de sol avec sortie centrale</b>					
	INOX	125x125	UKE125 15-VP-WD		1402	374,70/pc.

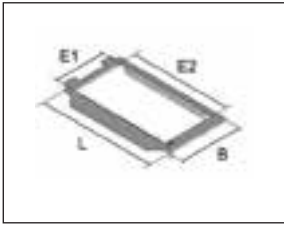
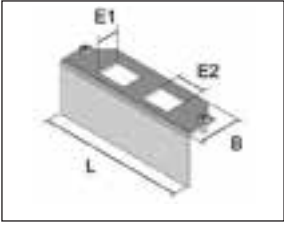
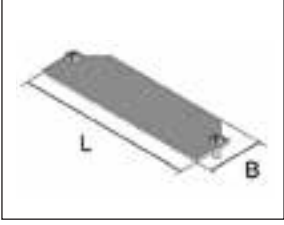
# Boîtes de sol avec rebord de marquage

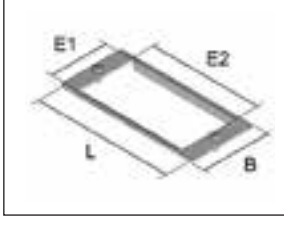
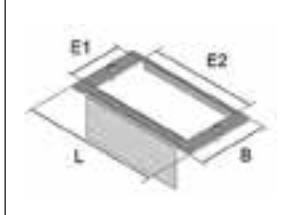
	type	référence	page catal.	groupe d'articles	prix en €
	<b>Support d'appareillage pour 2 modules (45x45)</b>				
	Acier	UEP	UEP125-UST 2	1408	5,71/pc.
	<b>Support d'appareillage avec cloison de séparation pour 2 modules Keystone RJ45</b>				
	Acier	UEP	UEP125-KS 2	1408	4,52/pc.
	<b>Support d'appareillage aveugle</b>				
	Acier	UEP	UEP125-B	1408	2,24/pc.
	<b>Boîte de construction, coffrage et boîte de sol avec sortie latérale</b>				
	INOX	160x160	UKE160 15-V E	1402	285,48/pc.
		160x160	UKE160 25-V E	1402	321,17/pc.
	Laiton	160x160	UKE160 25-V MS	1402	481,75/pc.
	<b>Boîte de construction, coffrage et boîte de sol avec sortie centrale</b>				
	INOX	160x160	UKE160 15-VP-WD	1402	392,54/pc.
	<b>Support d'appareillage pour 2 modules (45x45)</b>				
	Acier	UEP	UEP160-UST 2	1408	5,71/pc.
	<b>Support d'appareillage avec cloison de séparation pour 2 modules 45x45</b>				
	Acier	UEP	UEP160-UST 2-TR	1408	8,45/pc.



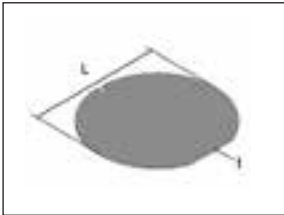
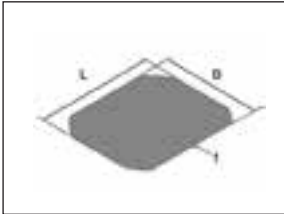
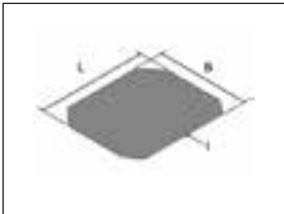
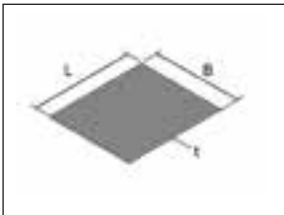
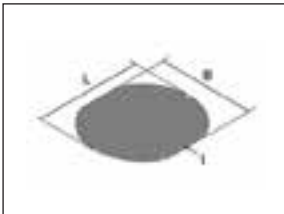
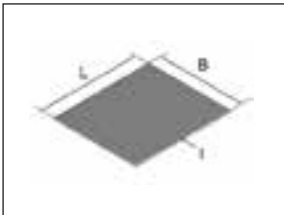
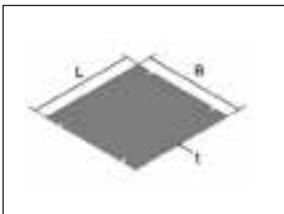
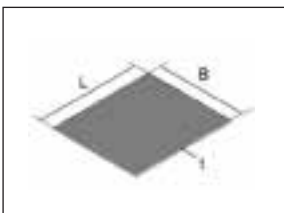

# Boîtes de sol avec rebord de marquage

	type	référence	page catal.	groupe d'articles	prix en €
	<b>Cassette de nivellement + couvercle aveugle (2x 45x45)</b>				
	INOX				
	160x160	UEBD1-2 15-V E	C37	1402	148,69/pc.
	160x160	UEBD1-2 25-V E	C37	1402	158,21/pc.
	<b>Cassette de nivellement + couvercle avec sortie latérale (2x 45x45)</b>				
	INOX				
	160x160	UEKD1-2 15-V E	C37	1402	196,27/pc.
	160x160	UEKD1-2 25-V E	C37	1402	212,92/pc.
	<b>Cassette de nivellement + couvercle avec sortie centrale (2x 45x45)</b>				
	INOX				
	160x160	UEBDSM1-2 15-V8-WD		1402	291,43/pc.
	<b>Set de montage, carré</b>				
	Acier galvanisé Sendzimir				
	UGEAV	UGEAV1-2 50S	C39	1402	9,99/set
	<b>Boîte d'appareillage ronde prémontée</b>				
	Acier galvanisé Sendzimir				
	160x160	UGR1-4	C39	1408	38,90/set



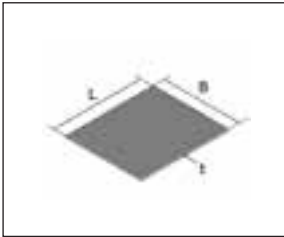
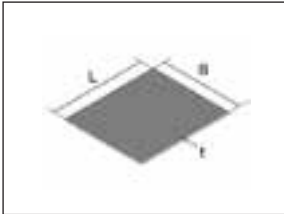

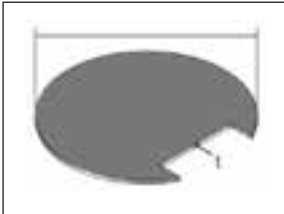
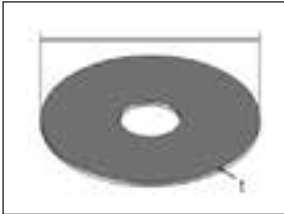
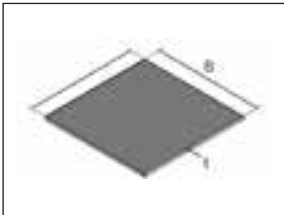
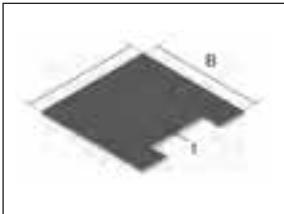
# Remplissages pour boîtes de sol

	type	référence	page catal.	groupe d'articles	prix en €
<b>Remplissage pour couvercle aveugle, rond, en matière synthétique</b>					
	Carton	2 mm	UEB3-R 2	1402	3,21/pc.
		5 mm	UEB3-R 5	1402	3,79/pc.
<b>Remplissage pour couvercle à charnière, rond, en matière synthétique, avec brosse</b>					
	Carton	2 mm	UEK3-R 2	1402	3,45/pc.
		5 mm	UEK3-R 5	1402	3,45/pc.
<b>Remplissage pour couvercle aveugle, carré, en matière synthétique</b>					
	Carton	2 mm	UEB3-V 2	1402	3,16/pc.
		5 mm	UEB3-V 5	1402	3,16/pc.
<b>Remplissage pour couvercle à charnière, carré, en matière synthétique, avec brosse</b>					
	Carton	2 mm	UEK3-V 2	1402	2,14/pc.
		5 mm	UEK3-V 5	1402	2,14/pc.
<b>Remplissage pour couvercle aveugle, rond, en matière synthétique</b>					
	Carton	double	UEBD2-R 3	C49 1402	2,86/pc.
		triple	UEBD3-R 3	C49 1402	3,21/pc.
<b>Remplissage pour couvercle à charnière, rond, en matière synthétique</b>					
	Carton	double	UEKD2-R 3	C49 1402	3,10/pc.
		triple	UEKD3-R 3	C49 1402	3,45/pc.
<b>Remplissage pour couvercle aveugle, carré, en matière synthétique</b>					
	Carton	double	UEBD2-V 3	C49 1402	2,97/pc.
		triple	UEBD3-V 3	C49 1402	3,16/pc.
<b>Remplissage pour couvercle à charnière, carré, en matière synthétique</b>					
	Carton	double	UEKD2-V 3	C49 1402	1,78/pc.
		triple	UEKD3-V 3	C49 1402	2,14/pc.

# Remplissages pour boîtes de sol

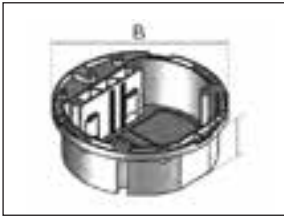
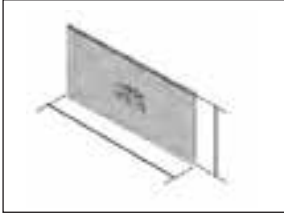
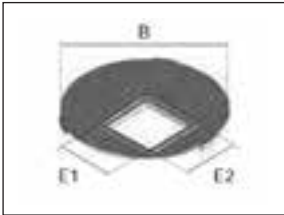
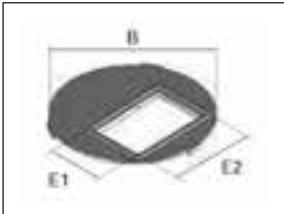
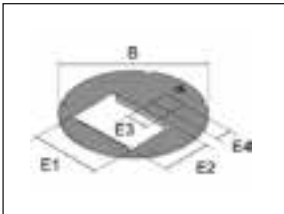
	type	référence	page catal.	groupe d'articles	prix en €
<b>Remplissage pour couvercle à charnière, rond, en matière synthétique</b>					
	PVC	triple UEKD3-R 5K	C49	1402	16,89/pc.
<b>Remplissage pour couvercle à charnière, carré, en matière synthétique</b>					
	PVC	triple UEKD3-V 5K	C49	1402	7,62/pc.
<b>Remplissage pour couvercle aveugle triple, rond, en inox</b>					
	PVC	triple UEBDE3-R 6	C53	1402	28,31/pc.
<b>Remplissage pour couvercle avec sortie latérale triple, rond, en inox</b>					
	PVC	triple UEKDE3-R 6	C53	1402	30,22/pc.
<b>Remplissage pour couvercle avec sortie centrale triple, rond, en inox</b>					
	PVC	triple UEBDME3-R 6	C53	1402	36,04/pc.
<b>Remplissage pour couvercle aveugle triple en inox, carré</b>					
	PVC	triple UEBDE3-V 6	C53	1402	13,56/pc.
<b>Remplissage pour couvercle avec sortie latérale triple, rond, en inox</b>					
	PVC	triple UEKDE3-V 6	C53	1402	17,61/pc.
<b>Remplissage pour couvercle avec sortie centrale triple en inox, carré</b>					
	PVC	triple UEBDME3-V 6	C53	1402	25,45/pc.

# Boîtes d'appareillage et plaques de recouvrement



	type	référence	page catal.	groupe d'articles	prix en €	
<b>Boîte d'appareillage, ronde</b>						
	ABS	UG-R	UG-R	D5	1406	7,97/pc.
<b>Cloison de séparation</b>						
	ABS	UTG	UTG 75	D5	1406	1,61/pc.
<b>Plaque de recouvrement pour 2 x 45x22,5 mm</b>						
	ABS	UARM	UARM-2-1 118	D5	1406	2,33/pc.
<b>Plaque de recouvrement pour 3 x 45x22,5 mm</b>						
	ABS	UARM	UARM-3-1 118	D5	1406	2,26/pc.
<b>Plaque de recouvrement pour 3 x 45x22,5 mm + 1 x Keystone</b>						
	ABS	UARM	UARM-3-KS1 118S	D5	1406	10,95/pc.
<b>Plaque de recouvrement pour RJ45 et TV</b>						
	Acier	UBE	UBE-AMPSL-TV		1406	12,32/pc.
<b>Plaque de recouvrement pour 2 x RJ45 (Keystone)</b>						
	Acier	UBE	UBE-KS 2		1406	12,32/pc.
<b>Clé inbus</b>						
	Acier	UWZ	UWZ-IS 8	C57	1406	4,28/pc.

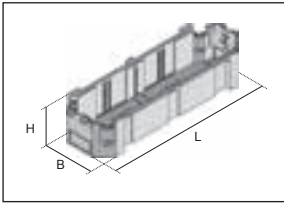
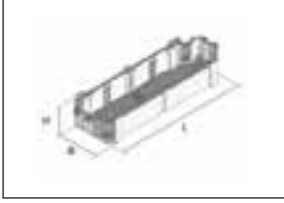
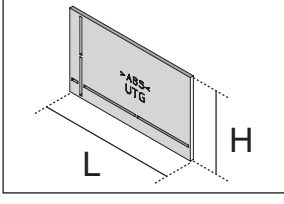
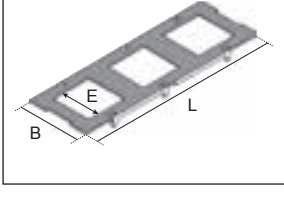
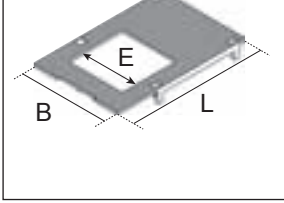
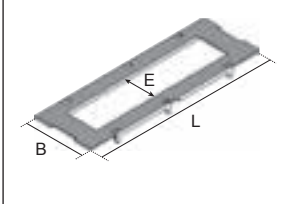
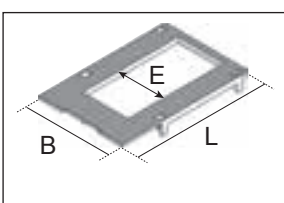
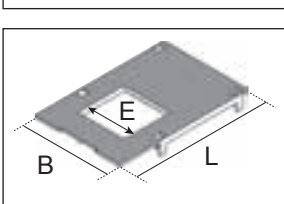

# Boîtes d'appareillage et plaques de recouvrement

	type	référence	page catal.	groupe d'articles	prix en €
	<b>Boîte d'appareillage, rectangulaire, 46x74x226</b>				
	ABS	UG	D7	1408	4,76/pc.
	<b>Boîte d'appareillage, rectangulaire, 38x74x225</b>				
	ABS	UG3		1408	4,76/pc.
	<b>Cloison de séparation</b>				
	ABS	UTG	D7	1408	1,42/pc.
	<b>Plaque de recouvrement 3x (50x50)</b>				
	ABS	UA	UA-3-1 226	D7	1408
	<b>Plaque de recouvrement 1x (50x50)</b>				
	ABS	UA	UA-1-1 113	D7	1408
	<b>Plaque de recouvrement 4x (45x45)</b>				
	ABS	UAM	UAM-4-1 226	D7	1408
	<b>Plaque de recouvrement 2x (45x45)</b>				
	ABS	UAM	UAM-2-1 113	D8	1408
	<b>Plaque de recouvrement 1x (45x45)</b>				
	ABS	UAM	UAM-1-1 113	D8	1408

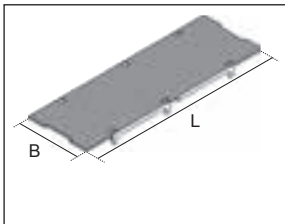
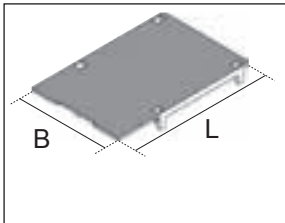
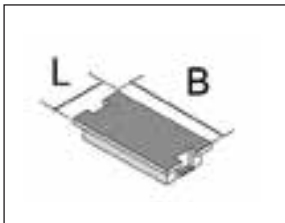
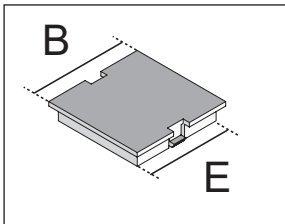
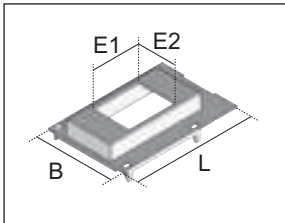
# Boîtes d'appareillage et plaques de recouvrement

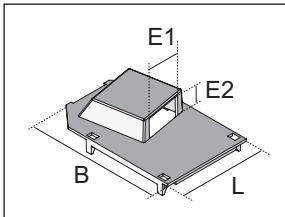
	type	référence	page catal.	groupe d'articles	prix en €	
<b>Plaque de recouvrement 1x aveugle</b>						
	ABS	UA-B	UA-B 226	D8	1408	2,61/pc.
<b>Plaque de recouvrement 1/2x aveugle</b>						
	ABS	UA-B	UA-B 113	D8	1408	1,42/pc.
<b>Obturbateur</b>						
	ABS	UAA	UAA-B 22	D8	1408	1,31/pc.
<b>Obturbateur</b>						
	ABS	UAA	UAA-B 45	D8	1408	1,37/pc.
<b>Plaque de recouvrement pour disjoncteur 2P</b>						
	ABS	UALS	UALS-2-1 113	D8	1408	15,17/pc.
<b>Boîte d'appareillage ouverte, rectangulaire</b>						
	ABS		UG45-4	D7	1408	5,47/pc.
<b>Plaque de recouvrement pour connecteur rapide</b>						
	ABS	UAVS	UAVS-1-1 113	D8	1408	2,86/pc.





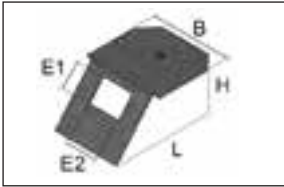
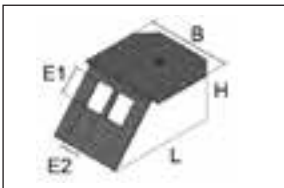
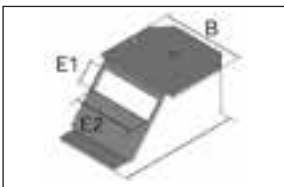
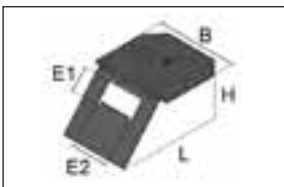
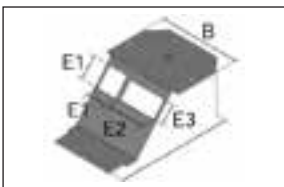
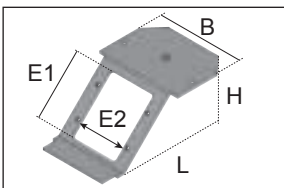
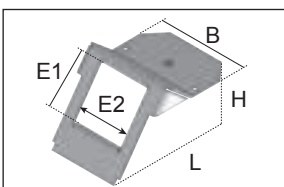
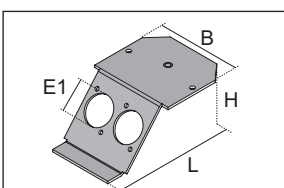

# Boîtes d'appareillage et plaques de recouvrement

	type	référence	page catal.	groupe d'articles	prix en €
	<b>Technique lumière</b>				
	Acier galvanisé Sendzimir				
	UGET	UGET-3-SCD 113	D9	1408	18,39/pc.
	<b>Technique lumière</b>				
	Acier galvanisé Sendzimir				
	UGET	UGET-3-SCS 113	D9	1408	18,39/pc.
	<b>Technique lumière</b>				
	Acier galvanisé Sendzimir				
	UGET	UGET-2-LCDM 113	D9	1408	17,13/pc.
	<b>Technique de données</b>				
	Acier galvanisé Sendzimir				
	UGET	UGET-2-BTR 113	D10	1408	17,13/pc.
	<b>Technique de données</b>				
	Acier galvanisé Sendzimir				
	UGET	UGET-2-COR 113	D10	1408	17,36/pc.
	<b>Technique de données</b>				
	Acier galvanisé Sendzimir				
	UGET	UGET-2-AMP 113	D10	1408	17,13/pc.
	<b>Technique de données</b>				
	Acier galvanisé Sendzimir				
	UGET	UGET-2-AMPSL 113	D10	1408	17,13/pc.
	<b>Technique de données</b>				
	Acier galvanisé Sendzimir				
	UGET	UGET-2-GG45 113	D11	1408	17,13/pc.

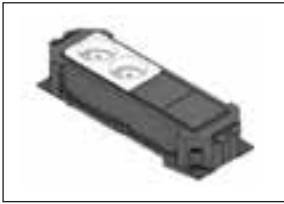
# Boîtes d'appareillage et plaques de recouvrement

	type	référence	page catal.	groupe d'articles	prix en €
	<b>Technique de données</b>				
Acier galvanisé Sendzimir	UGET	UGET-2-KR 113	D11	1408	17,13/pc.
	<b>Technique de données</b>				
Acier galvanisé Sendzimir	UGET	UGET-1-RM 113	D11	1408	17,13/pc.
	<b>Technique de données</b>				
Acier galvanisé Sendzimir	UGET	UGET-2-RMSC 113	D11	1408	17,13/pc.
	<b>Technique de connexion</b>				
Acier galvanisé Sendzimir	UGET	UGET-1-5PK 113	D12	1408	17,36/pc.
	<b>Technique de connexion</b>				
Acier galvanisé Sendzimir	UGET	UGET-1-5PCOM 113	D12	1408	17,36/pc.
	<b>Technique de connexion</b>				
Acier galvanisé Sendzimir	UGET	UGET-2-3PK 113	D12	1408	18,08/pc.
	<b>Technique audio et vidéo</b>				
Acier galvanisé Sendzimir	UGET	UGET-2-KM 113	D9	1408	18,91/pc.
	<b>Modules 45 x 45 mm</b>				
Acier galvanisé Sendzimir	UGET	UGET-1-UST45 113	D9	1408	20,05/pc.
	<b>Technique audio et vidéo</b>				
Acier galvanisé Sendzimir	UGET	UGET-2-XLR 113	D9	1408	16,56/pc.

# Boîtes d'appareillage et plaques de recouvrement

	type	référence	page catal.	groupe d'articles	prix en €
	<b>Boîte d'appareillage, prémontée, WAGO</b>				
	2 prises blanches connectées à un connecteur noir	UG45FRWA-W2	C44	1408	44,63/pc.
	2 prises rouges connectées à un connecteur blanc	UG45FRWA-R2	C44	1408	46,65/pc.
	<b>Boîte d'appareillage, prémontée, WAGO</b>				
	4 prises blanches connectées à un connecteur noir	UG45FRWA-W4	C44	1408	65,38/pc.
	<b>Boîte d'appareillage, prémontée, WAGO</b>				
	2 prises blanches connectées à un connecteur noir et 2 prises rouges connectées à un connecteur blanc	UG45FRWA-W2R2	C44	1408	74,11/pc.
	<b>Boîte d'appareillage, prémontée Wieland</b>				
	2 prises blanches connectées à un connecteur noir	UG45FRWI-W2	C45	1408	44,63/pc.
	2 prises rouges connectées à un connecteur blanc	UG45FRWI-R2	C45	1408	46,65/pc.
	<b>Boîte d'appareillage, prémontée Wieland</b>				
	4 prises blanches connectées à un connecteur noir	UG45FRWI-W4	C45	1408	65,38/pc.
	<b>Boîte d'appareillage, prémontée Wieland</b>				
	2 prises blanches connectées à un connecteur noir et 2 prises rouges connectées à un connecteur blanc	UG45FRWI-W2R2	C45	1408	74,11/pc.

# Boîtes d'appareillage et plaques de recouvrement

	type	référence	page catal.	groupe d'articles	prix en €	
	<b>Supports pour platines (3x UDEP)</b>					
	Acier galvanisé Sendzimir	UGETD	UGETD-3 226	D15	1408	24,33/pc.
			UGETD-UZ	D15	1408	11,84/pc.
	<b>Technique lumière</b>					
	Aluminium	UDEP	UDEP-SCD 4	D16	1408	4,28/pc.
	<b>Technique lumière</b>					
	Aluminium	UDEP	UDEP-SCS 4	D16	1408	4,28/pc.
	<b>Technique de données</b>					
	Aluminium	UDEP	UDEP-BTR 3	D17	1408	4,28/pc.
	<b>Technique de données</b>					
	Aluminium	UDEP	UDEP-COR 3	D17	1408	4,28/pc.
	<b>Technique de données</b>					
	Aluminium	UDEP	UDEP-HAR PL3	D17	1408	4,28/pc.
	<b>Technique de données</b>					
	Aluminium	UDEP	UDEP-AMP 3	D17	1408	4,28/pc.
	<b>Technique de données</b>					
	Aluminium	UDEP	UDEP-AMP SL3	D17	1408	4,28/pc.

# Boîtes d'appareillage et plaques de recouvrement







	type	référence	page catal.	groupe d'articles	prix en €
	<b>Technique de données</b>				
Aluminium	UDEP	UDEP-GG45 3	D17	1408	4,28/pc.
	<b>Technique de données</b>				
Aluminium	UDEP	UDEP-LEX 2	D17	1408	4,28/pc.
	<b>Technique de données</b>				
Aluminium	UDEP	UDEP-KR 2	D18	1408	4,28/pc.
	<b>Technique de données</b>				
Aluminium	UDEP	UDEP-RM 2	D18	1408	4,28/pc.
	<b>Technique de données</b>				
Aluminium	UDEP	UDEP-RMSC 2	D18	1408	4,28/pc.
	<b>Technique de données</b>				
Aluminium	UDEP	UDEP-RMSC 3	D18	1408	4,28/pc.
	<b>Technique de données</b>				
Aluminium	UDEP	UDEP-KEL 3	D18	1408	10,18/pc.
	<b>Technique de données</b>				
Aluminium	UDEP	UDEP-SYS 2	D18	1408	4,28/pc.

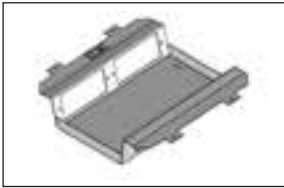

# Boîtes d'appareillage et plaques de recouvrement

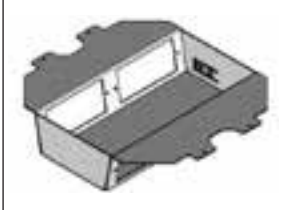
	type	référence	page catal.	groupe d'articles	prix en €
	<b>Platine aveugle</b>				
Aluminium	UDEP	UDEP-B	D18	1408	4,28/pc.
	<b>Technique de connexion</b>				
Aluminium	UDEP	UDEP-5PK 1	D19	1408	4,28/pc.
	<b>Technique de connexion</b>				
Aluminium	UDEP	UDEP-5PCOM 1	D19	1408	4,28/pc.
	<b>Technique de connexion</b>				
Aluminium	UDEP	UDEP-3PK 2	D19	1408	4,28/pc.
	<b>Technique audio et vidéo</b>				
Aluminium	UDEP	UDEP-KM 1	D16	1408	4,88/pc.
	<b>Technique audio et vidéo</b>				
Aluminium	UDEP	UDEP-XLR 2	D19	1408	4,52/pc.
	<b>Technique audio et vidéo</b>				
Aluminium	UDEP	UDEP-DSUB9 1	D16	1408	4,52/pc.

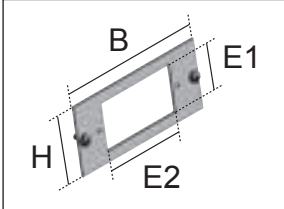
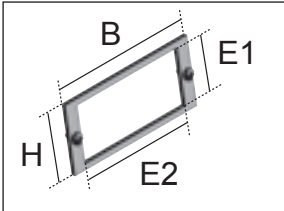
# Boîtes d'appareillage et plaques de recouvrement

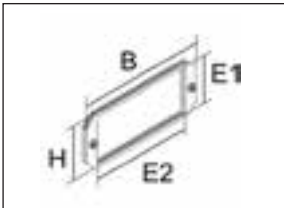
	type	référence	page catal.	groupe d'articles	prix en €
	<b>Cadre d'appareillage pour boîte de sol carrée en polyamide</b>				
Acier galvanisé Sendzimir	UGE	UGE3-VK 8UST	D24	1408	47,11/pc.
	<b>Cadre d'appareillage pour boîte de sol ronde en polyamide</b>				
Acier galvanisé Sendzimir	UGE	UGE3-RK 8UST	D24	1408	50,32/pc.
	<b>Cadre d'appareillage pour cassette de nivellement ronde</b>				
Acier galvanisé Sendzimir	UGE	UGE3-RE 8UST	D25	1408	41,64/pc.
	<b>Cadre d'appareillage pour unité de nivellement UNE</b>				
Acier galvanisé Sendzimir	UGE	UGE3-VE 8UST	D25	1408	61,20/pc.
	<b>Technique de données</b>				
Acier galvanisé Sendzimir	UGEE	UGEE-1-DEP		1408	6,30/pc.
	<b>Modules 45x45</b>				
Acier galvanisé Sendzimir	UGEE	UGEE-2-UST45	D26	1408	5,66/pc.
	<b>Cadre d'appareillage pour boîte de sol carrée en matière synthétique, sortie avec brosse</b>				
Acier galvanisé Sendzimir	UGE	UGE3-60K 4		1408	60,98/pc.
	<b>Modules 45x45</b>				
Acier galvanisé Sendzimir	UGE	UGEE3-2-UST45		1408	6,65/pc.



# Gaines murales et canaux d'alimentation

Avec les gaines murales et canaux d'alimentation DUCTEL, le câblage électrique et les câbles de données et de télécommunication sont guidés via le mur vers les différents postes de travail afin d'ainsi pourvoir ces postes de prises de courant et de points de raccordement multimédia rapidement accessibles.

Les canaux d'alimentation DUCTEL ne sont utilisés que pour le passage des câbles alors que les gaines murales DUCTEL offrent la possibilité d'intégrer des prises de courant (traditionnelles ou 45x45 mm).



DUCTEL est disponible en blanc laqué ou en version naturelle anodisée et, sur demande, également disponible dans les autres couleurs RAL. Le système de gaines murales et les couvercles assortis sont toujours livrés avec un feuil de protection.



La pièce d'angle DUCTEL est utilisable comme angle intérieur ou angle extérieur. La pièce d'angle glisse sur la longueur de la gaine et est disponible en blanc et en version anodisée.



Tant les prises traditionnelles que les prises du type de 45 mm peuvent être installées. Ces dernières s'encliquettent directement dans l'ouverture du couvercle, sans outils.



L'embout est fixé sur la gaine par encliquetage sans vis ni outils. Une telle installation simplifiée offre à la fois une économie de coûts, d'effort et de temps.



Le système de gaines murales DUCTEL peut être fixé directement contre la paroi ou par l'intermédiaire de supports muraux. Des parois inégales peuvent être compensées par des pièces ajustables. L'ouverture derrière les gaines murales peut être couverte d'une plaque de couverture.



Des gaines d'alimentation sont utilisées pour le guidage de câbles dans les installations sans prises de courant. Les gaines d'alimentation plus grandes sont idéales pour amener des câbles vers des gaines murales horizontales (page 169-170).





Les nouvelles pièces d'accouplement sont conçues spécialement pour le système DUCTEL et assurent un accouplement parfait de toutes les longueurs.





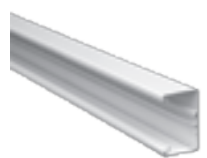
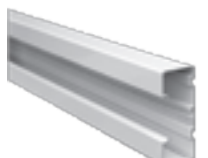

Le collier DUCTEL facilite le façonnage de dérivations verticales. Montage rapide et peu coûteux.

## Gaines murales DUCTEL pour mécanismes avec anneau de fixation





	<b>TB1010 PK1010</b>	<b>TB1310 PK1310</b>	<b>TB1710</b>	<b>TB2210</b>	<b>TB1032-2</b>
					
<b>Montage</b>	<b>APPARENT</b>				<b>ENCASTRÉ</b>
<b>Dimensions mm</b>	100x65x3000	135x65x3000	170x65x3000	220x65x3000	125/100x65x3000
<b>Nombre de couvercles 80 mm</b>	1	1	1	2	1
<b>Version</b>					
* aluminium anodisé	page 163	page 166	page 169	page 171	/
* aluminium blanc laqué	page 163	page 166	page 169	page 171	<b>N</b> page 175
* matière synthétique, blanc	<b>N</b> page 164	<b>N</b> page 167	/	/	/

### Gaines murales DUCTEL pour modules 45x45

### Gaines murales DUCTEL pour modules 45x45 + mécanismes avec anneau de fixation

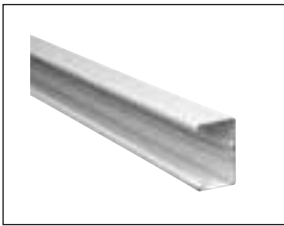
	<b>TB1040</b>	<b>TB1340</b>		<b>TB1740</b>	<b>TB2240</b>
					
<b>Montage</b>	<b>APPARENT</b>		<b>Montage</b>	<b>APPARENT</b>	
<b>Dimensions mm</b>	100x65x3000	135x65x3000	<b>Dimensions mm</b>	170x65x3000	220x65x3000
<b>Nombre de couvercles 45 mm</b>	1	2	<b>Nombre de couvercles 45/80 mm</b>	1x45 1x80	2x45 1x80
<b>Version</b>			<b>Version</b>		
* aluminium anodisé	page 165	page 168	* aluminium anodisé	page 170	page 172
* aluminium blanc laqué	page 165	page 168	* aluminium blanc laqué	page 170	page 172

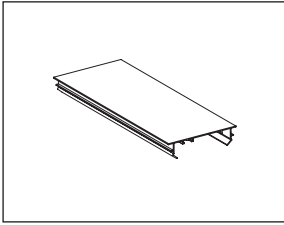

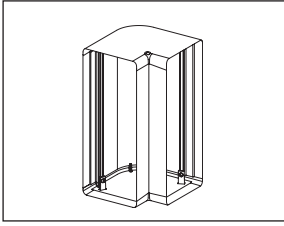
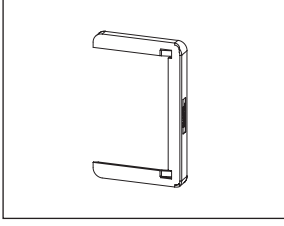
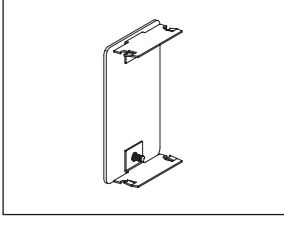
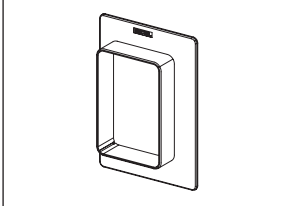

# Système de gaines murales Ductel

	type	référence	page catal.	groupe d'articles	prix en €
	<b>Base 100x65</b>				
	Aluminium	anodisé blanc laqué	TB1010-1 TB1010-3	8 8	2601 2601
					
Couvercle à commander séparément.					
	<b>Couvercle 80x19</b>				
	Aluminium	anodisé blanc laqué	TB80-1 TB80-3	8 8	2601 2601
					
	<b>Pièce d'angle 103x90x90</b>				
	Aluminium/matière synthétique	anodisé/gris blanc laqué/blanc	TBC100-1 TBC100-3	8 8	2601 2601
	<b>Collier 105x67x12</b>				
	Matière synthétique	gris blanc	TBL10-1 TBL10-3	8 8	2601 2601
	<b>Embout 100x65x24</b>				
	Aluminium	anodisé blanc laqué	TBP100-1 TBP100-3	8 8	2601 2601
	<b>Plaque de finition 151x106x25</b>				
	Matière synthétique	blanc	TBO100-3	8	2601

# Systeme de gaines murales Ductel

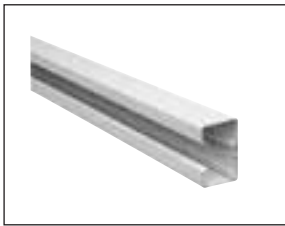
	type	référence	page catal.	groupe d'articles	prix en €
	<b>Base 100x65</b>				
	Matière synthétique  Couverture inclus.	blanc	PK1010-3	2601	24,42/m
	<b>Couverture</b>				
	Matière synthétique	blanc	PDC100-3	2601	4,45/pc.
	<b>Pièce d'angle 103x90x90</b>				
	Aluminium/matière synthétique	blanc laqué/blanc	TBC100-3	9	2601
	<b>Collier 105x67x12</b>				
	Matière synthétique	blanc	TBL10-3	9	2601
	<b>Embout 100x65x24</b>				
	Matière synthétique	blanc	PKE100-3	2601	5,11/pc.
	<b>Plaque de finition 151x106x25</b>				
	Matière synthétique	blanc	TBO100-3	9	2601
	<b>Accouplement</b>				
	Matière synthétique	blanc	PKJ1	2601	1,78/pc.

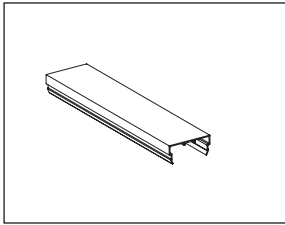
# Systeme de gaines murales Ductel

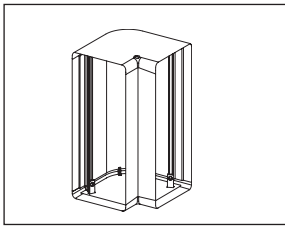
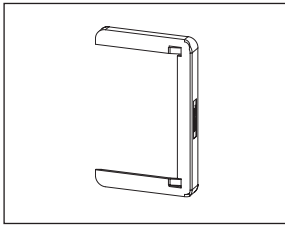
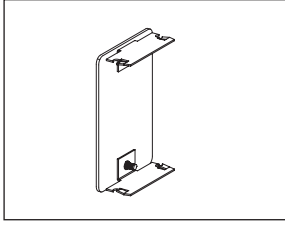
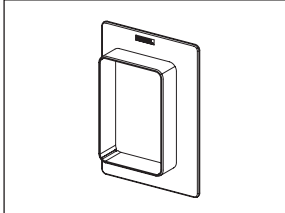



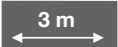
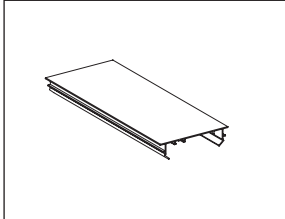
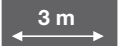
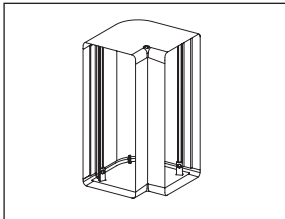
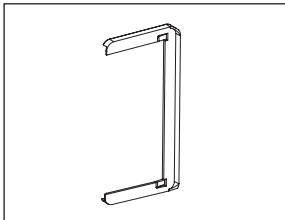
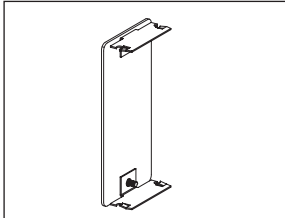
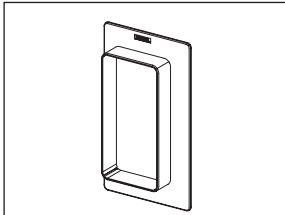

	type	référence	page catal.	groupe d'articles	prix en €
	<b>Base 100x65</b>				
	Aluminium				
	anodisé	TB1040-1	9	2601	53,90/m
	blanc laqué	TB1040-3	9	2601	53,90/m
	Couvercle à commander séparément.				
	<b>Couvercle 45x19</b>				
	Aluminium				
	anodisé	TB45-1	9	2601	11,19/m
	blanc laqué	TB45-3	9	2601	11,19/m
	<b>Pièce d'angle 103x90x90</b>				
	Aluminium/matière synthétique				
	anodisé/gris	TBC100-1	9	2601	38,34/pc.
	blanc laqué/blanc	TBC100-3	9	2601	38,34/pc.
	<b>Collier 105x67x12</b>				
	Matière synthétique				
	gris	TBL10-1	9	2601	7,79/pc.
	blanc	TBL10-3	9	2601	7,79/pc.
	<b>Embout 100x65x24</b>				
	Aluminium				
	anodisé	TBP100-1	9	2601	12,76/pc.
	blanc laqué	TBP100-3	9	2601	12,76/pc.
	<b>Plaque de finition 151x106x25</b>				
	Matière synthétique				
	blanc	TBO100-3	9	2601	8,54/pc.

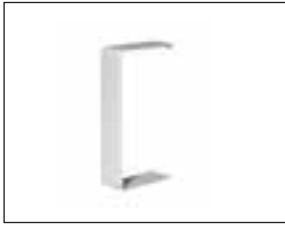
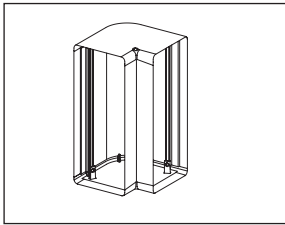
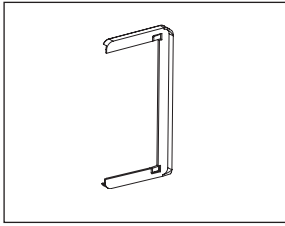

# Systeme de gaines murales Ductel

	type	référence	page catal.	groupe d'articles	prix en €
	<b>Base 135x65</b>				
	Aluminium				
	anodisé	TB1310-1	10	2601	51,48/m
	blanc laqué	TB1310-3	10	2601	51,48/m
	Couvercle à commander séparément.				
	<b>Couvercle 80x19</b>				
	Aluminium				
	anodisé	TB80-1	10	2601	15,68/m
	blanc laqué	TB80-3	10	2601	15,68/m
	<b>Pièce d'angle 138x90x90</b>				
	Aluminium/matière synthétique				
	anodisé/gris	TBC135-1	10	2601	38,34/pc.
	blanc laqué/blanc	TBC135-3	10	2601	38,34/pc.
	<b>Collier 140x67x12</b>				
	Matière synthétique				
	gris	TBL13-1	10	2601	7,79/pc.
	blanc	TBL13-3	10	2601	7,79/pc.
	<b>Embout 135x65x24</b>				
	Aluminium				
	anodisé	TBP135-1	10	2601	13,68/pc.
	blanc laqué	TBP135-3	10	2601	13,68/pc.
	<b>Plaque de finition 186x106x25</b>				
	Matière synthétique				
	blanc	TBO135-3	10	2601	9,08/pc.

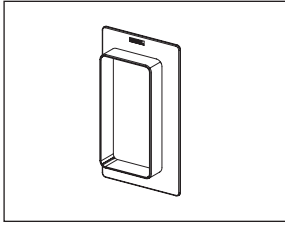

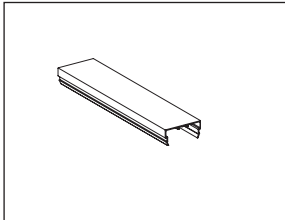
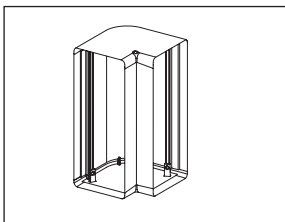
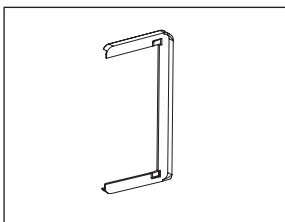
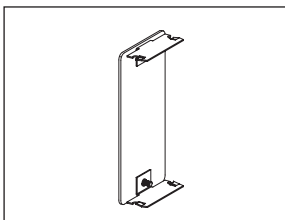
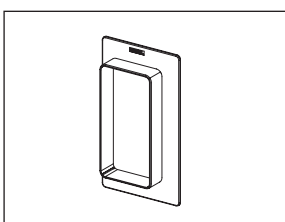

# Système de gaines murales Ductel

	type	référence	page catal.	groupe d'articles	prix en €
	<b>Base 135x65</b>				
	Matière synthétique	blanc	PK1310-3	2601	31,82/m
					
Couvercle inclus.					
	<b>Couverture</b>				
	Matière synthétique	blanc	PDC135-3	2601	4,72/pc.
	<b>Pièce d'angle 138x90x90</b>				
	Aluminium/matière synthétique	blanc laqué/blanc	TBC135-3	10	2601
	<b>Collier 140x67x12</b>				
	Matière synthétique	blanc	TBL13-3	10	2601
	<b>Embout 135x65x24</b>				
	Matière synthétique	blanc	PKE135-3	2601	5,36/pc.
	<b>Plaque de finition 186x106x25</b>				
	Matière synthétique	blanc	TBO135-3	10	2601
	<b>Accouplement</b>				
	Matière synthétique	blanc	PKJ1	2601	1,78/pc.

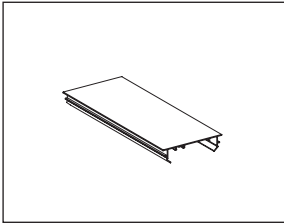

# Systeme de gaines murales Ductel

	type	référence	page catal.	groupe d'articles	prix en €
	<b>Base 135x65</b>				
	Aluminium				
	anodisé	TB1340-1	11	2601	57,09/m
	blanc laqué	TB1340-3	11	2601	57,09/m
	Couvercle à commander séparément.				
	<b>Couvercle 45x19</b>				
	Aluminium				
	anodisé	TB45-1	11	2601	11,19/m
	blanc laqué	TB45-3	11	2601	11,19/m
	<b>Pièce d'angle 138x90x90</b>				
	Aluminium/matière synthétique				
	anodisé/gris	TBC135-1	11	2601	38,34/pc.
	blanc laqué/blanc	TBC135-3	11	2601	38,34/pc.
	<b>Collier 140x67x12</b>				
	Matière synthétique				
	gris	TBL13-1	11	2601	7,79/pc.
	blanc	TBL13-3	11	2601	7,79/pc.
	<b>Embout 135x65x24</b>				
	Aluminium				
	anodisé	TBP135-1	11	2601	13,68/pc.
	blanc laqué	TBP135-3	11	2601	13,68/pc.
	<b>Plaque de finition 186x106x25</b>				
	Matière synthétique				
	blanc	TBO135-3	11	2601	9,08/pc.

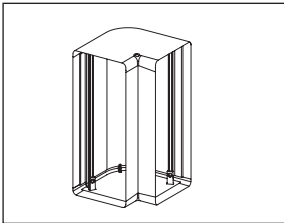
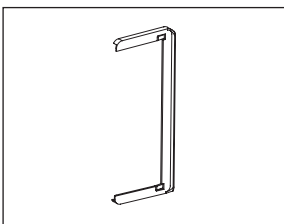
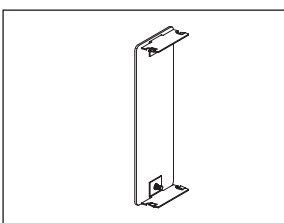
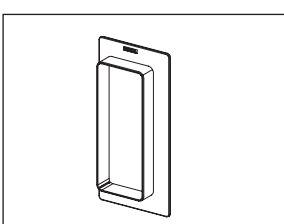
# Systeme de gaines murales Ductel

	type	référence	page catal.	groupe d'articles	prix en €
	<b>Base 170x65</b>				
	Aluminium				
	anodisé	TB1710-1	12	2601	65,26/m
	blanc laqué	TB1710-3	12	2601	65,26/m
	Couvercle à commander séparément.				
	<b>Couvercle 80x19</b>				
	Aluminium				
	anodisé	TB80-1	12	2601	15,68/m
	blanc laqué	TB80-3	12	2601	15,68/m
	<b>Pièce d'angle 173x90x90</b>				
	Aluminium/matière synthétique				
	anodisé/gris	TBC170-1	12	2601	40,66/pc.
	blanc laqué/blanc	TBC170-3	12	2601	40,66/pc.
	<b>Collier 175x67x12</b>				
	Matière synthétique				
	gris	TBL17-1	12	2601	7,79/pc.
	blanc	TBL17-3	12	2601	7,79/pc.
	<b>Embout 170x65x24</b>				
	Aluminium				
	anodisé	TBP170-1	12	2601	15,47/pc.
	blanc laqué	TBP170-3	12	2601	15,47/pc.
	<b>Plaque de finition 221x106x25</b>				
	Matière synthétique				
	blanc	TBO170-3	12	2601	9,36/pc.

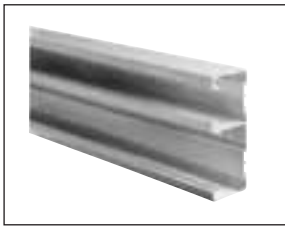

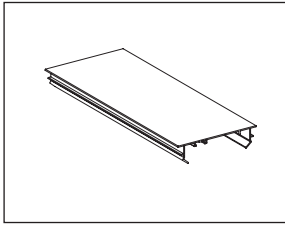
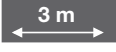
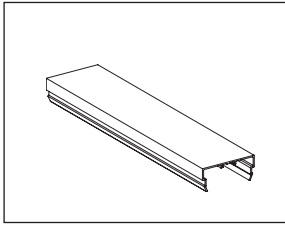
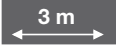
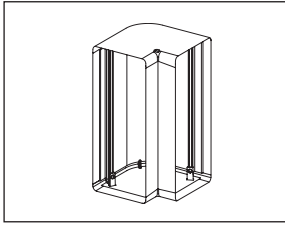
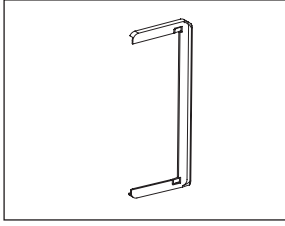
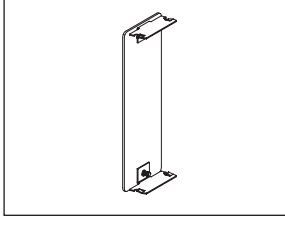
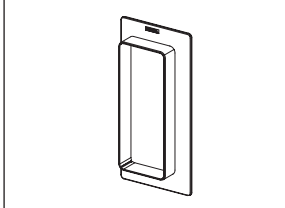

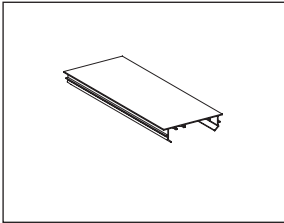
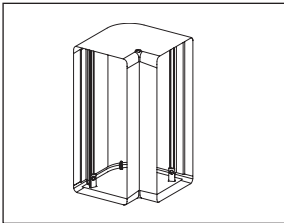
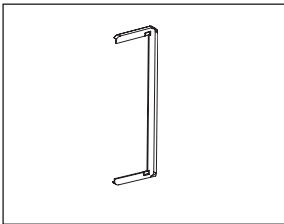
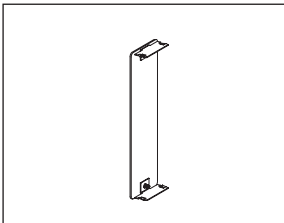
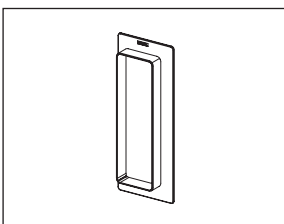

# Systeme de gaines murales Ductel

	type	référence	page catal.	groupe d'articles	prix en €
	<b>Base 170x65</b>				
	Aluminium				
	anodisé	TB1740-1	13	2601	66,56/m
	blanc laqué	TB1740-3	13	2601	66,56/m
	Couvercle à commander séparément.				
	<b>Couvercle 80x19</b>				
	Aluminium				
	anodisé	TB80-1	13	2601	15,68/m
	blanc laqué	TB80-3	13	2601	15,68/m
	<b>Couvercle 45x19</b>				
	Aluminium				
	anodisé	TB45-1	13	2601	11,19/m
	blanc laqué	TB45-3	13	2601	11,19/m
	<b>Pièce d'angle 173x90x90</b>				
	Aluminium/matière synthétique				
	anodisé/gris	TBC170-1	13	2601	40,66/pc.
	blanc laqué/blanc	TBC170-3	13	2601	40,66/pc.
	<b>Collier 175x67x12</b>				
	Matière synthétique				
	gris	TBL17-1	13	2601	7,79/pc.
	blanc	TBL17-3	13	2601	7,79/pc.
	<b>Embout 170x65x24</b>				
	Aluminium				
	anodisé	TBP170-1	13	2601	15,47/pc.
	blanc laqué	TBP170-3	13	2601	15,47/pc.
	<b>Plaque de finition 221x106x25</b>				
	Matière synthétique				
	blanc	TBO170-3	13	2601	9,36/pc.

# Systeme de gaines murales Ductel

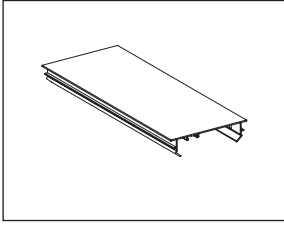

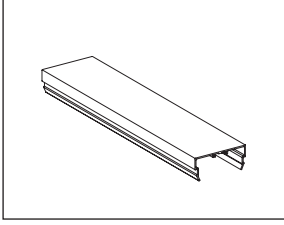
	type	référence	page catal.	groupe d'articles	prix en €
	<b>Base 220x65</b>				
	Aluminium				
	<div style="background-color: #333; color: white; padding: 2px; display: inline-block;">3 m</div>	anodisé	TB2210-1	14	2601
	blanc laqué	TB2210-3	14	2601	88,03/m
Couvercle à commander séparément.					
	<b>Couvercle 80x19</b>				
	Aluminium				
	<div style="background-color: #333; color: white; padding: 2px; display: inline-block;">3 m</div>	anodisé	TB80-1	14	2601
	blanc laqué	TB80-3	14	2601	15,68/m
	<b>Pièce d'angle 223x90x90</b>				
	Aluminium/matière synthétique				
		anodisé/gris	TBC220-1	14	2601
	blanc laqué/blanc	TBC220-3	14	2601	43,09/pc.
	<b>Collier 225x67x12</b>				
	Matière synthétique				
		gris	TBL22-1	14	2601
	blanc	TBL22-3	14	2601	7,79/pc.
	<b>Embout 220x65x24</b>				
	Aluminium				
		anodisé	TBP220-1	14	2601
	blanc laqué	TBP220-3	14	2601	17,04/pc.
	<b>Plaque de finition 271x106x25</b>				
	Matière synthétique				
		blanc	TBO220-3	14	2601

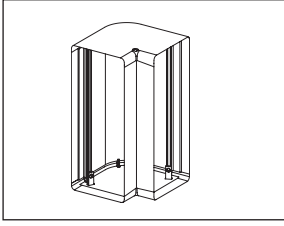
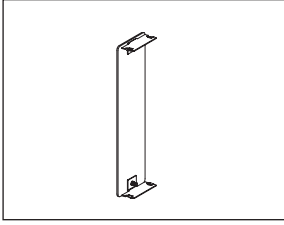
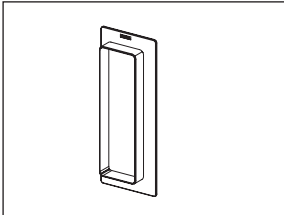
# Systeme de gaines murales Ductel





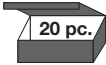
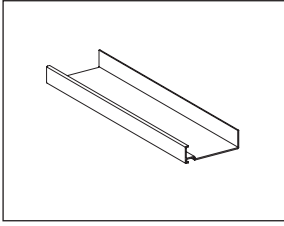
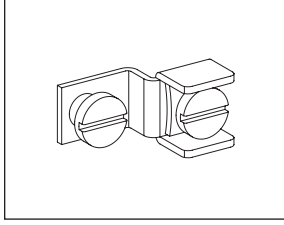
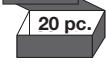
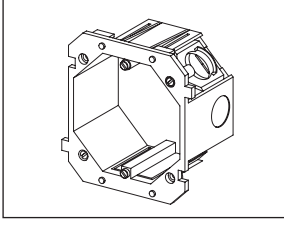

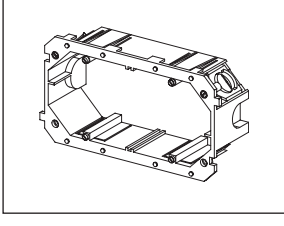
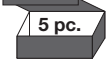
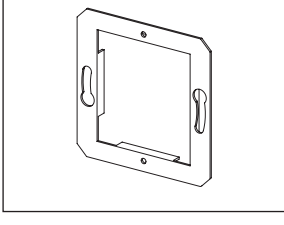
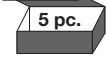
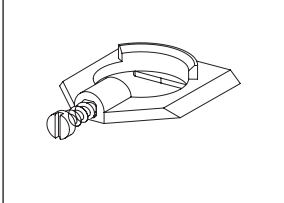
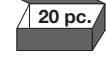

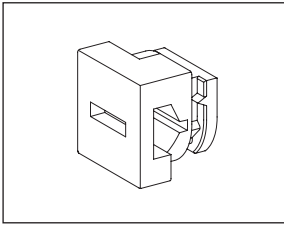

	type	référence	page catal.	groupe d'articles	prix en €
	<b>Base 220x65</b>				
	Aluminium				
	anodisé	TB2240-1		2601	109,54/m
	blanc laqué	TB2240-3		2601	109,54/m
Couvercle à commander séparément.					
	<b>Couvercle 80x19</b>				
	Aluminium				
	anodisé	TB80-1		2601	15,68/m
	blanc laqué	TB80-3		2601	15,68/m
	<b>Couvercle 45x19</b>				
	Aluminium				
	anodisé	TB45-1		2601	11,19/m
	blanc laqué	TB45-3		2601	11,19/m
	<b>Pièce d'angle 223x90x90</b>				
	Aluminium/matière synthétique				
	anodisé/gris	TBC220-1		2601	43,09/pc.
	blanc laqué/blanc	TBC220-3		2601	43,09/pc.
	<b>Collier 225x67x12</b>				
	Matière synthétique				
	gris	TBL22-1		2601	7,79/pc.
	blanc	TBL22-3		2601	7,79/pc.
	<b>Embout 220x65x24</b>				
	Aluminium				
	anodisé	TBP220-1		2601	17,04/pc.
	blanc laqué	TBP220-3		2601	17,04/pc.
	<b>Plaque de finition 271x106x25</b>				
	Matière synthétique				
	blanc	TBO220-3		2601	9,74/pc.

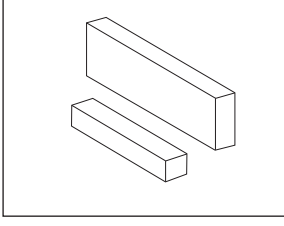
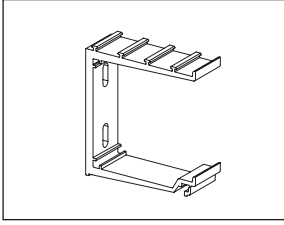

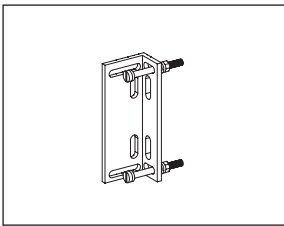
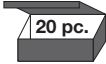
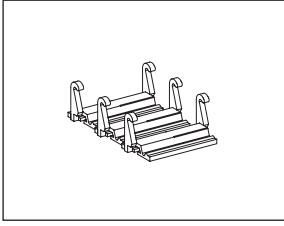
# Systeme de gaines murales Ductel

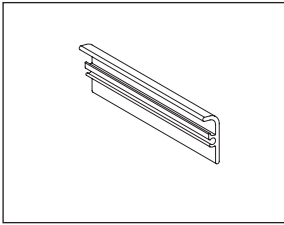
	type	référence	page catal.	groupe d'articles	prix en €
	<b>Accouplement 12x53x70</b> Aluminium	TBJ1	15	2601	4,44/pc.
	 Uniquement pour gaines murales en aluminium.				
	<b>Cloison de séparation 15x52</b> Aluminium	TDH1	15	2601	10,81/m
					
	<b>Borne de mise à la terre</b> Acier	TBM1	16	2601	6,75/pc.
					
	<b>Boîte d'encastrement 79x42,5x79</b> Matière synthétique	TBF1	17	2601	5,84/pc.
	bleu 				
	<b>Boîte d'encastrement 79x42,5x150</b> Matière synthétique	TBF2	17	2601	13,24/pc.
	bleu 				
	<b>Anneau de montage 70x70x5</b> Acier	TBF12	17	2601	14,38/pc.
					
	<b>Serre-câbles</b> Matière synthétique	TBF11	17	2601	1,35/pc.
	noir 				

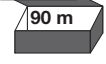
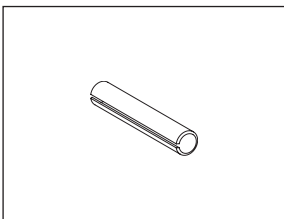
# Systeme de gaines murales Ductel

	type	référence	page catal.	groupe d'articles	prix en €	
	<b>Clame de fixation</b>					
	Matière synthétique	TBK1	16	2601	1,46/pc.	
						
	<b>Bande d'isolation</b>					
	Matière synthétique	32x30x300	XTBO304	16	2601	8,87/pc.
		74x30x300	XTBO308	16	2601	15,25/pc.
	<b>Etrier mural</b>					
	Aluminium					
		25	TBE25	15	2601	6,32/pc.
		50	TBE50	15	2601	7,57/pc.
		75	TBE75	15	2601	9,74/pc.
		100	TBE100	15	2601	12,05/pc.
	125	TBE125	15	2601	14,66/pc.	
						
	<b>Plaque d'ajustage</b>					
	Aluminium	TBE1	15	2601	9,62/pc.	
						
	<b>Clip de fixation pour ailettes de ventilation 73x40</b>					
	Matière synthétique	TBE3	16	2601	3,14/pc.	
						
	<b>Ailettes de ventilation 24x9</b>					
	Aluminium					
		anodisé	TBE20-1	17	2601	10,55/m
		blanc laqué	TBE20-3	17	2601	10,55/m
						
						
	<b>Accouplement 3x18</b>					
	Acier	TBJ8	17	2601	0,48/pc.	
						

# Gaine murale encastrée et canaux d'alimentation Ductel

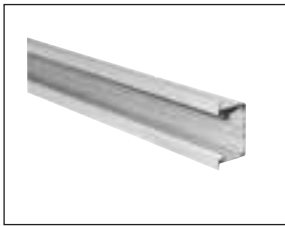
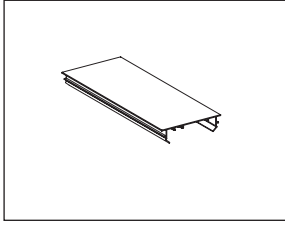
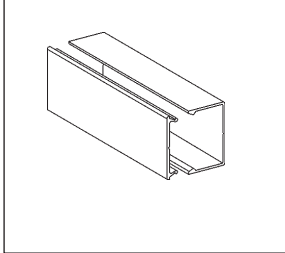
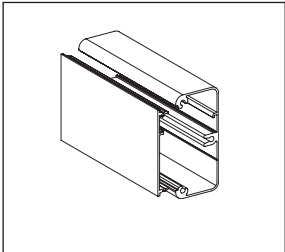
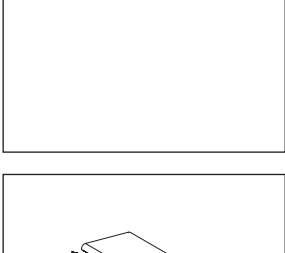
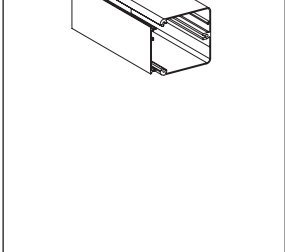
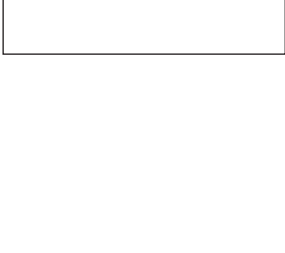
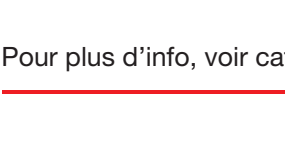
	type	référence	page catal.	groupe d'articles	prix en €
	<b>Base 125/100x65</b>				
	Aluminium blanc laqué	TB1032-3		2601	56,86/m
	<div style="background-color: #333; color: white; padding: 2px; display: inline-block;">3 m</div> Couverture à commander séparément.				
	<b>Couvercle 80x19</b>				
	Aluminium blanc laqué	TB80-3		2601	15,68/m
	<div style="background-color: #333; color: white; padding: 2px; display: inline-block;">3 m</div>				
	<b>Base 30x20,5</b>				
	Aluminium	anodisé	TBA202-1	2602	16,00/m
		blanc laqué	TBA202-3	2602	16,00/m
	<div style="background-color: #333; color: white; padding: 2px; display: inline-block;">3 m</div>				
	<b>Couvercle 32x6</b>				
	Aluminium	anodisé	TBA22-1	2602	10,81/m
		blanc laqué	TBA22-3	2602	10,81/m
	<div style="background-color: #333; color: white; padding: 2px; display: inline-block;">3 m</div>				
	<b>Base 65x30</b>				
	Aluminium	anodisé	TBA302-1	21	2602
		blanc laqué	TBA302-3	21	2602
	<div style="background-color: #333; color: white; padding: 2px; display: inline-block;">3 m</div>				
	<b>Couvercle 54x7,5</b>				
	Aluminium	anodisé	TBA32-1	21	2602
		blanc laqué	TBA32-3	21	2602
	<div style="background-color: #333; color: white; padding: 2px; display: inline-block;">3 m</div>				
	<b>Embout 65x30</b>				
	Aluminium	anodisé	TBD30-1	21	2602
		blanc laqué	TBD30-3	21	2602
	<div style="background-color: #333; color: white; padding: 2px; display: inline-block;">3 m</div>				
	<b>Base 65x65</b>				
	Aluminium	anodisé	TBA652-1	21	2602
		blanc laqué	TBA652-3	21	2602
	<div style="background-color: #333; color: white; padding: 2px; display: inline-block;">3 m</div>				
	<b>Couvercle 54x7,5</b>				
	Aluminium	anodisé	TBA32-1	21	2602
		blanc laqué	TBA32-3	21	2602
	<div style="background-color: #333; color: white; padding: 2px; display: inline-block;">3 m</div>				
	<b>Embout 65x65</b>				
	Aluminium	anodisé	TBD65-1	21	2602
		blanc laqué	TBD65-3	21	2602
	<div style="background-color: #333; color: white; padding: 2px; display: inline-block;">3 m</div>				

# Gaines d'alimentation Ductel

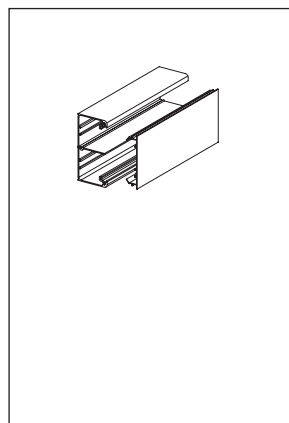

## Base 100x49

Aluminium



anodisé  
blanc laqué

TBA10-1  
TBA10-3

21  
21

2602  
2602

55,69/m  
55,69/m

## Couvercle 80x19

Aluminium

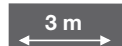

anodisé  
blanc laqué

TB80-1  
TB80-3

21  
21

2601  
2601

15,68/m  
15,68/m

## Embout 100x49

Aluminium

anodisé  
blanc laqué

TBD100-1  
TBD100-3

21  
21

2602  
2602

11,03/pc.  
11,03/pc.

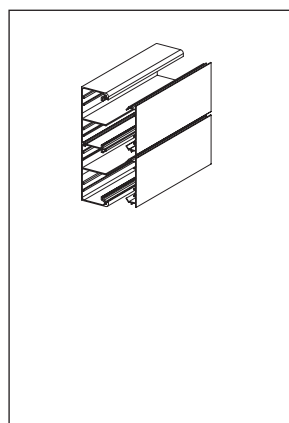

## Base 184x49

Aluminium



anodisé  
blanc laqué

TBA18-1  
TBA18-3

21  
21

2602  
2602

98,13/m  
98,13/m

## Couvercle 80x19

Aluminium



anodisé  
blanc laqué

TB80-1  
TB80-3

21  
21

2601  
2601

15,68/m  
15,68/m

## Embout 184x49

Aluminium

anodisé  
blanc laqué

TBD180-1  
TBD180-3

21  
21

2602  
2602

12,49/pc.  
12,49/pc.



## Canalisations à câbles en matière synthétique

Les gaines murales et canaux d'alimentation en matière synthétique conduisent le câblage de courant, de données et de télécommunication via la paroi vers les différents endroits afin de les pourvoir simplement de prises de courant et de points de connexion multimédia à accès aisé.

### Canaux d'alimentation



avec encoche  
page 198



avec couvercle à charnière  
page 196



anguleux  
page 199-202



élégant  
sur demande



canal d'alimentation  
page 202-203

### Canaux de sol – Canaux de coin – Canaux de plinthe



canal de sol arrondi  
page 197



canal de coin  
triangulaire page 196



canal de plinthe  
page 194



canal de plinthe  
page 193

### Gainés murales



pour montage à  
anneau standard  
page 182-185



pour modules 45 x 45  
page 179-181

### Goulottes de câblage



goulotte de câblage  
page 204





# Canalisations à câbles en matière synthétique exemptes d'halogènes

La version des gaines murales et canaux d'alimentation exempts d'halogènes est requise dans les bâtiments publics comme les hôpitaux, les écoles, les musées, les centres d'aide sociale, ...

Grâce à leur composition chimique spécifique, les gaines à câbles exemptes d'halogènes KOPOS émettent, en cas d'incendie, moins de gaz nuisibles, qui – en combinaison avec des produits extincteurs – peuvent produire des gaz toxiques. Donc, en cas d'incendie, la sécurité des personnes encore présentes dans le bâtiment et des services d'urgence est considérablement augmentée. Ainsi, les blessures corporelles et les dommages peuvent être limités au minimum.

## Canaux d'alimentation type LHD – exempts d'halogènes



LHD20x10HF  
page 199



LHD20x20HF  
page 200



LHD40x20HF  
page 201



LHD40x40HF  
page 202



EKD80x40HF  
page 203

## Canal d'alimentation EKD exempt d'halogènes

## Gainés murales – exemptes d'halogènes



PK110x70DHF  
pour montage à  
anneau standard  
page 183











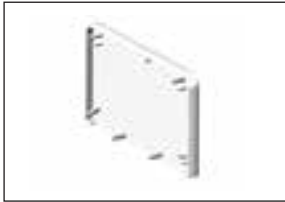
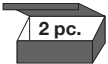
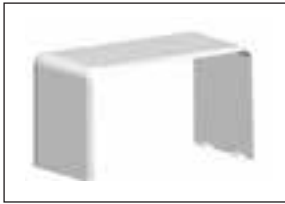
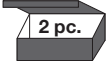

PK90x55DHF  
pour modules 45 x 45  
page 197

## Goulottes de câblage – exemptes d'halogènes

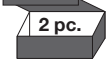
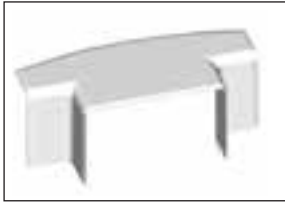
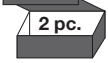

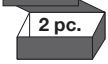

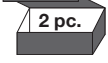

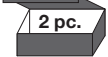





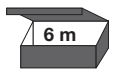
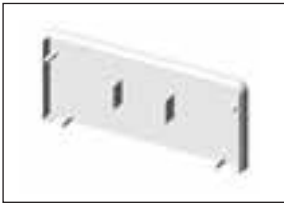
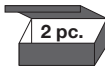
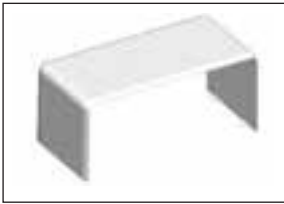
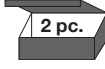

RK...X...HF  
page 204

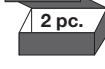
# Systemes de gaines murales PK

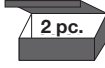
	type	référence	page catal.	groupe d'articles	prix en €	
	<b>Base + couvercle PK 90x55 D</b>					
	Matière synthétique	blanc	KPK90X55DHD	43	2501	15,38/m
	Matière synthétique exempte d'halogènes	blanc	KPK90X55DHFHD	55	2501	41,51/m
						
	<b>Embout PK 90x55 D</b>					
	Matière synthétique	blanc	K8401HB	43	2506	7,09/pc.
	Matière synthétique exempte d'halogènes	blanc	K8401HFHB	55	2506	9,92/pc.
						
	<b>Accouplement PK 90x55 D</b>					
	Matière synthétique	blanc	K8402HB	43	2506	7,09/pc.
	Matière synthétique exempte d'halogènes	blanc	K8402HFHB	55	2506	9,92/pc.
						
	<b>Angle plat PK 90x55 D</b>					
	Matière synthétique	blanc	K8403HB	43	2506	14,15/pc.
	Matière synthétique exempte d'halogènes	blanc	K8403HFHB	55	2506	17,46/pc.
						
	<b>Pièce en T PK 90x55 D</b>					
	Matière synthétique	blanc	K8404HB	43	2506	14,15/pc.
	Matière synthétique exempte d'halogènes	blanc	K8404HFHB	55	2506	17,46/pc.
						
	<b>Angle intérieur PK 90x55 D</b>					
	Matière synthétique	blanc	K8405HB	43	2506	14,15/pc.
	Matière synthétique exempte d'halogènes	blanc	K8405HFHB	55	2506	17,46/pc.
						
	<b>Angle extérieur PK 90x55 D</b>					
	Matière synthétique	blanc	K8406HB	43	2506	14,15/pc.
	Matière synthétique exempte d'halogènes	blanc	K8406HFHB	55	2506	17,46/pc.
						
	<b>Plaque de finition PK 90x55 D</b>					
	Matière synthétique	blanc	K8407HB	43	2506	5,58/pc.
	Matière synthétique exempte d'halogènes	blanc	K8407HFHB	55	2506	9,92/pc.
						

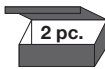

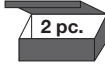

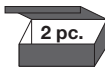



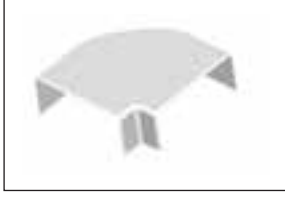
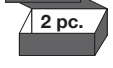



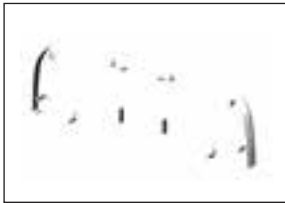
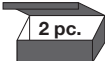

# Systemes de gaines murales PK

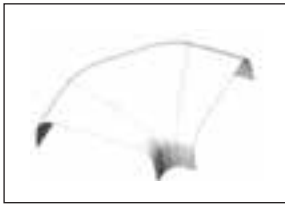
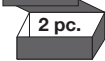
	type	réf�rence	page catal.	groupe d'articles	prix en �	
	<b>Base + couvercle PK 120x55 D</b>					
	Mati�re synth�tique	blanc	KPK120X55DHD	44	2501	26,58/m
	 					
	<b>Embout PK 120x55 D</b>					
	Mati�re synth�tique	blanc	K8471HB	44	2506	11,03/pc.
						
	<b>Accouplement PK 120x55 D</b>					
	Mati�re synth�tique	blanc	K8472HB	44	2506	11,03/pc.
						
	<b>Angle plat PK 120x55 D</b>					
	Mati�re synth�tique	blanc	K8473HB	44	2506	19,42/pc.
						
	<b>Pi�ce en T PK 120x55 D</b>					
	Mati�re synth�tique	blanc	K8474HB	44	2506	19,42/pc.
						
	<b>Angle int�rieur PK 120x55 D</b>					
	Mati�re synth�tique	blanc	K8475HB	44	2506	19,42/pc.
						
	<b>Angle ext�rieur PK 120x55 D</b>					
	Mati�re synth�tique	blanc	K8476HB	44	2506	19,42/pc.
						
	<b>Plaque de finition PK 120x55 D</b>					
	Mati�re synth�tique	blanc	K8477HB	44	2506	7,72/pc.
						

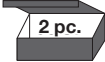

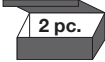

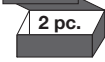

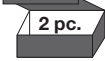

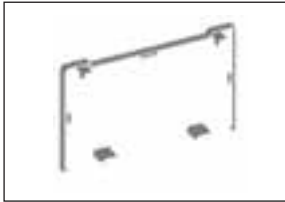
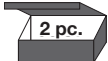
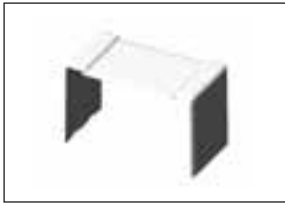
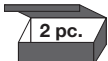

# Systemes de gaines murales PK

	type	référence	page catal.	groupe d'articles	prix en €
	<b>Base + couvercle PK 160x65 D</b>				
	Matière synthétique	blanc	KPK160X65DHD	45	2501
					
	<b>Embout PK 160x65 D</b>				
	Matière synthétique	blanc	K8481HB	45	2506
					
	<b>Accouplement PK 160x65 D</b>				
	Matière synthétique	blanc	K8482HB	45	2506
					
	<b>Angle plat PK 160x65 D</b>				
	Matière synthétique	blanc	K8483HB	45	2506
					
	<b>Pièce en T PK 160x65 D</b>				
	Matière synthétique	blanc	K8484HB	45	2506
					
	<b>Angle intérieur PK 160x65 D</b>				
	Matière synthétique	blanc	K8485HB	45	2506
					
	<b>Angle extérieur PK 160x65 D</b>				
	Matière synthétique	blanc	K8486HB	45	2506
					
	<b>Plaque de finition PK 160x65 D</b>				
	Matière synthétique	blanc	K8487HB	45	2506
					

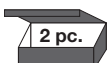
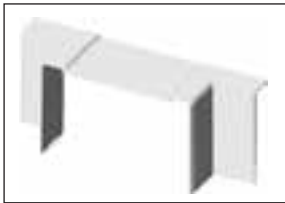
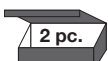

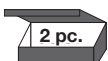

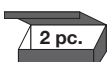



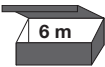
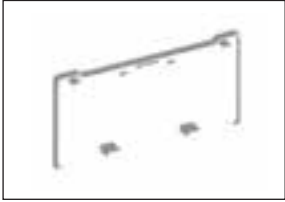
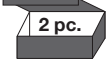
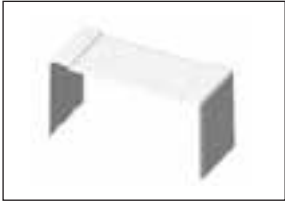
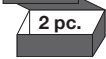

# Systemes de gaines murales PK

	type	réf�rence	page catal.	groupe d'articles	prix en �
	<b>Base + couvercle PK 210x70 D</b>				
	Mati�re synth�tique	blanc	KPK210X70DHD	46	2501
					
	<b>Embout PK 210x70 D</b>				
	Mati�re synth�tique	blanc	K8491HB	46	2506
					
	<b>Accouplement PK 210x70 D</b>				
	Mati�re synth�tique	blanc	K8492HB	46	2506
					
	<b>Angle plat PK 210x70 D</b>				
	Mati�re synth�tique	blanc	K8493HB	46	2506
					
	<b>Pi�ce en T PK 210x70 D</b>				
	Mati�re synth�tique	blanc	K8494HB	46	2506
					
	<b>Angle int�rieur PK 210x70 D</b>				
	Mati�re synth�tique	blanc	K8495HB	46	2506
					
	<b>Angle ext�rieur PK 210x70 D</b>				
	Mati�re synth�tique	blanc	K8496HB	46	2506
					
	<b>Plaque de finition PK 210x70 D</b>				
	Mati�re synth�tique	blanc	K8497HB	46	2506
					

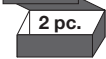
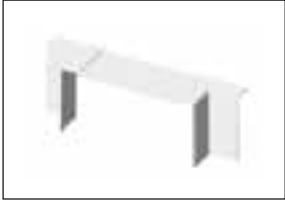
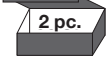

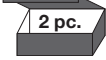

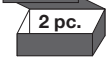

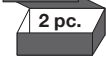

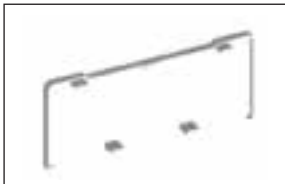
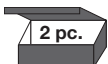
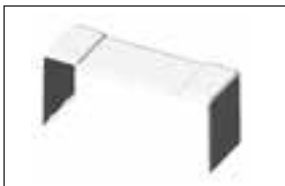

# Systemes de gaines murales PK

	type	référence	page catal.	groupe d'articles	prix en €	
	<b>Base + couvercle PK 110x70 D</b>					
	Matière synthétique	blanc	KPK110X70DHD	40	2501	22,54/m
	Matière synthétique exempte d'halogènes	blanc	KPK110X70DHFHD	54	2501	61,18/m
						
	<b>Embout PK 110x70 D</b>					
	Matière synthétique	blanc	K8451HB	40	2506	9,94/pc.
	Matière synthétique exempte d'halogènes	blanc	K8451HFHB	54	2506	11,81/pc.
						
	<b>Accouplement PK 110x70 D</b>					
	Matière synthétique	blanc	K8452HB	40	2506	9,27/pc.
	Matière synthétique exempte d'halogènes	blanc	K8452HFHB	54	2506	11,26/pc.
						
	<b>Angle plat PK 110x70 D</b>					
	Matière synthétique	blanc	K8453HB	40	2506	15,22/pc.
	Matière synthétique exempte d'halogènes	blanc	K8453HFHB	54	2506	17,18/pc.
						
	<b>Pièce en T PK 110x70 D</b>					
	Matière synthétique	blanc	K8454HB	40	2506	15,22/pc.
	Matière synthétique exempte d'halogènes	blanc	K8454HFHB	54	2506	17,18/pc.
						
	<b>Angle intérieur PK 110x70 D</b>					
	Matière synthétique	blanc	K8455HB	40	2506	16,11/pc.
	Matière synthétique exempte d'halogènes	blanc	K8455HFHB	54	2506	18,16/pc.
						
	<b>Angle extérieur PK 110x70 D</b>					
	Matière synthétique	blanc	K8456HB	40	2506	15,22/pc.
	Matière synthétique exempte d'halogènes	blanc	K8456HFHB	54	2506	17,18/pc.
						
	<b>Plaque de finition PK 110x70 D</b>					
	Matière synthétique	blanc	K8457HB	40	2506	5,52/pc.
	Matière synthétique exempte d'halogènes	blanc	K8457HFHB	54	2506	6,85/pc.
						

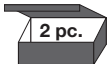
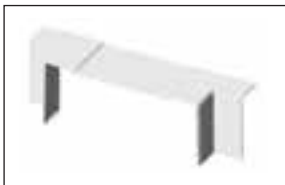
# Systemes de gaines murales PK

	type	référence	page catal.	groupe d'articles	prix en €
	<b>Base + couvercle PK 140x70 D</b>				
	Matière synthétique	blanc	KPK140X70DHD	41	2501
	 				
	<b>Embout PK 140x70 D</b>				
	Matière synthétique	blanc	K8461HB	41	2506
					
	<b>Accouplement PK 140x70 D</b>				
	Matière synthétique	blanc	K8462HB	41	2506
					
	<b>Angle plat PK 140x70 D</b>				
	Matière synthétique	blanc	K8463HB	41	2506
					
	<b>Pièce en T PK 140x70 D</b>				
	Matière synthétique	blanc	K8464HB	41	2506
					
	<b>Angle intérieur PK 140x70 D</b>				
	Matière synthétique	blanc	K8465HB	41	2506
					
	<b>Angle extérieur PK 140x70 D</b>				
	Matière synthétique	blanc	K8466HB	41	2506
					
	<b>Plaque de finition PK 140x70 D</b>				
	Matière synthétique	blanc	K8467HB	41	2506
					

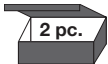
# Systemes de gaines murales PK











	type	référence	page catal.	groupe d'articles	prix en €
	<b>Base + couvercle PK 170x70 D</b>				
	Matière synthétique	blanc	KPK170X70DHD	42	2501
	 				
	<b>Embout PK 170x70 D</b>				
	Matière synthétique	blanc	K8441HB	42	2506
					
	<b>Accouplement PK 170x70 D</b>				
	Matière synthétique	blanc	K8442HB	42	2506
					
	<b>Angle plat PK 170x70 D</b>				
	Matière synthétique	blanc	K8443HB	42	2506
					
	<b>Pièce en T PK 170x70 D</b>				
	Matière synthétique	blanc	K8444HB	42	2506
					
	<b>Angle intérieur PK 170x70 D</b>				
	Matière synthétique	blanc	K8445HB	42	2506
					
	<b>Angle extérieur PK 170x70 D</b>				
	Matière synthétique	blanc	K8446HB	42	2506
					
	<b>Plaque de finition PK 170x70 D</b>				
	Matière synthétique	blanc	K8447HB	42	2506
					

# Systemes de gaines murales PK

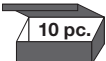

	type	référence	page catal.	groupe d'articles	prix en €	
	<b>Cloison de séparation H= 45 mm</b>					
	Matière synthétique	blanc	KPEKE60C	57	2501	5,96/m
	 					
	<b>Cloison de séparation H= 45 mm</b>					
	Matière synthétique avec feuillet métallique		KPKS70/60	57	2501	9,70/m
	 					
	<b>Cloison de séparation H= 29,5 mm</b>					
	Matière synthétique	blanc	KPEKD40C	57	2503	2,76/m
	Matière synthétique exempte d'halogènes	blanc	KPEKD40HFC	56	2503	7,07/m
	 					
	<b>Cloison de séparation H= 42,5 mm</b>					
	Matière synthétique	blanc	KPEP60HD	58	2501	11,77/m
	 					
	<b>Cloison de séparation H= 42,5 mm</b>					
	Acier		KPEP60/KS	58	2501	27,58/m
	 					
	<b>Canal de blindage pour gaines murales PK (110, 140, 170 et 210x70 et 120x55)</b>					
	Acier		KSK40X20S	59	2501	23,54/m
			KSK40X33S	59	2501	26,39/m
	 					
	<b>Etrier pour canaux de blindage SK (1 pc. = 12 étriers)</b>					
	Matière synthétique	blanc	KPSK1HB	59	2501	3,43/pc.
						
	<b>Câble de connexion pour canaux de blindage SK</b>					
	Cuivre		KPLSK	59	2501	4,69/pc.
	 					

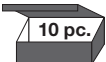















# Systemes de gaines murales PK

	type	référence	page catal.	groupe d'articles	prix en €	
	<b>Prise simple 45X45, 3P16A230V, 45°, avec sécurité-enfants, blanc</b>					
	Matière synthétique exempte d'halogènes	blanc	KQP45X45CHB	48	2501	11,75/pc.
						
	<b>Prise simple 45X45, 3P16A230V, 45°, avec sécurité-enfants, rouge</b>					
	Matière synthétique exempte d'halogènes	rouge	KQP45X45CBB	48	2501	12,65/pc.
						
	<b>Boîte d'appareillage pour gaines murales PK (110, 140, 170 et 210X70)</b>					
	Matière synthétique	blanc	KKPPKHB	61	2501	4,54/pc.
	Matière synthétique exempte d'halogènes	blanc	KKPPKHFHB	56	2501	6,69/pc.
						
	<b>Adaptateur pour gaines murales PK (140 et 170X70)</b>					
	Matière synthétique	blanc simple	K8440-11HB	64	2501	3,37/pc.
		blanc double	K8440-12HB	64	2501	4,41/pc.
		blanc triple	K8440-13HB	64	2501	7,19/pc.
						
	<b>Adaptateur pour gaines murales PK (110 et 210X70)</b>					
	Matière synthétique	blanc simple	K8450-11HB	64	2501	3,55/pc.
		blanc double	K8450-12HB	64	2501	4,41/pc.
		blanc triple	K8450-13HB	64	2501	7,19/pc.
						
	Matière synthétique exempte d'halogènes	blanc simple	K8450-11HFHB	56	2501	6,04/pc.
		blanc double	K8450-12HFHB	56	2501	7,36/pc.
	blanc triple	K8450-13HFHB	56	2501	11,77/pc.	
						
	<b>Support d'appareillage CEE pour gaines murales PK (140 et 170X70)</b>					
	Acier		KPNPKS	63	2501	45,46/pc.







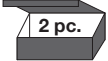



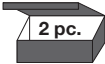

# Canal d'alimentation EKE

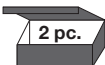
	type	référence	page catal.	groupe d'articles	prix en €
	<b>Base + couvercle EKE 60x60</b>				
	Matière synthétique	blanc	KEKE60X60HD	36	2503
	 				
	<b>Embout EKE 60x60</b>				
	Matière synthétique	blanc	K8541HB	36	2503
					
	<b>Accouplement EKE 60x60</b>				
	Matière synthétique	blanc	K8542HB	36	2503
					
	<b>Angle plat EKE 60x60</b>				
	Matière synthétique	blanc	K8543HB	36	2503
					
	<b>Pièce en T EKE 60x60</b>				
	Matière synthétique	blanc	K8544HB	36	2503
					
	<b>Angle intérieur EKE 60x60</b>				
	Matière synthétique	blanc	K8545HB	36	2503
					
	<b>Angle extérieur EKE 60x60</b>				
	Matière synthétique	blanc	K8546HB	36	2503
					

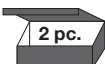

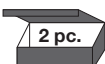

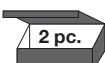

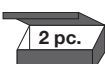



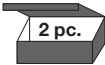

# Systemes de gaines murales EKE

	type	réf�rence	page catal.	groupe d'articles	prix en �
	<b>Base + couvercle EKE 100x60</b>				
	Mati�re synth�tique	blanc	KEKE100X60HD	37	2501
	 				
	<b>Embout EKE 100x60</b>				
	Mati�re synth�tique	blanc	K8551HB	37	2506
					
	<b>Accouplement EKE 100x60</b>				
	Mati�re synth�tique	blanc	K8552HB	37	2506
					
	<b>Angle plat EKE 100x60</b>				
	Mati�re synth�tique	blanc	K8553HB	37	2506
					
	<b>Pi�ce en T EKE 100x60</b>				
	Mati�re synth�tique	blanc	K8554HB	37	2506
					
	<b>Angle int�rieur EKE 100x60</b>				
	Mati�re synth�tique	blanc	K8555HB	37	2506
					
	<b>Angle ext�rieur EKE 100x60</b>				
	Mati�re synth�tique	blanc	K8556HB	37	2506
					

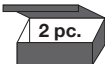

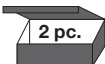

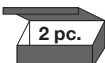

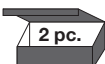













# Systemes de gaines murales EKE

	type	référence	page catal.	groupe d'articles	prix en €
	<b>Base + couvercle EKE 140x60</b>				
	Matière synthétique	blanc	KEKE140X60HD	38	2501
					
	<b>Embout EKE 140x60</b>				
	Matière synthétique	blanc	K8561HB	38	2506
					
	<b>Accouplement EKE 140x60</b>				
	Matière synthétique	blanc	K8562HB	38	2506
					
	<b>Angle plat EKE 140x60</b>				
	Matière synthétique	blanc	K8563HB	38	2506
					
	<b>Pièce en T EKE 140x60</b>				
	Matière synthétique	blanc	K8564HB	38	2506
					
	<b>Angle intérieur EKE 140x60</b>				
	Matière synthétique	blanc	K8565HB	38	2506
					
	<b>Angle extérieur EKE 140x60</b>				
	Matière synthétique	blanc	K8566HB	38	2506
					

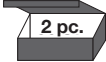
# Systemes de gaines murales EKE

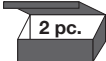
	type	réf�rence	page catal.	groupe d'articles	prix en �
	<b>Base + couvercle EKE 180x60</b>				
	Mati�re synth�tique	blanc	KEKE180X60HD	39	2501
					
	<b>Embout EKE 180x60</b>				
	Mati�re synth�tique	blanc	K8571HB	39	2506
					
	<b>Accouplement EKE 180x60</b>				
	Mati�re synth�tique	blanc	K8572HB	39	2506
					
	<b>Angle plat EKE 180x60</b>				
	Mati�re synth�tique	blanc	K8573HB	39	2506
					
	<b>Pi�ce en T EKE 180x60</b>				
	Mati�re synth�tique	blanc	K8574HB	39	2506
					
	<b>Angle int�rieur EKE 180x60</b>				
	Mati�re synth�tique	blanc	K8575HB	39	2506
					
	<b>Angle ext�rieur EKE 180x60</b>				
	Mati�re synth�tique	blanc	K8576HB	39	2506
					

# Systemes de gaines murales EKE











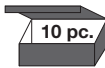

	type	référence	page catal.	groupe d'articles	prix en €	
	<b>Cloison de séparation H= 45 mm</b>					
	Matière synthétique	blanc	KPEKE60C	57	2501	5,96/m
						
	<b>Cloison de séparation H= 45 mm</b>					
	Matière synthétique avec feuillet métallique		KPKS70/60	57	2501	9,70/m
						
	<b>Cloison de séparation H= 42,5 mm</b>					
	Matière synthétique	blanc	KPEP60HD	58	2501	11,77/m
						
	<b>Cloison de séparation H= 42,5 mm</b>					
	Acier		KPEP60/KS	58	2501	27,58/m
						
	<b>Boîte d'appareillage pour gaines murales EKE (100, 140 et 180x60)</b>					
	Matière synthétique	blanc	KKPEKEHB	61	2501	4,87/pc.
						
	<b>Adaptateur pour gaines murales EKE (100x60)</b>					
	Matière synthétique	blanc simple	K8550-11HB	64	2501	3,54/pc.
		blanc double	K8550-12HB	64	2501	4,41/pc.
		blanc triple	K8550-13HB	64	2501	5,52/pc.
						
	<b>Adaptateur pour gaines murales EKE (140x60)</b>					
	Matière synthétique	blanc simple	K8560-11HB	64	2501	4,02/pc.
		blanc simple	K8560-12HB	64	2501	5,19/pc.
		blanc simple	K8560-13HB	64	2501	6,85/pc.
						
	<b>Support d'appareillage CEE pour gaines murales EKE (140 et 180x60)</b>					
	Acier		KPNEKES	63	2501	45,46/pc.
	<b>Canal de blindage pour gaines murales EKE (100, 140 et 180x60)</b>					
	Acier		KSK40X20S	59	2501	23,54/m
			KSK40X33S	59	2501	26,39/m
						

# Canaux de plinthe et de plafond LP35

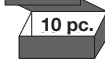
	type	référence	page catal.	groupe d'articles	prix en €	
	<b>Base + couvercle LP 35X25</b>					
	Matière synthétique					
		blanc	KLP35HD	32	2504	8,67/m
		bouleau rose	KLP35I1	32	2504	16,74/m
		chêne foncé	KLP35I2	32	2504	16,74/m
		brun clair	KLP35SD	32	2504	12,75/m
		brun foncé	KLP35TD	32	2504	12,75/m
	<b>Embout gauche LP 35X25</b>					
	Matière synthétique					
		blanc	K8861LHB	32	2504	3,58/pc.
		bouleau rose	K8861LI1	32	2504	7,73/pc.
		chêne foncé	K8861LI2	32	2504	7,73/pc.
		brun clair	K8861LSD	32	2504	7,73/pc.
	<b>Embout droit LP 35X25</b>					
Matière synthétique						
	blanc	K8861PHB	32	2504	3,58/pc.	
	bouleau rose	K8861PI1	32	2504	7,73/pc.	
	chêne foncé	K8861PI2	32	2504	7,73/pc.	
	brun clair	K8861PSD	32	2504	7,73/pc.	
	<b>Angle intérieur LP 35X25</b>					
	Matière synthétique					
		blanc	K8865HB	32	2504	3,58/pc.
		bouleau rose	K8865I1	32	2504	7,73/pc.
		chêne foncé	K8865I2	32	2504	7,73/pc.
		brun clair	K8865SD	32	2504	3,96/pc.
	<b>Angle extérieur LP 35X25</b>					
Matière synthétique						
	blanc	K8866HB	32	2504	3,58/pc.	
	bouleau rose	K8866I1	32	2504	7,73/pc.	
	chêne foncé	K8866I2	32	2504	7,73/pc.	
	brun clair	K8866SD	32	2504	3,96/pc.	
	<b>Boîte d'appareillage pour gaines LP 35X25</b>					
	Matière synthétique					
		blanc	KPNLP352ZHB	63	2504	6,16/pc.
		bouleau rose	KPNLP352ZI1	63	2504	11,92/pc.
		chêne foncé	KPNLP352ZI2	63	2504	11,92/pc.
		brun clair	KPNLP352ZSD	63	2504	9,78/pc.



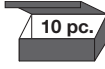

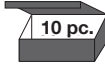





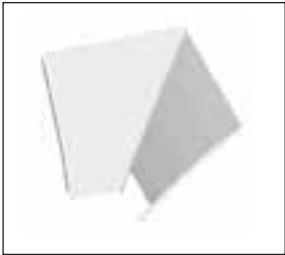

# Canaux de plinthe LP80

	type	référence	page catal.	groupe d'articles	prix en €
<b>Base + couvercle LP 80X25 et LPK 80X25</b>					
Matière synthétique					
 <p>LP</p>	 2 m	 16 m	blanc	KLP80X25HD	30 2504 9,47/m
			blanc	KLPK80X25HD	31 2504 9,72/m
 <p>LPK</p>					
<b>Embout gauche et droit pour LP 80X25 et LPK 80X25</b>					
Matière synthétique					
	 10 pc.		blanc gauche	K8821LHB	30-31 2504 2,70/pc.
			blanc droit	K8821PHB	30-31 2504 2,70/pc.
<b>Accouplement LP 80X25</b>					
Matière synthétique					
	 10 pc.		blanc	K8822HB	30-31 2504 2,70/pc.
<b>Angle intérieur LP 80X25</b>					
Matière synthétique					
	 10 pc.		blanc	K8825HB	30-31 2504 3,67/pc.
<b>Angle extérieur LP 80X25</b>					
Matière synthétique					
	 10 pc.		blanc	K8826HB	30-31 2504 3,67/pc.
<b>Boîte d'appareillage pour gaines LP 80X25 et LPK 80X25</b>					
Matière synthétique					
	 10 pc.		blanc simple	KPN80X25HB	62 2504 7,06/pc.
			blanc double	KPN80X25ZHB	62 2504 7,29/pc.



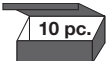

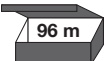

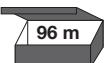



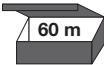
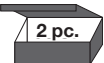

# Canaux de plinthe LP80

	type	référence	page catal.	groupe d'articles	prix en €
	<b>Transition de LP(K) 80X25 vers LHD 20X20</b>				
	Matière synthétique				
	blanc	K8824/12HB	30-31	2504	3,67/pc.
	<b>Transition de LP(K) 80X25 vers LZK 15X12</b>				
	Matière synthétique				
	blanc	K8824/40HB	30-31	2504	3,67/pc.
	<b>Transition de LP(K) 80X25 vers LZ 15X12</b>				
	Matière synthétique				
	blanc	K8824/41HB	30-31	2504	3,67/pc.
	<b>Transition de LP(K) 80X25 vers LO 35</b>				
	Matière synthétique				
	blanc	K8824/43HB	30-31	2504	3,67/pc.
	<b>Transition de LP(K) 80X25 vers LO 50</b>				
	Matière synthétique				
	blanc	K8824/44HB	30-31	2504	3,67/pc.
	<b>Transition de LP(K) 80X25 vers LHD 40X20</b>				
	Matière synthétique				
		blanc gauche	K8823/13LHB	30-31	2504
	blanc droit	K8823/13PHB	30-31	2504	3,67/pc.

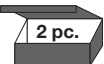
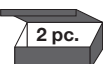



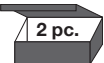







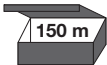

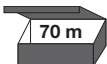

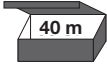

# Canal LR30 et canaux avec couvercle à charnière LZ

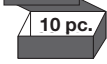
	type	référence	page catal.	groupe d'articles	prix en €
	<b>Base + couvercle LR30</b>				
	Matière synthétique				
 		KLR30HB	29	2504	9,82/m
	<b>Angle intérieur LR30</b>				
	Matière synthétique				
		K8855HB	29	2504	1,99/pc.
	<b>Angle intérieur 3 entrées LR30</b>				
	Matière synthétique				
		K8855/3HB	29	2504	1,99/pc.
	<b>Angle extérieur LR30</b>				
	Matière synthétique				
		K8856HB	29	2504	1,99/pc.
	<b>Base + couvercle à charnière LZ 15X12</b>				
	Matière synthétique				
 	blanc	KLZ15X12HD	8	2503	1,24/m
	gris clair	KLZ15X12KD	8	2503	1,29/m
	<b>Base + couvercle à charnière rond LZK 15X12</b>				
	Matière synthétique				
 	blanc	KLZK15X12HD	9	2503	1,24/m



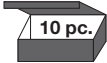



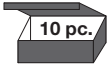

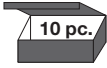

# Canaux de sol LO

	type	référence	page catal.	groupe d'articles	prix en €		
	<b>Base + couvercle LO 35</b>						
	Matière synthétique						
			blanc	KLO35HD	26	2504	5,08/m
			blanc + autoc.	KLO35P2	26	2504	5,35/m
			gris clair	KLO35KD	26	2504	5,08/m
			gris foncé	KLO35LD	26	2504	5,08/m
	<b>Angle plat</b>		blanc	K8833HB	26	2504	2,80/pc.
			gris clair	K8833KB	26	2504	2,80/pc.
			gris foncé	K8833LB	26	2504	2,80/pc.
	<b>Pièce en T</b>		blanc	K8834HB	26	2504	2,55/pc.
			gris clair	K8834KB	26	2504	2,55/pc.
			gris foncé	K8834LB	26	2504	2,55/pc.
	<b>Base + couvercle LO 50</b>						
	Matière synthétique						
			blanc	KLO50HD	27	2504	7,23/m
			blanc + autoc.	KLO50P2	27	2504	8,12/m
			gris clair	KLO50KD	27	2504	7,23/m
			gris foncé	KLO50LD	27	2504	7,23/m
	<b>Angle plat</b>		blanc	K8843HB	27	2504	3,11/pc.
			gris clair	K8843KB	27	2504	3,11/pc.
			gris foncé	K8843LB	27	2504	3,11/pc.
	<b>Pièce en T</b>		blanc	K8844HB	27	2504	2,94/pc.
			gris clair	K8844KB	27	2504	2,94/pc.
			gris foncé	K8844LB	27	2504	2,94/pc.
	<b>Base + couvercle LO 75</b>						
	Matière synthétique						
			blanc	KLO75HD	28	2504	8,89/m
			blanc + autoc.	KLO75P2	28	2504	11,08/m
			gris clair	KLO75KD	28	2504	8,89/m
			gris foncé	KLO75LD	28	2504	8,89/m
	<b>Angle plat</b>		blanc	K8873HB	28	2504	3,65/pc.
			gris clair	K8873KB	28	2504	3,65/pc.
			gris foncé	K8873LB	28	2504	3,65/pc.
	<b>Pièce en T</b>		blanc	K8874HB	28	2504	3,25/pc.
			gris clair	K8874KB	28	2504	3,25/pc.
			gris foncé	K8874LB	28	2504	3,25/pc.
	<b>Pince pour réaliser des ouvertures</b>						
	Matière synthétique / acier						
		KVK20	65	2503	257,00/pc.		
	<b>Pince pour canaux jusqu'à 40X20 mm ou 40 mm</b>						
	Matière synthétique / acier						
		KL-42W	65	2503	176,86/pc.		

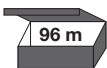
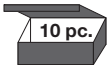

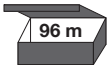
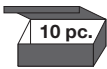

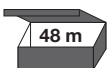

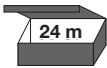
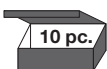

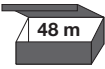
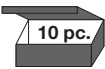

# Canaux d'alimentation LV, LH, LHD et EKD

	type	référence	page catal.	groupe d'articles	prix en €	
	<b>Base + couvercle LV 11X10</b>					
	Matière synthétique					
			blanc KLV11X10HD blanc + autoc. KLV11X10P2	4 4	2503 2503	0,91/m 1,72/m
	<b>Base + couvercle LV 18X13</b>					
	Matière synthétique					
			blanc KLV18X13HD blanc + autoc. KLV18X13P2 brun clair KLV18X13SD brun foncé KLV18X13TD	5 5 5 5	2503 2503 2503 2503	1,25/m 2,23/m 1,69/m 1,69/m
	<b>Embout</b>		blanc K8731HB	5	2503	0,93/pc.
	<b>Accouplement</b>		blanc K8732HB	5	2503	0,93/pc.
	<b>Angle plat</b>		blanc K8733HB	5	2503	1,41/pc.
	<b>Pièce en T</b>		blanc K8734HB	5	2503	1,41/pc.
	<b>Angle intérieur</b>		blanc K8735HB	5	2503	1,41/pc.
	<b>Angle extérieur</b>		blanc K8736HB	5	2503	1,41/pc.
		<b>Base + couvercle LV 24X22</b>				
Matière synthétique						
			blanc KLV24X22HD	6	2503	1,98/m
			blanc + autoc. KLV24X22P2	6	2503	3,15/m
<b>Embout</b>			blanc K8791HB	6	2503	1,06/pc.
<b>Accouplement</b>			blanc K8792HB	6	2503	1,06/pc.
<b>Angle plat</b>			blanc K8793HB	6	2503	1,52/pc.
<b>Pièce en T</b>			blanc K8794HB	6	2503	1,52/pc.
<b>Angle intérieur</b>			blanc K8795HB	6	2503	1,52/pc.
<b>Angle extérieur</b>			blanc K8796HB	6	2503	1,52/pc.
	<b>Base + couvercle LV 40X15</b>					
	Matière synthétique					
			blanc KLV40X15HD blanc + autoc. KLV40X15P2	7 7	2503 2503	2,50/m 3,90/m
	<b>Embout</b>		blanc K8711HB	7	2503	1,61/pc.
	<b>Accouplement</b>		blanc K8714HB	7	2503	1,61/pc.
	<b>Angle plat</b>		blanc K8716HB	7	2503	1,88/pc.
	<b>Pièce en T</b>		blanc K8715HB	7	2503	1,88/pc.
	<b>Angle intérieur</b>		blanc K8713/2HB	7	2503	1,88/pc.
	<b>Angle extérieur</b>		blanc K8712/2HB	7	2503	1,88/pc.
		<b>Base + couvercle LH 15X10</b>				
Matière synthétique						
			blanc KLH15X10HD blanc + autoc. KLH15X10P2	10 10	2503 2503	0,94/m 1,75/m
<b>Embout</b>			blanc K8681HB	10	2503	0,75/pc.
<b>Accouplement</b>			blanc K8682HB	10	2503	0,75/pc.
<b>Angle plat</b>			blanc K8683HB	10	2503	1,12/pc.
<b>Pièce en T</b>			blanc K8684HB	10	2503	1,12/pc.
<b>Angle intérieur</b>			blanc K8685HB	10	2503	1,12/pc.
<b>Angle extérieur</b>			blanc K8686HB	10	2503	1,12/pc.

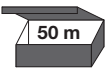
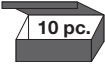
# Canaux d'alimentation LV, LH, LHD et EKD



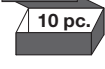

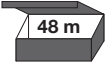
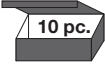



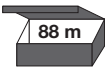
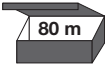
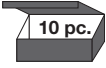

	type	référence	page catal.	groupe d'articles	prix en €		
	<b>Base + couvercle LHD 17X17</b>						
	Matière synthétique						
			blanc	KLHD17X17HD	11	2503	1,30/m
			blanc + autoc.	KLHD17X17P2	11	2503	1,98/m
	<b>Embout</b>		blanc	K8671HB	11	2503	0,95/pc.
	<b>Accouplement</b>		blanc	K8672HB	11	2503	0,95/pc.
	<b>Angle plat</b>		blanc	K8673HB	11	2503	1,41/pc.
	<b>Pièce en T</b>		blanc	K8674HB	11	2503	1,41/pc.
	<b>Angle intérieur</b>		blanc	K8675HB	11	2503	1,41/pc.
	<b>Angle extérieur</b>		blanc	K8676HB	11	2503	1,41/pc.
	<b>Base + couvercle LHD 20X10</b>						
	Matière synthétique						
			blanc	KLHD20X10HD	12	2503	1,19/m
			blanc + autoc.	KLHD20X10P2	12	2503	2,08/m
	<b>Embout</b>		blanc	K8921HB	12	2503	0,95/pc.
	<b>Accouplement</b>		blanc	K8922HB	12	2503	0,95/pc.
	<b>Angle plat</b>		blanc	K8923HB	12	2503	1,41/pc.
	<b>Pièce en T</b>		blanc	K8924HB	12	2503	1,41/pc.
	<b>Angle intérieur</b>		blanc	K8925HB	12	2503	1,41/pc.
	<b>Angle extérieur</b>		blanc	K8926HB	12	2503	1,41/pc.
	<b>Base + couvercle LHD 20X10 HF</b>						
	Matière synthétique exempte d'halogènes						
			blanc	KLHD20X10HFHD	49	2503	4,21/m
	<b>Embout</b>		blanc	K8921HFHB	49	2503	3,05/pc.
	<b>Accouplement</b>		blanc	K8922HFHB	49	2503	3,05/pc.
	<b>Angle plat</b>		blanc	K8923HFHB	49	2503	4,50/pc.
	<b>Pièce en T</b>		blanc	K8924HFHB	49	2503	4,50/pc.
	<b>Angle intérieur</b>		blanc	K8925HFHB	49	2503	4,50/pc.
	<b>Angle extérieur</b>		blanc	K8926HFHB	49	2503	4,50/pc.
		<b>Base + couvercle LHD 20X20</b>					
Matière synthétique							
			blanc	KLHD20X20HD	13	2503	1,61/m
			blanc + autoc.	KLHD20X20P2	13	2503	2,76/m
			brun clair	KLHD20X20SD	13	2503	2,01/m
			brun foncé	KLHD20X20TD	13	2503	2,01/m
			bouleau rose	KLHD20X20I1	13	2503	15,01/m
			chêne foncé	KLHD20X20I2	13	2503	15,01/m
<b>Embout</b>			blanc	K8621HB	13	2503	1,00/pc.
<b>Accouplement</b>			blanc	K8622HB	13	2503	1,00/pc.
<b>Angle plat</b>		blanc	K8623HB	13	2503	1,58/pc.	
<b>Pièce en T</b>		blanc	K8624HB	13	2503	1,58/pc.	
<b>Angle intérieur</b>		blanc	K8625HB	13	2503	1,58/pc.	
<b>Angle extérieur</b>		blanc	K8626HB	13	2503	1,58/pc.	

# Canaux d'alimentation LV, LH, LHD et EKD



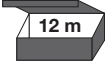
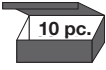

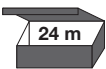
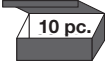

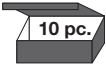



	type	référence	page catal.	groupe d'articles	prix en €		
	<b>Base + couvercle LHD 20X20 HF</b>						
	Matière synthétique exempte d'halogènes						
			blanc	KLHD20X20HFHD	50	2503	6,49/m
	<b>Embout</b>		blanc	K8621HFHB	50	2503	3,31/pc.
	<b>Accouplement</b>		blanc	K8622HFHB	50	2503	3,31/pc.
	<b>Angle plat</b>		blanc	K8623HFHB	50	2503	4,83/pc.
	<b>Pièce en T</b>		blanc	K8624HFHB	50	2503	4,83/pc.
<b>Angle intérieur</b>		blanc	K8625HFHB	50	2503	4,83/pc.	
<b>Angle extérieur</b>		blanc	K8626HFHB	50	2503	4,83/pc.	
	<b>Base + couvercle LHD 25X15</b>						
	Matière synthétique						
			blanc	KLHD25X15HD	14	2503	1,59/m
			blanc + autoc.	KLHD25X15P2	14	2503	2,76/m
	<b>Embout</b>		blanc	K8691HB	14	2503	1,04/pc.
	<b>Accouplement</b>		blanc	K8692HB	14	2503	1,04/pc.
	<b>Angle plat</b>		blanc	K8693HB	14	2503	1,60/pc.
<b>Pièce en T</b>		blanc	K8694HB	14	2503	1,60/pc.	
<b>Angle intérieur</b>		blanc	K8695HB	14	2503	1,60/pc.	
<b>Angle extérieur</b>		blanc	K8696HB	14	2503	1,60/pc.	
	<b>Base + couvercle LHD 25X20</b>						
	Matière synthétique						
			blanc	KLHD25X20HD	15	2503	1,95/m
			blanc + autoc.	KLHD25X20P2	15	2503	3,12/m
	<b>Embout</b>		blanc	K8911HB	15	2503	1,06/pc.
	<b>Accouplement</b>		blanc	K8912HB	15	2503	1,06/pc.
	<b>Angle plat</b>		blanc	K8913HB	15	2503	1,52/pc.
<b>Pièce en T</b>		blanc	K8914HB	15	2503	1,52/pc.	
<b>Angle intérieur</b>		blanc	K8915HB	15	2503	1,52/pc.	
<b>Angle extérieur</b>		blanc	K8916HB	15	2503	1,52/pc.	
	<b>Base + couvercle LHD 30X25</b>						
	Matière synthétique						
			blanc	KLHD30X25HD	16	2503	2,19/m
			blanc + autoc.	KLHD30X25P2	16	2503	3,25/m
	<b>Embout</b>		blanc	K8931HB	16	2503	1,54/pc.
	<b>Accouplement</b>		blanc	K8932HB	16	2503	1,54/pc.
	<b>Angle plat</b>		blanc	K8933HB	16	2503	2,18/pc.
<b>Pièce en T</b>		blanc	K8934HB	16	2503	2,18/pc.	
<b>Angle intérieur</b>		blanc	K8935HB	16	2503	2,18/pc.	
<b>Angle extérieur</b>		blanc	K8936HB	16	2503	2,18/pc.	

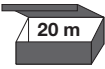
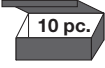

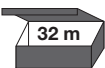
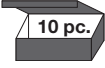



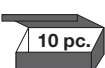
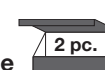

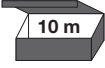
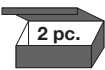
# Canaux d'alimentation LV, LH, LHD et EKD

	type	référence	page catal.	groupe d'articles	prix en €		
	<b>Base + couvercle LHD 32X15</b>						
	Matière synthétique						
			blanc	KLHD32X15HD	17	2503	1,85/m
			blanc + autoc.	KLHD32X15P2	17	2503	3,09/m
	<b>Embout</b>		blanc	K8601HB	17	2503	1,04/pc.
	<b>Accouplement</b>		blanc	K8602HB	17	2503	1,04/pc.
	<b>Angle plat</b>		blanc	K8603HB	17	2503	1,58/pc.
	<b>Pièce en T</b>		blanc	K8604HB	17	2503	1,58/pc.
	<b>Angle intérieur</b>		blanc	K8605HB	17	2503	1,58/pc.
	<b>Angle extérieur</b>		blanc	K8606HB	17	2503	1,58/pc.
	<b>Base + couvercle LHD 40X20</b>						
	Matière synthétique						
			blanc	KLHD40X20HD	18	2503	2,53/m
			blanc + autoc.	KLHD40X20P2	18	2503	3,96/m
			brun clair	KLHD40X20SD	18	2503	3,09/m
			brun foncé	KLHD40X20TD	18	2503	3,09/m
			bouleau rose	KLHD40X20I1	18	2503	17,45/m
			chêne foncé	KLHD40X20I2	18	2503	17,45/m
	<b>Embout</b>		blanc	K8631HB	18	2503	1,91/pc.
	<b>Accouplement</b>		blanc	K8632HB	18	2503	1,91/pc.
<b>Angle plat</b>		blanc	K8633HB	18	2503	2,59/pc.	
<b>Pièce en T</b>		blanc	K8634HB	18	2503	2,59/pc.	
<b>Angle intérieur</b>		blanc	K8635HB	18	2503	2,59/pc.	
<b>Angle extérieur</b>		blanc	K8636HB	18	2503	2,59/pc.	
	<b>Base + couvercle LHD 40X20 HF</b>						
	Matière synthétique exempte d'halogènes						
			blanc	KLHD40X20HFHD	51	2503	10,70/m
	<b>Embout</b>		blanc	K8631HFHB	51	2503	5,78/pc.
	<b>Accouplement</b>		blanc	K8632HFHB	51	2503	5,78/pc.
	<b>Angle plat</b>		blanc	K8633HFHB	51	2503	8,13/pc.
	<b>Pièce en T</b>		blanc	K8634HFHB	51	2503	8,13/pc.
	<b>Angle intérieur</b>		blanc	K8635HFHB	51	2503	8,13/pc.
	<b>Angle extérieur</b>		blanc	K8636HFHB	51	2503	8,13/pc.
		<b>Base + couvercle LHD 40X40</b>					
Matière synthétique							
			blanc	KLHD40X40HD	19	2503	4,06/m
			brun clair	KLHD40X40SD	19	2503	7,35/m
			brun foncé	KLHD40X40TD	19	2503	7,35/m
<b>Embout</b>			blanc	K8641HB	19	2503	2,37/pc.
<b>Accouplement</b>			blanc	K8642HB	19	2503	2,37/pc.
<b>Angle plat</b>			blanc	K8643HB	19	2503	3,12/pc.
<b>Pièce en T</b>			blanc	K8644HB	19	2503	3,12/pc.
<b>Angle intérieur</b>			blanc	K8645HB	19	2503	3,12/pc.
<b>Angle extérieur</b>		blanc	K8646HB	19	2503	3,12/pc.	



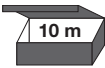

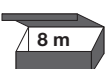
# Canaux d'alimentation LV, LH, LHD et EKD

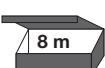
	type	référence	page catal.	groupe d'articles	prix en €		
	<b>Base + couvercle LHD 40X40 HF</b>						
	Matière synthétique exempte d'halogènes						
			blanc	KLHD40X40HFHD	52	2503	15,90/m
	<b>Embout</b>	blanc	K8641HFHB	52	2503	7,36/pc.	
	<b>Accouplement</b>	blanc	K8642HFHB	52	2503	7,36/pc.	
	<b>Angle plat</b>	blanc	K8643HFHB	52	2503	8,26/pc.	
	<b>Pièce en T</b>		blanc	K8644HFHB	52	2503	8,26/pc.
	<b>Angle intérieur</b>	blanc	K8645HFHB	52	2503	8,26/pc.	
	<b>Angle extérieur</b>	blanc	K8646HFHB	52	2503	8,26/pc.	
		<b>Base + couvercle LHD 50x20, LHD 50x20/1 et LHD 50x20/2</b>					
Matière synthétique							
			blanc	KLHD50X20HD	20	2503	3,30/m
			blanc	KLHD50X20/1HD	20	2503	3,50/m
			blanc	KLHD50X20/2HD	20	2503	3,77/m
<b>Embout</b>		blanc	K8991HB	20	2503	1,99/pc.	
<b>Accouplement</b>		blanc	K8992HB	20	2503	1,99/pc.	
<b>Angle plat</b>		blanc	K8993HB	20	2503	2,83/pc.	
<b>Pièce en T</b>			blanc	K8994HB	20	2503	2,83/pc.
<b>Angle intérieur</b>		blanc	K8995HB	20	2503	2,83/pc.	
<b>Angle extérieur</b>	blanc	K8996HB	20	2503	2,83/pc.		
	<b>Base + couvercle LH 60x40</b>						
	Matière synthétique						
			blanc	KLH60X40HD	21	2503	7,46/m
	<b>Embout</b>	blanc	K8651HB	21	2503	2,78/pc.	
	<b>Accouplement</b>	blanc	K8652HB	21	2503	2,78/pc.	
	<b>Angle plat</b>	blanc	K8653HB	21	2503	3,77/pc.	
	<b>Pièce en T</b>		blanc	K8654HB	21	2503	3,77/pc.
	<b>Angle intérieur</b>	blanc	K8655HB	21	2503	3,77/pc.	
	<b>Angle extérieur</b>	blanc	K8656HB	21	2503	3,77/pc.	
	<b>Angle plat rond</b>		blanc	K8653RHB	21	2503	3,77/pc.
<b>Pièce en T ronde</b>	blanc	K8654RHB	21	2503	3,77/pc.		
	<b>Base + couvercle EKD 80X40</b>						
	Matière synthétique						
			blanc	KEKD80X40HD	33	2503	9,08/m
	<b>Embout</b>	blanc	K8501HB	33	2503	4,19/pc.	
	<b>Accouplement</b>	blanc	K8502HB	33	2503	4,19/pc.	
	<b>Angle plat</b>	blanc	K8503HB	33	2503	5,96/pc.	
	<b>Pièce en T</b>		blanc	K8504HB	33	2503	5,73/pc.
	<b>Dérivation</b>	blanc	K8504/EKDHB	33	2503	5,41/pc.	
	<b>Angle intérieur</b>	blanc	K8505HB	33	2503	5,96/pc.	
	<b>Angle extérieur</b>	blanc	K8506HB	33	2503	5,96/pc.	

# Canaux d'alimentation LV, LH, LHD et EKD

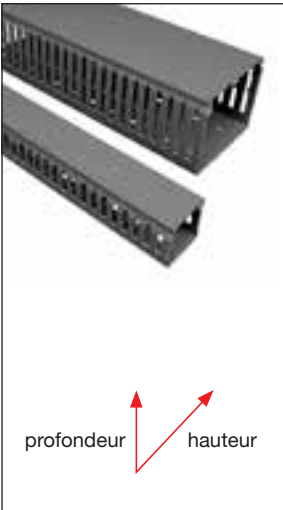
	type	référence	page catal.	groupe d'articles	prix en €	
	<b>Base + couvercle EKD 80X40 HF</b>					
	Matière synthétique exempte d'halogènes					
	 	blanc	KEKD80X40HFHD	53	2503	27,90/m
	<b>Embout</b>	blanc	K8501HFHB	53	2503	11,71/pc.
	<b>Accouplement</b>	blanc	K8502HFHB	53	2503	11,71/pc.
	<b>Angle plat</b>	blanc	K8503HFHB	53	2503	15,46/pc.
	<b>Pièce en T</b>	blanc	K8504HFHB	53	2503	15,46/pc.
	<b>Base + couvercle EKD 100X40</b>					
	Matière synthétique					
	 	blanc	KEKD100X40HD	34	2503	10,70/m
	<b>Embout</b>	blanc	K8511HB	34	2503	5,52/pc.
	<b>Accouplement</b>	blanc	K8512HB	34	2503	5,52/pc.
	<b>Angle plat</b>	blanc	K8513HB	34	2503	7,29/pc.
	<b>Pièce en T</b>	blanc	K8514HB	34	2503	7,29/pc.
	<b>Base + couvercle EKD 120x40</b>					
	Matière synthétique					
	 	blanc	KEKD120X40HD	35	2503	12,65/m
	<b>Embout</b>	blanc	K8581HB	35	2503	5,89/pc.
	<b>Accouplement</b>	blanc	K8582HB	35	2503	5,89/pc.
	<b>Angle plat</b>	blanc	K8583HB	35	2503	8,83/pc.
	<b>Pièce en T</b>	blanc	K8584HB	35	2503	8,83/pc.
<b>Dérivation</b>	blanc	K8584/EKDHB	35	2503	8,83/pc.	
<b>Angle intérieur</b>	blanc	K8585HB	35	2503	8,83/pc.	
<b>Angle extérieur</b>	blanc	K8586HB	35	2503	8,83/pc.	

# Canaux de câblage RK

	type	référence	page catal.	groupe d'articles	prix en €		
<b>Base + couvercle RK...X...</b>							
Matière synthétique gris pierre RAL 7030							
 <p>profondeur ↗ hauteur ↗</p>	2 m	hauteur x profondeur					
		64 m	30x30	KRK30X30LD	68	2505	5,85/m
		60 m	30x40	KRK30X40LD	68	2505	6,90/m
		48 m	40x60	KRK40X60LD	68	2505	8,52/m
		36 m	60x60	KRK60X60LD	68	2505	8,45/m
		32 m	80x60	KRK80X60LD	68	2505	13,11/m
		22 m	100x60	KRK100X60LD	68	2505	12,63/m
		40 m	40x80	KRK40X80LD	68	2505	8,82/m
		36 m	60x80	KRK60X80LD	68	2505	9,43/m
		24 m	40x100	KRK40X100LD	68	2505	16,69/m
		20 m	80x100	KRK80X100LD	68	2505	20,13/m
<b>Base + couvercle RK...X...HF</b>							
Matière synthétique exempte d'halogènes gris clair RAL7035							
 <p>profondeur ↗ hauteur ↗</p>	2 m	hauteur x profondeur					
		40 m	37,5x37,5	KRK37.5X37.5HFLD	69	2505	15,38/m
		32 m	37,5x50	KRK37.5X50HFLD	69	2505	18,41/m
		42 m	50x50	KRK50X50HFLD	69	2505	19,27/m
		28 m	75x50	KRK75X50HFLD	69	2505	29,60/m
		28 m	50x75	KRK50X75HFLD	69	2505	27,10/m
		24 m	75x75	KRK75X75HFLD	69	2505	34,52/m
		16 m	125x75	KRK125X75HFLD	69	2505	46,99/m
	<b>Canal de câblage flexible RK-OVK</b>						
Matière synthétique gris pierre RAL7030							
	0,5 m						
		60 pc.	Ø20	KRK-OVK20LA	69	2505	9,72/pc.
		36 pc.	Ø30	KRK-OVK30LB	69	2505	10,21/pc.
		24 pc.	Ø40	KRK-OVK40LB	69	2505	11,81/pc.
<b>Canal de câblage en spirale RK-ST</b>							
Matière synthétique							
		25 m	Ø6	KRK-ST6H25	69	2505	1,48/m
		25 m	Ø12	KRK-ST12H25	69	2505	2,38/m
		25 m	Ø22	KRK-ST22H25	69	2505	5,99/m

# Colonnes de distribution et de bureau





## Fonctionnalité supérieure design élané

- ✓ disponible en version simple et double
- ✓ en aluminium anodisé ou blanc laqué RAL 9010
- ✓ les mécanismes 45x45 mm s'encliquettent directement dans l'ouverture du couvercle, sans faire usage de boîtes d'appareillage
- ✓ montage simple et rapide
- ✓ 3 types : installés comme colonne de bureau fixe, comme colonne tendue entre le plafond et le sol ou comme colonne mobile
- ✓ plusieurs accessoires et finitions possibles.

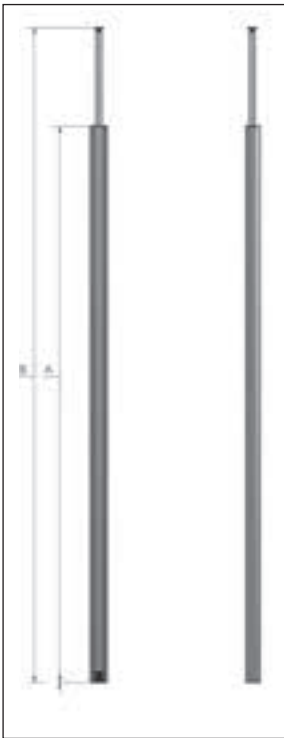

Caractéristiques	Tendue entre le sol et le plafond	Libre et mobile	Colonne de bureau
Aluminium, anodisé	✓	✓	✓
Aluminium, blanc laqué RAL 9010	✓	✓	✓
Dimensions (mm)	<b>Profilé (plage de réglage)</b> 2550 (2670-3070) 2750 (2870-3270) 3050 (3170-3570) 4000 (4120-4520)	<b>Profilé (flexible)</b> 2150 (2000) <b>Diamètre socle</b> 350	<b>Profilé</b> 683 <b>Diamètre socle</b> 170
Version simple	✓	✓	✓
Version double	✓	✓	✓
Mécanismes 45x45mm	✓	✓	✓
	page 206-207	page 208-209	page 210

# Colonnes de distribution IDT

	type	référence	page catal.	groupe d'articles	prix en €	
<b>Colonne de distribution tendue entre le sol et le plafond, simple</b>						
	Aluminium					
		<b>A</b>	<b>B</b>			
	2550	2670-3070 anodisé blanc laqué	IDT6305 IDT6302	5 5	2701 2701	290,91/pc. 290,91/pc.
	2750	2870-3270 anodisé blanc laqué	IDT6306 IDT6303	5 5	2701 2701	303,71/pc. 303,71/pc.
	3050	3170-3570 anodisé blanc laqué	IDT6307 IDT6304	5 5	2701 2701	322,33/pc. 322,33/pc.
	4000	4120-4520 anodisé blanc laqué	IDT7218 IDT7239	5 5	2701 2701	444,48/pc. 444,48/pc.
	<b>Plaque de plafond, simple</b>					
		Matière synthétique				
		blanc	IDT2917	5	2701	9,65/pc.
	<b>Set avec conducteur de terre et serre-câbles</b>					
			IDT6894	5	2701	11,76/pc.

# Colonnes de distribution IDT

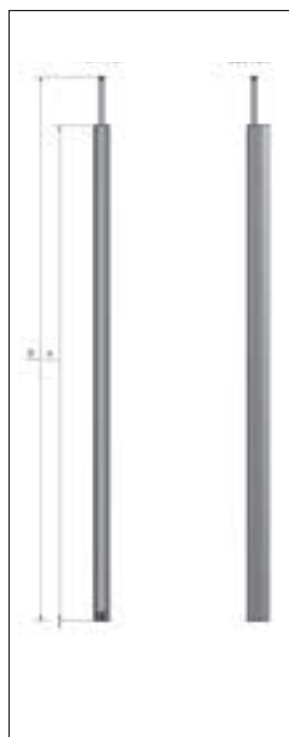

## Colonne de distribution tendue entre le sol et le plafond, double

Aluminium	type	référence	page catal.	groupe d'articles	prix en €
	A	B			
2550	2670-3070 anodisé blanc laqué	IDT0022	5	2701	407,40/pc.
		IDT0019	5	2701	407,40/pc.
2750	2870-3270 anodisé blanc laqué	IDT0023	5	2701	429,32/pc.
		IDT0020	5	2701	429,32/pc.
3050	3170-3570 anodisé blanc laqué	IDT0024	5	2701	461,40/pc.
		IDT0021	5	2701	461,40/pc.
4000	4120-4520 anodisé blanc laqué	IDT7219	5	2701	702,71/pc.
		IDT7240	5	2701	702,71/pc.



## Plaque de plafond, double

Matière synthétique	type	référence	page catal.	groupe d'articles	prix en €
	blanc	IDT6893	5	2701	12,82/pc.





## Set avec conducteur de terre et serre-câbles



		IDT6894	5	2701	11,76/pc.
--	--	---------	---	------	-----------

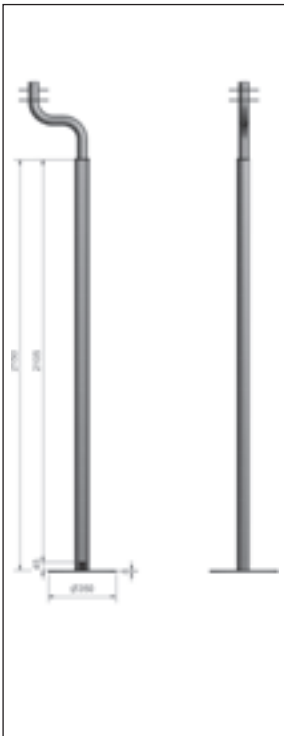

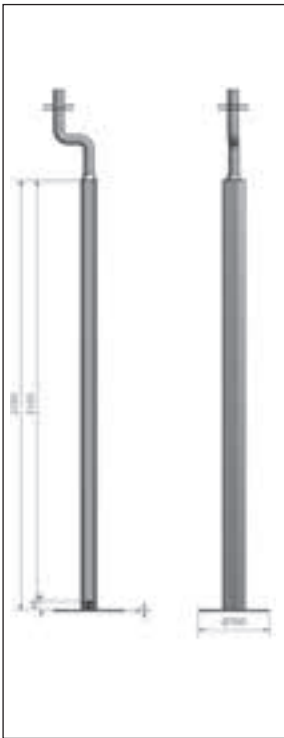

# Colonnes de distribution IDT

	type	référence	page catal.	groupe d'articles	prix en €
	<b>Colonne de distribution mobile, simple la plaque de plafond en acier laqué blanc et le flexible gris ou blanc L=2000 mm sont inclus</b>				
	Aluminium	A			
	2150	anodisé blanc laqué	IDT6301 IDT6300	7 7	2701 2701
<p>Le socle est à commander séparément.</p>					
	<b>Socle pour colonne de distribution mobile, simple</b>				
	Acier				
		gris laqué blanc laqué	IDT2941 IDT2942	7 7	2701 2701
	<b>Set avec conducteur de terre et serre-câbles</b>				
			IDT6894	7	2701

# Colonnes de distribution IDT

	type	référence	page catal.	groupe d'articles	prix en €
	<b>Colonne de distribution mobile, double la plaque de plafond en acier laqué blanc et le flexible gris ou blanc L=2000 mm sont inclus</b>				
	Aluminium	A			
	2150	anodisé blanc laqué	IDT0010 IDT0009	7 7	2701 2701
	Le socle est à commander séparément.				
	<b>Socle pour colonne de distribution mobile, double</b>				
	Acier				
		gris laqué blanc laqué	IDT0011 IDT0012	7 7	2701 2701
	<b>Set avec conducteur de terre et serre-câbles</b>				
			IDT6894	7	2701

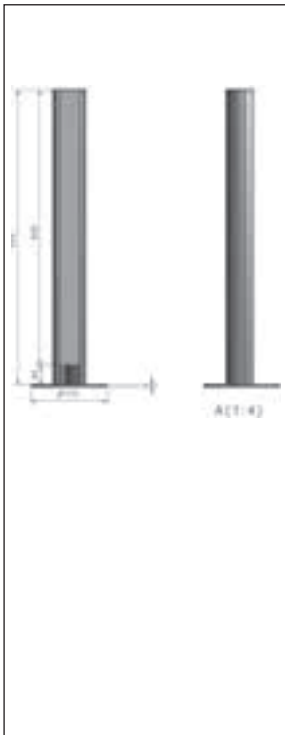
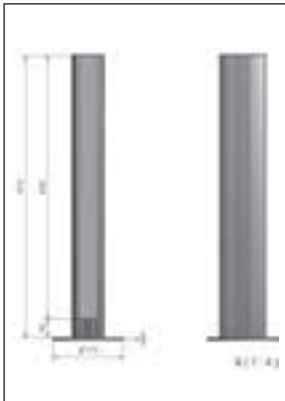
# Colonnes de distribution IDT

	type	référence	page catal.	groupe d'articles	prix en €	
<b>Colonne de bureau, simple</b>						
	Aluminium	anodisé	IDT6299	9	2701	166,81/pc.
		blanc	IDT6298	9	2701	166,81/pc.
<p>Le socle rond est déjà fixé au profilé de la colonne de bureau.</p>						
<b>Colonne de bureau, double</b>						
	Aluminium	anodisé	IDT0004	9	2701	222,41/pc.
		blanc	IDT0003	9	2701	222,41/pc.
<p>Le socle rond est déjà fixé au profilé de la colonne de bureau.</p>						
<b>Set avec conducteur de terre et serre-câbles</b>						
			IDT6894	9	2701	11,76/pc.



# Connexions bureautiques

Les connexions bureautiques **IBCONNECT** sont la solution idéale pour équiper tout lieu de travail de façon confortable et fonctionnelle de raccords pour des applications voix, données et multimédia ainsi que des prises électriques nécessaires. Une solution pour chaque application.

Grâce aux connexions bureautiques **IBCONNECT**, divers postes de travail, meubles de bureau et installations multimédia professionnelles répondent aux besoins actuels et futurs.



**Box** (page 215-217)



**Cubo** (page 214)



**Cap** (page 213)



**Intro** (page 212)



**Prisma N** (page 218-219)



**Top** (page 212)



**Meeting** (page 212)



**Unit** (page 220)



**Lumen** (page 222)



**PDC N** (page 212)



**Orgatech** (page 221)

# Connexions bureautiques: INTRO, PDC, TOP, MEETING

---



## INTRO

---

L'INTRO est la solution d'encastrement la plus compacte pour installer des prises de courant et des raccordements de données et multimédia.



## PDC – point de distribution 230V

---

En fonction de vos besoins, le PDC devient un point de distribution électrique pour une alimentation 230V.



## PDC – point de distribution RJ45

---

En fonction de vos besoins, le PDC devient un point de distribution pour la transmission de données.



## TOP

---

Boîtier de raccordement intégré à commande électrique. Les prises de courant et les raccordements de données et multimédia peuvent être combinés d'un côté.



## MEETING

---

Boîtier de raccordement intégré à commande électrique. Les prises de courant et les raccordements de données et multimédia peuvent être combinés des deux côtés.

**Configuration des types susmentionnés en fonction de vos besoins.**

# Connexions bureautiques: CAP

	type	référence	page catal.	groupe d'articles	prix en €
	<b>CAP</b> Aluminium	blanc	44201004/1	2403	72,97/pc.
	<b>CAP</b> Aluminium	noir	44201004/2	2403	72,97/pc.
	<b>CAP</b> Aluminium	gris	44201004/4	2403	72,97/pc.
	<b>CAP Plus</b> Aluminium	noir	44202004/2	2403	91,29/pc.
	<b>CAP Plus</b> Aluminium	gris	44202004/4	2403	91,29/pc.

# Connexions bureautiques: CUBO

	type	référence	page catal.	groupe d'articles	prix en €
	<b>CUBO</b> 3 prises de courant + 1 espace vide (45x45) Profilé en aluminium laqué en blanc et mécanismes blancs	32102001F1		2401	52,26/pc.
	<b>CUBO</b> 3 prises de courant + 1 espace vide (45x45) Profilé en aluminium laqué en noir et mécanismes en anthracite	32102001F3		2401	52,26/pc.
	<b>CUBO</b> 3 prises de courant + 2 espaces vides (45x45) Profilé en aluminium laqué en blanc et mécanismes blancs	32102002F1		2401	56,40/pc.
	<b>CUBO</b> 3 prises de courant + 2 espaces vides (45x45) Profilé en aluminium laqué en noir et mécanismes en anthracite	32102002F3		2401	56,40/pc.
	<b>CUBO</b> 4 prises de courant + support Profilé en aluminium laqué en blanc et mécanismes blancs	33106003F1		2401	68,70/pc.
	<b>CUBO</b> 4 prises de courant + support Profilé en aluminium laqué en noir et mécanismes en anthracite	33106003F3		2401	68,70/pc.



# Connexions bureautiques: BOX

	type	référence	page catal.	groupe d'articles	prix en €
	<b>BOX 4 éléments</b> Aluminium	blanc	44101004/1	2402	88,33/pc.
	<b>BOX 4 éléments</b> Aluminium	noir	44101004/2	2402	88,33/pc.
	<b>BOX 4 éléments</b> Aluminium	gris	44101004/4	2402	88,33/pc.
	<b>BOX 6 éléments</b> Aluminium	blanc	44101006/1	2402	99,27/pc.
	<b>BOX 6 éléments</b> Aluminium	noir	44101006/2	2402	99,27/pc.
	<b>BOX 6 éléments</b> Aluminium	gris	44101006/4	2402	99,27/pc.

# Connexions bureautiques: BOX

	type	référence	page catal.	groupe d'articles	prix en €
	<b>CUBOBOX4</b> 4 prises de courant Profilé en aluminium laqué en blanc et mécanismes blancs	34101003F1		2402	49,82/pc.
	<b>CUBOBOX4</b> 4 prises de courant Profilé en aluminium laqué en noir et mécanismes anthracite	34101003F3		2402	49,82/pc.
	<b>CUBOBOX4</b> 3 prises de courant + 1 espace vide (45x45) Profilé en aluminium laqué en blanc et mécanismes blancs	32112001F1		2402	48,75/pc.
	<b>CUBOBOX4</b> 3 prises de courant + 1 espace vide (45x45) Profilé en aluminium laqué en noir et mécanismes en anthracite	32112001F3		2402	48,75/pc.
	<b>CUBOBOX4</b> 2 prises de courant + 2 espaces vides (45x45) Profilé en aluminium laqué en blanc et mécanismes blancs	32112002F1		2402	44,32/pc.
	<b>CUBOBOX4</b> 2 prises de courant + 2 espaces vides (45x45) Profilé en aluminium laqué en noir et mécanismes en anthracite	32112002F3		2402	44,32/pc.





# Connexions bureautiques: BOX

	type	référence	page catal.	groupe d'articles	prix en €
	<b>CUBOBOX6</b> 6 prises de courant Profilé en aluminium laqué en blanc et mécanismes blancs	34101005F1		2402	63,37/pc.
	<b>CUBOBOX6</b> 6 prises de courant Profilé en aluminium laqué en noir et mécanismes en anthracite	34101005F3		2402	63,37/pc.
	<b>CUBOBOX6</b> 3 prises de courant + 3 espaces vides (45x45) Profilé en aluminium laqué en blanc et mécanismes blancs	32112004F1		2402	54,60/pc.
	<b>CUBOBOX6</b> 3 prises de courant + 3 espaces vides (45x45) Profilé en aluminium laqué en noir et mécanismes en anthracite	32112004F3		2402	54,60/pc.
	<b>CUBOBOX6</b> 4 prises de courant + 2 espaces vides (45x45) Profilé en aluminium laqué en blanc et mécanismes blancs	32112005F1		2402	57,71/pc.
	<b>CUBOBOX6</b> 4 prises de courant + 2 espaces vides (45x45) Profilé en aluminium laqué en noir et mécanismes en anthracite	32112005F3		2402	57,71/pc.





# Connexions bureautiques: PRISMA

	type	référence	page catal.	groupe d'articles	prix en €
	<b>PRISMA</b> 3 prises de courant + 1 espace vide (45x45) Coffret blanc, profilé noir et mécanismes en anthracite	blanc 26103001F1		2413	148,88/pc.
	<b>PRISMA</b> 3 prises de courant + 1 espace vide (45x45) Coffret noir, profilé noir et mécanismes en anthracite	anthracite 26103001F3		2413	148,88/pc.
	<b>PRISMA</b> 2 prises de courant + 2 espaces vides (45x45) Coffret blanc, profilé noir et mécanismes en anthracite	blanc 26103002F1		2413	148,88/pc.
	<b>PRISMA</b> 2 prises de courant + 2 espaces vides (45x45) Coffret noir, profilé noir et mécanismes en anthracite	anthracite 26103002F3		2413	148,88/pc.
	<b>PRISMA</b> 3 prises de courant + 1 x chargeur USB 5V/2A + 1 plaquette de montage 1 x RJ45 (connecteurs non inclus) Coffret blanc, profilé noir et mécanismes en anthracite	blanc 26103003F1		2413	185,99/pc.
	<b>PRISMA</b> 3 prises de courant + 1 x chargeur USB 5V/2A + 1 plaquette de montage 1 x RJ45 (connecteurs non inclus) Coffret noir, profilé noir et mécanismes en anthracite	anthracite 26103003F3		2413	185,99/pc.

# Connexions bureautiques: PRISMA

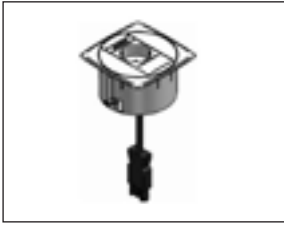
	type	référence	page catal.	groupe d'articles	prix en €
	<b>PRISMA SURFACE</b>				
		3 prises de courant + 1 x chargeur USB 5V/2A + 1 plaquette de montage 1 x RJ45 (connecteurs non inclus)	blanc	26103006F1	2413
Coffret blanc, profilé noir et mécanismes en anthracite					
	<b>PRISMA SURFACE</b>				
		3 prises de courant + 1 x chargeur USB 5V/2A + 1 plaquette de montage 1 x RJ45 (connecteurs non inclus)	anthracite	26103006F3	2413
Coffret noir, profilé noir et mécanismes en anthracite					
	<b>PRISMA SUPPORT</b>				
		2 prises de courant + 1 x chargeur USB 5V/2A	blanc	26106005F1	2413
Coffret blanc, profilé noir et mécanismes en anthracite					
	<b>PRISMA SUPPORT</b>				
		2 prises de courant + 1 x chargeur USB 5V/2A	anthracite	26106005F3	2413
Coffret noir, profilé noir et mécanismes en anthracite					

# Connexions bureautiques: UNIT

	type	référence	page catal.	groupe d'articles	prix en €
	<b>UNIT pour table comme passage de câbles</b>				
	Matière synthétique				
	blanc	46100001/1		2411	23,41/pc.
	gris	46100001/3		2411	23,41/pc.
	<b>UNIT pour table avec prise de courant et plaque aveugle 22,5 mm</b>				
	Matière synthétique				
	blanc	46101001F1		2411	47,15/pc.
	gris	46101001F3		2411	47,15/pc.
	<b>UNIT pour table avec prise de courant et plaque de montage pour RJ45</b>				
	Matière synthétique				
	blanc	46102001F1		2411	53,23/pc.
	gris	46102001F3		2411	53,23/pc.
	<b>UNIT pour table avec prise de courant et chargeur USB 5V/2A</b>				
	Matière synthétique				
	blanc	46203002F1		2411	80,63/pc.
	gris	46203002F3		2411	80,63/pc.
	<b>UNIT pour sol rehaussé avec adaptateur pour ORGATECH</b>				
	Matière synthétique				
	blanc	46100002/1		2411	24,15/pc.
	gris	46100002/3		2411	24,15/pc.

# Connexions bureautiques: ORGATECH



	type	référence	page catal.	groupe d'articles	prix en €
	<b>ORGATECH L= 800 mm + 5 fixations</b>				
	Matière synthétique				
	transparent	92114001		2412	44,81/set
	blanc	92114001/1		2412	37,58/set
	gris	92114001/3		2412	37,58/set
	<b>ORGATECH 2 anneaux + 2 fixations</b>				
	Matière synthétique				
	transparent	92114007		2412	20,37/set
	<b>ORGATECH embase + 4 anneaux</b>				
	Acier laqué en noir				
	transparent	92114002		2412	17,74/pc.
	blanc	92114002/1		2412	16,95/pc.
	gris	92114002/3		2412	16,95/pc.
	<b>ORGATECH dérivation (1 set = 5 dérivation)</b>				
	Matière synthétique				
		92114003		2412	15,70/set
	<b>ORGATECH fixation (1 set = 5 fixations)</b>				
	Matière synthétique				
		92114004		2412	14,90/set
	<b>Adaptateur femelle pour Orgatech (1 set = 5 pièces)</b>				
	Matière synthétique				
	blanc	92114005/1		2412	10,21/set
	anthracite	92114005/3		2412	10,21/set
	<b>Adaptateur mâle pour Orgatech (1 set = 5 pièces)</b>				
	Matière synthétique				
	blanc	92114006/1		2412	10,21/set
	anthracite	92114006/3		2412	10,21/set



# Connexions bureautiques: LUMEN

	type	référence	page catal.	groupe d'articles	prix en €
	<b>LUMEN</b>				
	1 tube fluorescent 18W + 2 prises de courant + interrupteur				
	Aluminium	gris	74109001F3	2405	183,27/pc.
	<b>LUMEN</b>				
	1 tube fluorescent 18W + 2 prises de courant + interrupteur + entrée et sortie				
	Aluminium	gris	74109002F3	2405	192,42/pc.
	<b>LUMEN</b>				
	1 tube fluorescent 36 W + 2 prises de courant + interrupteur				
	Aluminium	gris	74109003F3	2405	221,61/pc.
	<b>LUMEN 1</b>				
	1 tube fluorescent 36 W + 2 prises de courant + interrupteur + entrée et sortie				
	Aluminium	gris	74109004F3	2405	230,64/pc.
	<b>LUMEN</b>				
	1 tube fluorescent 58W + 3 prises de courant + interrupteur				
	Aluminium	gris	74109005F3	2405	274,83/pc.
	<b>LUMEN</b>				
	1 tube fluorescent 58W + 3 prises de courant + interrupteur + entrée et sortie				
	Aluminium	gris	74109006F3	2405	274,16/pc.

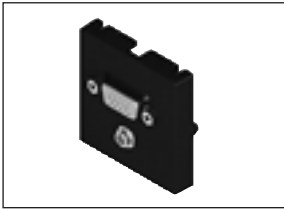
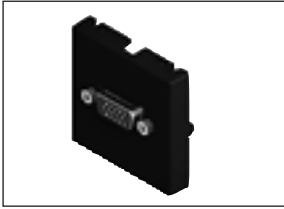
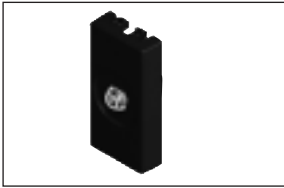
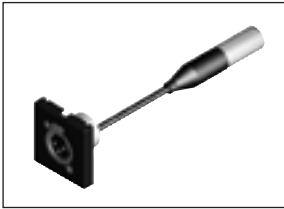
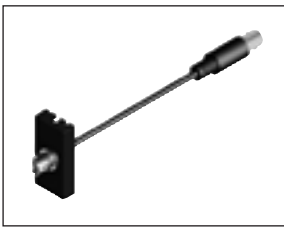
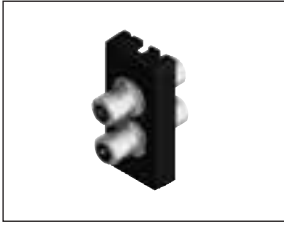
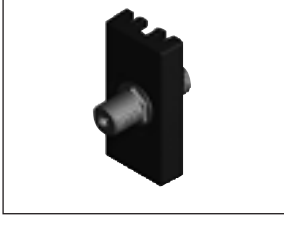
# Connexions bureautiques: plaques de montage

	type	référence	page catal.	groupe d'articles	prix en €
	<b>Plaque de montage (45 x 45): 1 x module VGA + module stéréo</b>				
	blanc	91113001/1		2407	sur demande
	anthracite	91113001/3		2407	sur demande
	<b>Plaque de montage (45 x 45): 1 x module VGA</b>				
	blanc	91113002/1		2407	sur demande
	anthracite	91113002/3		2407	sur demande
	<b>Plaque de montage (45 x 22.5 ): 1 x module stéréo</b>				
	blanc	91113003/1		2407	10,73/pc.
	anthracite	91113003/3		2407	10,73/pc.
	<b>Plaque de montage (45 x 45): 1 x XLR module 3 broches</b>				
	blanc	91113004/1		2407	32,30/pc.
	anthracite	91113004/3		2407	32,30/pc.
	<b>Plaque de montage (45 x 22.5): 1 x module BNC</b>				
	blanc	91113005/1		2407	12,89/pc.
	anthracite	91113005/3		2407	12,89/pc.
	<b>Plaque de montage (45 x 22.5): 1 x module RCA</b>				
	blanc	91113006/1		2407	10,54/pc.
	anthracite	91113006/3		2407	10,54/pc.
	<b>Plaque de montage (45 x 22.5): 1 x module F</b>				
	blanc	91113007/1		2407	3,30/pc.
	anthracite	91113007/3		2407	3,30/pc.
	<b>Plaque de montage (45 x 22.5): 1 x module USB 2.0 A/A</b>				
	blanc	91113009/1		2407	16,20/pc.
	anthracite	91113009/3		2407	16,20/pc.

# Connexions bureautiques: plaques de montage

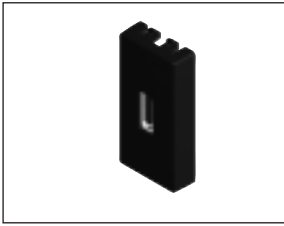
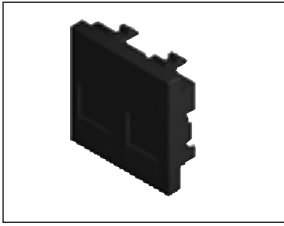
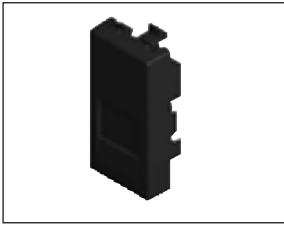
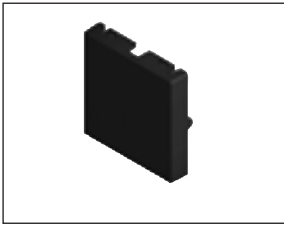
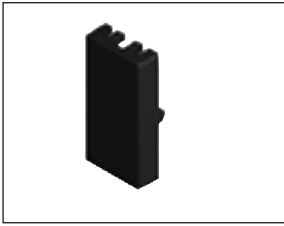
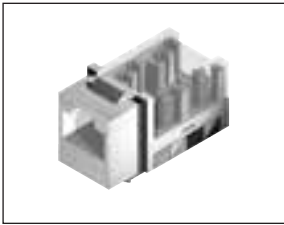
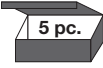
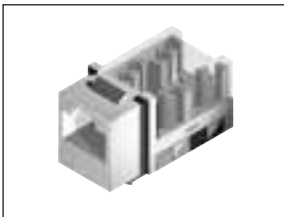
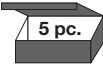
	type	référence	page catal.	groupe d'articles	prix en €
	<b>Plaque de montage (45 x 22.5): 1 x module HDMI</b>				
	blanc	91113010/1		2407	45,12/pc.
	anthracite	91113010/3		2407	45,12/pc.
	<b>Plaque de montage (45 x 45): 2 x module RJ45 (connecteurs non inclus)</b>				
	blanc	91113011/1		2407	5,26/pc.
	anthracite	91113011/3		2407	5,26/pc.
	<b>Plaque de montage (45 x 22.5): 1 x module RJ 45 (connecteur non inclus)</b>				
	blanc	91113012/1		2407	4,26/pc.
	anthracite	91113012/3		2407	4,26/pc.
	<b>Plaque de montage (45 x 45): aveugle</b>				
	blanc	91113013/1		2407	0,92/pc.
	anthracite	91113013/3		2407	0,92/pc.
	<b>Plaque de montage (45 x 22.5): aveugle</b>				
	blanc	91113014/1		2407	0,78/pc.
	anthracite	91113014/3		2407	0,78/pc.
	<b>Connecteur CAT5e femelle</b>				
	RJ45	91112001		2407	6,89/pc.
					
	<b>Connecteur CAT6 femelle</b>				
	RJ45	91112002		2407	10,73/pc.
					

# Connexions bureautiques: accessoires

	type	référence	page catal.	groupe d'articles	prix en €
	<b>Connecteur CAT5e femelle/femelle</b>				
	RJ45	91112003		2407	4,72/pc.
	<b>Connecteur CAT6 femelle/femelle</b>				
	RJ45	91112004		2407	5,31/pc.
	<b>Connecteur en T GST 18T</b>				
	noir	91111001/2		2407	4,46/pc.
	<b>Connecteur GST18 mâle, 3 pôles</b>				
	noir	91111002/2		2407	2,43/pc.
	rouge	91111002/6		2407	2,59/pc.
	<b>Connecteur GST18 femelle, 3 pôles</b>				
	noir	91111003/2		2407	2,43/pc.
	rouge	91111003/6		2407	2,59/pc.
	<b>Connexion intermédiaire GST 18</b>				
	noir	91111005/2		2407	3,99/pc.
	<b>Distributeur in: 1 GST18, mâle noir; out: 6GST18, femelle noir</b>				
	Aluminium				
	noir	33105001		2401	82,37/pc.
	<b>Distributeur in: 1 GST18, mâle noir et 1 GST18 mâle rouge; out: 6 GST18, femelle noir et 6 GST18 femelle rouge</b>				
	Aluminium				
	noir/rouge	33105002		2401	143,76/pc.

## Connexions bureautiques: accessoires

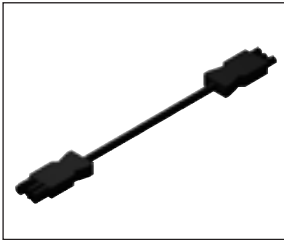
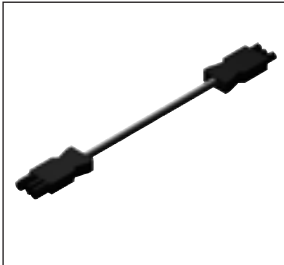
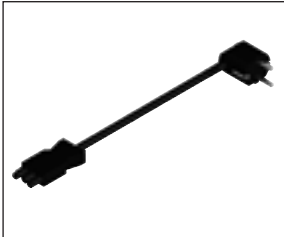
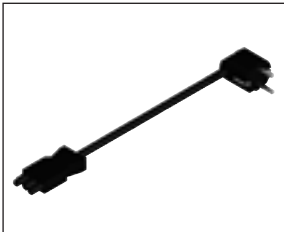
	type	référence	page catal.	groupe d'articles	prix en €
	<b>Câble de rallonge GST18 3-polaire mâle / GST18 3-polaire femelle; câble HO5VV-F 3G2,5</b>				
	1m noir	91110008/2		2407	17,97/pc.
	1m rouge	91110008/6		2407	22,99/pc.
	2m noir	91110009/2		2407	20,42/pc.
	2m rouge	91110009/6		2407	25,23/pc.
	3m noir	91110010/2		2407	24,81/pc.
	3m rouge	91110010/6		2407	30,88/pc.
	<b>Câble de rallonge GST18 3-polaire mâle / GST18 3-polaire femelle, câble exempt d'halogènes JZ500 HMH 3G2,5</b>				
	1m noir	91110020/2		2407	20,91/pc.
	1m rouge	91110020/6		2407	25,86/pc.
	2m noir	91110012/2		2407	24,59/pc.
	2m rouge	91110012/6		2407	30,65/pc.
	3m noir	91110014/2		2407	30,58/pc.
	3m rouge	91110014/6		2407	32,75/pc.
	<b>Câble de raccordement GST 18 3-polaire mâle ; câble HO5VV-F 3G2,5 ; fiche</b>				
	2m noir	91110006F2		2407	18,55/pc.
	2m rouge	91110006F6		2407	23,48/pc.
	3m noir	91110007F2		2407	23,43/pc.
	3m rouge	91110007F6		2407	29,33/pc.
	<b>Câble de raccordement GST 18 3-polaire mâle ; câble exempt d'halogènes JZ-500 HMH 3G2,5 ; fiche</b>				
	2m noir	91110016F2		2407	24,81/pc.
	2m rouge	91110016F6		2407	30,39/pc.
	3m noir	91110018F2		2407	29,73/pc.
	3m rouge	91110018F6		2407	37,11/pc.

# Index

référence	prix en €	page	référence	prix en €	page	référence	prix en €	page	référence	prix en €	page
40611	2,30/pc.	44	709019	3,33/pc.	16	716196	233,58/pc.	18	718181	265,95/pc.	18
40616	3,08/pc.	44	709020	6,06/pc.	16	716197	248,60/pc.	18	718182	275,13/pc.	18
40631	6,65/pc.	44	709021	5,53/pc.	16	716198	253,40/pc.	18	718183	357,04/pc.	18
70510	2,63/pc.	32	709031	160,30/m	11	716199	268,43/pc.	18	718243	15,69/pc.	12
80100	1,51/pc.	35	709050	2,42/pc.	24	716200	617,42/pc.	18	718249	127,09/pc.	10
80200	4,10/pc.	45	709051	2,42/pc.	24	716209	346,29/pc.	18	718250	171,89/pc.	10
80201	7,90/pc.	45	709052	2,68/pc.	24	716210	347,66/pc.	18	718251	212,92/pc.	10
80202	3,37/pc.	45	709053	2,68/pc.	24	716212	355,84/pc.	18	718253	181,56/pc.	12
80602	2,60/pc.	44	709054	2,68/pc.	24	716213	368,13/pc.	18	718409	23,91/pc.	15
80603	4,21/pc.	44	709055	3,28/pc.	24	716214	376,33/pc.	18	718473	1,12/pc.	32
80604	5,15/pc.	44	709056	3,28/pc.	24	716215	387,26/pc.	18	718507	4,14/pc.	23
80605	8,60/pc.	44	709057	3,28/pc.	24	716216	545,72/pc.	18	718508	4,47/pc.	23
80606	10,90/pc.	44	709058	3,28/pc.	24	716241	402,98/pc.	19	718509	4,53/pc.	23
80607	16,91/pc.	44	709795	85,55/m	11	716243	414,59/pc.	19	718510	4,87/pc.	23
80610	11,18/pc.	44	709798	113,73/m	11	716244	424,82/pc.	19	718511	5,08/pc.	23
81501	3,08/pc.	45	709799	286,68/pc.	10	716245	443,95/pc.	19	718512	5,26/pc.	23
81503	3,75/pc.	45	709801	18,65/pc.	13	716246	445,98/pc.	19	718513	5,48/pc.	23
81504	1,60/pc.	36	711205	26,19/pc.	21	716247	753,34/pc.	19	718514	5,54/pc.	23
81512	3,57/pc.	36	712015	109,24/m	6	716255	566,88/pc.	20	718515	6,53/pc.	23
81522	4,34/pc.	36	712017	112,11/m	6	716257	580,54/pc.	20	718516	4,74/pc.	24
81532	4,96/pc.	36	712018	118,77/m	6	716258	590,12/pc.	20	718517	4,87/pc.	24
81542	5,71/pc.	36	712019	114,55/m	6	716259	606,48/pc.	20	718518	5,07/pc.	24
81550	6,78/pc.	36	712020	120,13/m	6	716260	607,17/pc.	20	718519	5,54/pc.	24
81552	6,92/pc.	36	712465	197,36/pc.	7	716261	990,35/pc.	20	718520	6,59/pc.	24
81562	8,19/pc.	36	712639	14,60/pc.	26	716389	218,32/pc.	19	718521	7,20/pc.	24
81572	8,90/pc.	36	712640	15,82/pc.	26	716390	222,38/pc.	19	718562	44,20/m	5
81582	10,50/pc.	36	712642	16,08/pc.	26	716391	224,28/pc.	19	718563	44,20/m	5
81710	14,50/pc.	43	712643	18,90/pc.	26	716392	225,25/pc.	19	718564	46,07/m	5
81712	10,52/pc.	43	712644	22,76/pc.	26	716393	257,22/pc.	19	718565	48,10/m	5
81715	14,82/pc.	43	712645	24,36/pc.	26	716400	282,12/m	6	718566	51,65/m	5
81720	15,92/pc.	43	712668	6,33/pc.	27	716640	4,48/pc.	21	718567	53,78/m	5
81722	12,65/pc.	43	713153	11,30/pc.	12	716792	4,57/m	9	718568	164,30/m	5
81730	21,55/pc.	43	713173	35,64/pc.	14	716792	4,57/m	115	718572	19,60/m	5
81731	11,21/pc.	43	713177	17,84/pc.	13	716793	4,57/m	9	718573	24,15/m	5
81732	16,38/pc.	43	713178	18,83/pc.	13	716794	6,20/pc.	28	718574	27,47/m	5
81733	24,53/pc.	43	713203	15,86/pc.	16	716795	8,19/pc.	28	718575	31,97/m	5
81740	25,75/pc.	43	713204	15,22/pc.	16	716796	8,88/pc.	28	718576	35,24/m	5
81742	22,13/pc.	43	713684	0,77/m	23	716821	4,73/pc.	45	718618	24,22/pc.	21
81752	28,90/pc.	43	713685	0,77/m	23	716824	5,37/pc.	22	718624	48,35/pc.	7
81762	36,85/pc.	43	713686	2,29/m	23	717001	23,43/pc.	8	718625	52,35/pc.	7
81977	0,07/pc.	46	713687	2,56/m	23	717191	15,16/pc.	9	718626	60,15/pc.	7
84400	1,41/pc.	43	713694	0,98/pc.	28	717192	16,97/pc.	9	718627	68,12/pc.	7
84901	1,72/pc.	44	715675	14,70/pc.	12	717193	17,83/pc.	9	718628	76,02/pc.	7
86510	12,62/pc.	43	715723	65,51/pc.	10	717194	24,91/pc.	9	718632	3,79/pc.	28
86520	14,82/pc.	43	715723	65,51/pc.	44	717195	29,30/pc.	9	718640	14,29/pc.	12
86530	16,74/pc.	43	715724	79,68/pc.	10	717196	21,09/pc.	9	718643	32,24/pc.	20
86540	18,12/pc.	43	715724	79,68/pc.	44	717196	21,09/pc.	44	718660	440,81/pc.	25
88520	1,17/pc.	36	715725	100,92/pc.	10	717196	21,09/pc.	114	718718	326,59/pc.	10
88540	0,36/pc.	37	715725	100,92/pc.	44	717197	24,10/pc.	9	718719	390,47/pc.	10
88550	0,98/pc.	36	715726	131,73/pc.	10	717197	24,10/pc.	44	718720	515,72/pc.	10
88701	5,99/m	35	715726	131,73/pc.	44	717197	24,10/pc.	114	718721	576,16/pc.	10
88705	0,48/pc.	35	715727	165,51/pc.	10	717198	27,36/pc.	9	718808	113,73/m	11
88712	5,60/pc.	35	715727	165,51/pc.	44	717198	27,36/pc.	44	718835	10,94/pc.	22
88722	5,93/pc.	35	715728	274,06/pc.	10	717198	27,36/pc.	114	718849	33,99/pc.	13
88732	6,40/pc.	35	715728	274,06/pc.	44	717199	31,40/pc.	9	718850	137,34/pc.	13
88742	6,77/pc.	35	715735	1,55/pc.	28	717199	31,40/pc.	44	718851	151,91/pc.	13
88752	7,73/pc.	35	715736	2,02/pc.	28	717199	31,40/pc.	114	718903	158,09/pc.	14
89077	0,14/pc.	46	715879	19,13/m	10	717200	36,07/pc.	9	718904	16,18/pc.	14
89177	0,21/pc.	46	716066	204,60/pc.	17	717200	36,07/pc.	44	720517	225,25/pc.	19
705093	29,20/m	11	716067	204,60/pc.	17	717618	20,07/pc.	13	720536	131,54/pc.	13
705304	9,97/pc.	14	716069	217,07/pc.	17	717637	103,81/pc.	25	720761	16,63/pc.	8
705392	22,43/pc.	14	716070	219,24/pc.	17	717640	26,76/pc.	14	720762	17,36/pc.	8
705394	25,71/pc.	14	716071	234,46/pc.	17	717641	35,26/pc.	14	720763	19,00/pc.	8
705395	27,61/pc.	14	716072	248,78/pc.	17	717642	52,53/pc.	14	720764	21,96/pc.	8
705396	32,24/pc.	14	716073	512,20/pc.	17	717982	109,24/m	6	720765	29,30/pc.	8
705397	32,76/pc.	14	716179	299,12/pc.	17	717983	112,11/m	6	720766	33,77/pc.	8
706415	12,49/set	20	716180	320,07/pc.	17	717984	114,55/m	6	720815	88,74/pc.	20
707511	9,23/pc.	8	716182	343,23/pc.	17	717985	118,77/m	6	720824	23,96/pc.	15
707609	65,22/pc.	19	716183	373,33/pc.	17	717986	120,13/m	6	721101	9,87/pc.	12
707748	99,27/pc.	17	716184	409,28/pc.	17	718176	231,57/pc.	18	721102	11,14/m	10
708001	20,38/pc.	19	716185	415,22/pc.	17	718177	241,72/pc.	18	721105	10,17/pc.	16
709017	15,18/pc.	15	716193	221,97/pc.	18	718179	247,69/pc.	18	721106	11,73/pc.	16
709018	13,71/pc.	15	716194	225,38/pc.	18	718180	261,96/pc.	18	721114	68,30/pc.	17

# Index

référence	prix en €	page	référence	prix en €	page	référence	prix en €	page	référence	prix en €	page
721115	6,14/pc.	14	725566	sur demande	9	727372	sur demande	18	732265	33,34/m	26
721119	12,04/pc.	13	725567	sur demande	10	727373	sur demande	18	732266	42,33/m	26
721122	15,73/pc.	15	725568	sur demande	10	727374	sur demande	18	732267	54,34/m	26
721869	12,41/pc.	8	725569	sur demande	10	727375	sur demande	18	732268	55,34/m	26
721870	16,92/pc.	8	725570	sur demande	10	727376	sur demande	6	732269	66,35/m	26
721871	18,13/pc.	8	725571	sur demande	10	727377	sur demande	6	732270	146,67/m	26
721872	24,03/pc.	8	725572	sur demande	10	727378	sur demande	6	732291	sur demande	26
721873	26,30/pc.	8	725573	sur demande	12	727379	sur demande	6	732292	sur demande	26
721960	98,12/m	5	725574	sur demande	10	727380	sur demande	6	732293	sur demande	26
721961	443,64/pc.	17	725575	sur demande	10	727381	sur demande	6	732294	sur demande	26
721964	336,73/pc.	18	725576	sur demande	10	727382	sur demande	5	732295	sur demande	26
723057	591,41/pc.	17	725577	sur demande	10	727383	sur demande	5	732296	sur demande	26
723061	150,67/pc.	17	725578	sur demande	10	727384	sur demande	5	732322	139,67/pc.	27
723062	159,89/pc.	17	725579	sur demande	10	727385	sur demande	5	732323	154,50/pc.	27
723063	162,77/pc.	17	725582	sur demande	28	727386	sur demande	5	732324	178,78/pc.	27
723064	191,05/pc.	17	725590	sur demande	23	727387	sur demande	5	732325	218,32/pc.	27
723065	198,25/pc.	17	725591	sur demande	23	727582	13,64/pc.	9	732326	260,21/pc.	27
723212	40,71/pc.	18	725592	sur demande	23	727583	15,81/pc.	9	732327	281,82/pc.	27
723260	812,13/pc.	17	725593	sur demande	22	727584	18,69/pc.	9	732345	156,42/pc.	27
723432	13,33/pc.	7	725594	sur demande	22	727585	23,37/pc.	9	732346	190,42/pc.	27
723433	13,48/pc.	7	725618	sur demande	7	727586	26,32/pc.	9	732347	207,38/pc.	27
723433	13,48/pc.	114	725619	sur demande	7	727777	36,99/pc.	6	732348	222,48/pc.	27
723434	13,83/pc.	7	725620	sur demande	7	727778	40,39/pc.	6	732349	258,18/pc.	27
723434	13,83/pc.	114	725621	sur demande	7	727779	45,04/pc.	6	732350	286,08/pc.	27
723435	15,63/pc.	7	725622	sur demande	7	727780	50,00/pc.	6	732475	238,77/pc.	22
723436	15,92/pc.	7	725623	sur demande	7	727781	51,41/pc.	6	732476	247,43/pc.	22
723436	15,92/pc.	114	725624	sur demande	7	728584	7,98/pc.	27	732477	281,82/pc.	22
723437	25,16/pc.	7	725625	sur demande	7	728586	sur demande	27	732478	301,14/pc.	22
723437	25,16/pc.	114	725636	sur demande	13	728595	sur demande	11	732479	307,63/pc.	22
723438	33,27/pc.	7	725751	sur demande	14	728596	sur demande	28	732481	sur demande	22
723439	34,94/pc.	7	725760	sur demande	15	728598	sur demande	28	732482	sur demande	22
723450	55,29/pc.	13	725763	sur demande	7	728642	12,88/pc.	23	732483	sur demande	22
723451	55,88/pc.	13	725774	sur demande	16	728643	sur demande	23	732484	sur demande	22
723925	sur demande	9	725775	sur demande	16	728651	sur demande	23	732485	sur demande	22
723926	sur demande	9	725776	sur demande	21	728652	sur demande	23	732983	20,65/pc.	22
723938	0,59/pc.	9	725777	sur demande	21	728653	28,77/pc.	23	733258	1,34/pc.	33
723938	0,59/pc.	115	725785	11,98/pc.	22	728654	31,08/pc.	23	733487	11,01/pc.	12
723939	sur demande	9	726433	sur demande	8	728767	sur demande	20	734171	42,64/pc.	15
724806	4,74/pc.	9	726434	sur demande	8	728883	7,93/pc.	45	734172	52,27/pc.	15
724806	4,74/pc.	46	726435	sur demande	8	729217	6,12/pc.	26	734173	64,12/pc.	15
724807	sur demande	9	726436	sur demande	8	730188	7,99/pc.	26	734174	73,94/pc.	15
725065	11,13/m	23	726437	sur demande	8	730190	sur demande	26	734488	19,60/m	5
725066	12,13/m	23	726438	sur demande	8	730192	268,92/pc.	22	734489	24,15/m	5
725067	14,67/m	23	726484	sur demande	13	730193	279,65/pc.	22	734490	27,47/m	5
725083	3,40/pc.	46	726485	sur demande	13	730194	311,91/pc.	22	734491	31,97/m	5
725096	64,12/pc.	18	726668	0,99/pc.	16	730195	344,23/pc.	22	734492	35,24/m	5
725350	38,22/m	5	727125	68,19/pc.	7	730196	381,89/pc.	22	734494	36,52/m	5
725350	38,22/m	114	727126	71,85/pc.	7	730245	24,53/pc.	21	734495	38,15/m	5
725351	38,22/m	5	727127	79,18/pc.	7	731717	24,80/m	11	734496	40,84/m	5
725351	38,22/m	114	727128	84,91/pc.	7	731719	29,20/m	11	734497	44,33/m	5
725352	39,53/m	5	727195	sur demande	18	731721	24,80/m	11	734498	46,79/m	5
725352	39,53/m	114	727197	sur demande	17	731727	sur demande	11	734713	79,06/pc.	15
725353	41,18/m	5	727340	sur demande	17	731745	26,30/pc.	21	734744	6,15/pc.	28
725353	41,18/m	114	727346	sur demande	17	731746	29,24/pc.	21	734864	6,08/pc.	28
725354	43,34/m	5	727347	sur demande	17	731747	17,53/pc.	22	734983	5,99/pc.	28
725355	45,62/m	5	727348	sur demande	17	731748	16,18/m	23	734986	sur demande	28
725356	107,31/m	5	727349	sur demande	17	731749	21,73/m	23	735446	3,33/pc.	16
725357	6,64/pc.	10	727350	sur demande	17	731750	31,17/m	23	735977	11,27/m	33
725358	7,51/pc.	10	727351	sur demande	17	731791	16,18/pc.	13	735978	13,74/m	33
725359	8,87/pc.	10	727352	sur demande	17	731793	sur demande	13	735979	18,04/m	33
725360	11,53/pc.	10	727353	sur demande	17	731837	138,48/pc.	20	735980	22,32/m	33
725361	15,05/pc.	10	727354	sur demande	17	731914	sur demande	20	735981	31,18/m	33
725362	10,32/pc.	12	727355	sur demande	17	731994	4,15/pc.	16	735982	39,68/m	33
725363	15,00/pc.	15	727356	sur demande	17	732151	27,90/m	16	735988	8,33/m	32
725557	sur demande	9	727357	sur demande	17	732177	9,42/pc.	12	735989	10,88/m	32
725558	sur demande	9	727358	sur demande	18	732216	13,03/m	26	735990	13,45/m	32
725559	sur demande	9	727359	sur demande	18	732217	16,01/m	26	735991	16,23/m	32
725560	sur demande	9	727360	sur demande	18	732218	21,27/m	26	735992	21,66/m	32
725561	sur demande	9	727361	sur demande	18	732219	31,13/m	26	735993	28,07/m	32
725562	sur demande	9	727362	sur demande	18	732220	36,17/m	26	735998	440,81/pc.	25
725563	sur demande	9	727363	sur demande	18	732221	49,83/m	26	736440	170,31/pc.	24
725564	sur demande	9	727370	sur demande	18	732222	123,33/m	26	736441	173,75/pc.	24
725565	sur demande	9	727371	sur demande	18	732264	32,33/m	26	736442	175,92/pc.	24



# Index

référence	prix en €	page	référence	prix en €	page	référence	prix en €	page	référence	prix en €	page
736443	178,25/pc.	24	781445	309,83/pc.	27	791066	20,72/pc.	8	8135009	10,52/pc.	43
736444	189,73/pc.	24	783155	19,60/m	5	791067	21,51/pc.	8	8140709	6,96/pc.	43
736445	193,21/pc.	24	783156	24,15/m	5	791068	21,90/pc.	8	8141009	7,80/pc.	43
736446	196,64/pc.	24	783157	27,47/m	5	791092	3,79/pc.	8	8141209	8,50/pc.	43
736447	215,98/pc.	24	783158	31,97/m	5	791199	15,93/pc.	14	8141509	9,28/pc.	43
736448	219,45/pc.	24	783159	35,24/m	5	791350	46,27/pc.	19	8142009	10,31/pc.	43
736449	222,82/pc.	24	783374	sur demande	15	791412	4,17/pc.	6	8142509	12,22/pc.	43
736450	254,76/pc.	24	783460	20,44/pc.	21	791412	4,17/pc.	44	8143009	13,72/pc.	43
736451	258,24/pc.	24	783461	26,30/pc.	21	791413	5,80/pc.	6	8143309	14,79/pc.	43
736452	261,66/pc.	24	784066	sur demande	6	791413	5,80/pc.	44	8161003	7,73/m	36
736453	291,48/pc.	24	784067	sur demande	6	791414	7,05/pc.	6	8161103	10,04/m	36
736454	294,85/pc.	24	784068	sur demande	6	791414	7,05/pc.	44	8161503	13,03/m	36
736455	297,10/pc.	24	784069	sur demande	6	791415	11,40/pc.	6	8162003	11,53/m	36
736456	26,34/pc.	25	784070	sur demande	6	791415	11,40/pc.	44	8163003	16,01/m	36
736609	30,68/m	32	784073	39,20/pc.	32	792873	sur demande	19	8164003	18,54/m	36
736610	38,21/m	32	784074	41,45/pc.	32	792875	sur demande	19	8164303	21,27/m	36
736619	44,30/m	33	784075	43,69/pc.	32	792877	sur demande	19	8165004	28,87/m	36
736620	54,16/m	33	784076	49,29/pc.	32	792880	sur demande	19	8166004	31,13/m	36
737198	10,02/pc.	25	784077	56,57/pc.	32	792881	sur demande	19	8167004	36,17/m	36
737704	27,96/pc.	25	784078	63,28/pc.	32	792882	sur demande	19	8168004	49,83/m	36
737705	27,96/pc.	25	784079	71,69/pc.	32	792883	sur demande	19	8180000	0,14/pc.	46
737706	27,96/pc.	25	784080	90,18/pc.	32	792884	sur demande	19	8190000	0,05/pc.	46
737707	27,96/pc.	25	784081	43,69/pc.	33	792885	sur demande	19	8190020	0,18/pc.	46
737708	27,96/pc.	25	784082	45,92/pc.	33	792888	sur demande	20	8250109	5,82/pc.	37
739713	118,79/pc.	25	784083	48,73/pc.	33	792893	sur demande	8	8250209	6,83/pc.	37
760200	7,74/m	36	784084	57,12/pc.	33	792903	sur demande	19	08461000	0,18/pc.	46
762400	1,94/pc.	36	784085	258,44/pc.	33	792904	sur demande	19	08461020	0,23/pc.	46
768001	54,78/m	6	784086	72,25/pc.	33	792905	sur demande	19	08462000	0,20/pc.	46
768002	54,78/m	6	784087	86,81/pc.	33	792906	sur demande	19	08462020	0,22/pc.	46
768004	56,88/m	6	784088	105,86/pc.	33	792907	sur demande	19	8601004	12,50/m	34
768005	59,51/m	6	784089	43,13/pc.	32	792908	sur demande	19	8601202	10,17/m	34
768006	63,87/m	6	784090	47,04/pc.	32	792920	sur demande	20	8601204	11,91/m	34
768007	66,64/m	6	784091	48,73/pc.	32	792921	sur demande	20	8601404	11,91/m	34
768063	40,21/m	11	784092	55,46/pc.	32	792922	sur demande	20	8602004	14,84/m	34
768733	13,04/pc.	17	784093	63,28/pc.	32	792923	sur demande	20	8602202	11,40/m	34
768738	17,84/pc.	8	784094	70,57/pc.	32	792924	sur demande	20	8602204	14,16/m	34
769000	4,53/pc.	24	784095	78,41/pc.	32	794202	28,33/pc.	114	8602404	14,16/m	34
769001	4,74/pc.	24	784096	91,85/pc.	32	794715	0,21/pc.	115	8603004	19,28/m	34
769002	4,87/pc.	24	784097	47,61/pc.	33	795051	13,33/pc.	14	8603202	15,25/m	34
769003	5,08/pc.	24	784098	50,97/pc.	33	795051	13,33/pc.	114	8603204	18,35/m	34
769004	5,48/pc.	24	784099	53,20/pc.	33	795132	0,72/pc.	115	8603404	18,35/m	34
769005	6,32/pc.	24	784100	59,94/pc.	33	795239	5,08/pc.	114	8604004	23,10/m	34
769006	6,53/pc.	24	784101	69,45/pc.	33	795240	3,80/pc.	7	8604202	17,15/m	34
769007	7,20/pc.	24	784102	74,49/pc.	33	795241	5,28/pc.	7	8604204	22,00/m	34
769008	7,80/pc.	24	784103	85,13/pc.	33	795242	6,02/pc.	7	8604404	22,00/m	34
769009	4,47/pc.	24	784104	108,09/pc.	33	795316	7,56/pc.	6	8605004	28,66/m	34
769010	4,53/pc.	24	786768	63,65/pc.	8	795316	7,56/pc.	44	8605204	27,30/m	34
769011	5,08/pc.	24	786768	63,65/pc.	114	795317	8,54/pc.	6	8605404	32,43/m	34
769012	5,13/pc.	24	787276	104,74/pc.	9	795317	8,54/pc.	44	8606204	33,08/m	34
769013	5,54/pc.	24	787276	104,74/pc.	44	795318	12,51/pc.	6	8607205	53,72/m	34
769014	5,93/pc.	24	787278	sur demande	9	795318	12,51/pc.	44	8608205	62,18/m	34
769015	7,80/pc.	24	788164	19,36/pc.	11	795319	14,20/pc.	6	8750000	11,14/set	35
769016	8,05/pc.	24	788165	27,78/pc.	11	795319	14,20/pc.	44	8856050	1,11/pc.	37
780186	409,80/pc.	25	788572	5,20/pc.	32	795320	19,34/pc.	6	08890000	0,18/pc.	46
780187	4577,17/set	25	788573	6,16/pc.	33	795320	19,34/pc.	44	08890100	0,53/pc.	46
780452	36,42/pc.	26	788638	104,82/pc.	18	795321	21,83/pc.	6	08891000	0,16/pc.	46
780453	38,12/pc.	26	788639	sur demande	27	795321	21,83/pc.	44	08900000	0,18/pc.	46
780454	41,55/pc.	26	788640	sur demande	27	795322	17,73/pc.	6	08901000	0,08/pc.	46
780455	43,33/pc.	26	788641	sur demande	27	795322	17,73/pc.	44	8940000	8,33/pc.	40
780456	46,79/pc.	26	788642	sur demande	27	795323	20,14/pc.	6	8960000	12,83/pc.	40
780457	48,52/pc.	26	788643	sur demande	27	795323	20,14/pc.	44	8980000	8,66/pc.	39
781099	69,67/m	5	788644	sur demande	27	8010109	1,51/pc.	35	30060702	9,62/pc.	38
781433	111,00/pc.	27	788647	sur demande	28	8040000	58,37/pc.	37	30061002	10,54/pc.	38
781434	139,29/pc.	27	788648	sur demande	28	08050000	4,57/m	46	30061202	11,53/pc.	38
781435	156,72/pc.	27	788649	sur demande	28	08050100	4,57/m	46	30061502	13,74/pc.	38
781436	194,89/pc.	27	788650	sur demande	28	08050200	2,54/m	46	30062002	14,34/pc.	38
781437	207,00/pc.	27	788651	sur demande	28	08051000	3,84/m	46	30062502	16,86/pc.	38
781438	235,77/pc.	27	788652	sur demande	28	08051020	15,10/m	46	30063002	23,42/pc.	38
781440	137,14/pc.	27	789875	2,65/pc.	16	8090109	6,30/pc.	37	30063302	24,14/pc.	38
781441	161,64/pc.	27	789876	6,86/pc.	16	8101009	4,10/pc.	43	30064002	31,36/pc.	38
781442	194,36/pc.	27	791063	19,22/pc.	8	8112009	4,96/pc.	43	30065002	43,78/pc.	38
781443	235,97/pc.	27	791064	19,64/pc.	8	8123009	7,06/pc.	43	30066002	63,51/pc.	38
781444	285,93/pc.	27	791065	20,07/pc.	8	8134009	7,98/pc.	43	30070702	7,49/pc.	39

# Index

référence	prix en €	page	référence	prix en €	page	référence	prix en €	page	référence	prix en €	page
30071002	7,98/pc.	39	36070702	16,76/pc.	39	36243002	92,10/pc.	41	60222300	21,11/m	116
30071202	9,47/pc.	39	36071002	17,84/pc.	39	36243302	103,09/pc.	41	60222400	30,33/m	78
30071502	10,93/pc.	39	36071202	18,24/pc.	39	36244002	112,85/pc.	41	60222400	30,33/m	116
30072002	12,28/pc.	39	36071502	18,65/pc.	39	36245002	152,92/pc.	41	60222500	37,46/m	78
30072502	14,60/pc.	39	36072002	20,21/pc.	39	36246002	187,34/pc.	41	60222600	44,40/m	78
30073002	15,82/pc.	39	36072502	23,07/pc.	39	36252202	20,61/pc.	40	60223100	20,70/m	79
30073302	18,62/pc.	39	36073002	33,00/pc.	39	36252402	27,10/pc.	40	60223150	25,40/m	79
30074002	21,55/pc.	39	36073302	39,27/pc.	39	36252602	28,04/pc.	40	60223200	27,85/m	79
30075002	24,50/pc.	39	36074002	45,56/pc.	39	36254702	28,76/pc.	40	60223300	33,33/m	79
30076002	30,21/pc.	39	36075002	59,44/pc.	39	36254802	37,82/pc.	40	60223400	43,56/m	79
30150702	12,90/pc.	38	36076002	59,74/pc.	39	36256402	41,31/pc.	40	60223500	52,30/m	79
30151002	13,75/pc.	38	36110002	7,25/pc.	39	36430702	37,20/pc.	41	60223600	53,45/m	79
30151202	15,09/pc.	38	36150702	31,67/pc.	38	36431002	37,93/pc.	41	60225020	15,85/m	92
30151502	15,46/pc.	38	36151002	34,31/pc.	38	36431202	38,42/pc.	41	60230000	15,59/m	93
30152002	17,36/pc.	38	36151202	36,23/pc.	38	36431502	46,99/pc.	41	60231060	10,59/m	77
30152502	19,50/pc.	38	36151502	38,15/pc.	38	36432002	47,98/pc.	41	60231100	11,72/m	77
30153002	22,45/pc.	38	36152002	41,72/pc.	38	36432502	51,68/pc.	41	60231150	15,15/m	77
30153302	24,63/pc.	38	36152502	49,48/pc.	38	36433002	52,07/pc.	41	60231200	17,21/m	77
30154002	29,69/pc.	38	36153002	57,24/pc.	38	36433302	52,58/pc.	41	60231300	23,83/m	77
30155002	57,98/pc.	38	36153302	63,98/pc.	38	36434002	57,37/pc.	41	60231400	28,34/m	77
30156002	70,80/pc.	38	36154002	79,78/pc.	38	36435002	62,78/pc.	41	60232060	12,00/m	78
30160702	21,53/pc.	39	36155002	90,07/pc.	38	36436002	65,48/pc.	41	60232100	16,23/m	78
30161002	23,33/pc.	39	36156002	109,61/pc.	38	36510702	14,31/pc.	40	60232100	16,23/m	116
30161202	24,50/pc.	39	36160702	49,67/pc.	39	36511002	15,00/pc.	40	60232150	20,09/m	78
30161502	25,46/pc.	39	36161002	50,56/pc.	39	36511202	15,44/pc.	40	60232150	20,09/m	116
30162002	27,96/pc.	39	36161202	51,14/pc.	39	36511502	16,02/pc.	40	60232200	23,78/m	78
30162502	31,01/pc.	39	36161502	51,98/pc.	39	36512002	17,14/pc.	40	60232200	23,78/m	116
30163002	34,89/pc.	39	36162002	53,91/pc.	39	36512502	19,65/pc.	40	60232300	32,52/m	78
30163302	37,81/pc.	39	36162502	63,10/pc.	39	36513002	21,26/pc.	40	60232300	32,52/m	116
30164002	44,69/pc.	39	36163002	69,56/pc.	39	36513302	22,99/pc.	40	60232400	42,95/m	78
30165002	53,66/pc.	39	36163302	91,36/pc.	39	36514002	27,90/pc.	40	60232400	42,95/m	116
30166002	64,38/pc.	39	36164002	103,89/pc.	39	36520702	24,23/pc.	38	60232500	50,66/m	78
30220702	9,62/pc.	41	36165002	122,46/pc.	39	36521002	26,76/pc.	38	60232600	59,58/m	78
30221002	10,32/pc.	41	36166002	150,08/pc.	39	36521202	27,40/pc.	38	60233100	25,59/m	79
30221202	11,18/pc.	41	36180704	5,60/pc.	41	36521502	28,33/pc.	38	60233150	28,45/m	79
30221502	12,52/pc.	41	36181004	5,89/pc.	41	36522002	29,63/pc.	38	60233200	37,17/m	79
30222002	14,34/pc.	41	36181204	6,29/pc.	41	36522502	33,27/pc.	38	60233300	47,31/m	79
30222502	18,12/pc.	41	36181504	6,75/pc.	41	36523002	34,98/pc.	38	60233400	57,72/m	79
30223002	20,33/pc.	41	36182004	7,03/pc.	41	36523302	52,08/pc.	38	60233500	67,35/m	79
30223302	22,45/pc.	41	36182504	7,57/pc.	41	36524002	91,94/pc.	38	60233600	71,90/m	79
30224002	28,33/pc.	41	36183004	8,60/pc.	41	36525002	129,64/pc.	38	60250000	29,89/m	93
30225002	33,85/pc.	41	36183304	9,22/pc.	41	36526002	151,59/pc.	38	60251060	29,98/m	77
30226002	43,49/pc.	41	36184004	9,99/pc.	41	60102011	196,84/set	91	60251100	35,72/m	77
30230702	9,62/pc.	40	36185004	11,90/pc.	41	60211060	8,83/m	77	60251150	42,52/m	77
30231002	10,11/pc.	40	36186004	13,87/pc.	41	60211100	9,11/m	77	60251200	55,04/m	77
30231202	11,18/pc.	40	36220702	18,40/pc.	41	60211150	12,80/m	77	60251300	72,77/m	77
30231502	13,02/pc.	40	36221002	20,21/pc.	41	60211200	13,99/m	77	60251400	109,09/m	77
30232002	14,34/pc.	40	36221202	22,21/pc.	41	60211300	20,09/m	77	60252060	36,06/m	78
30232502	18,12/pc.	40	36221502	24,18/pc.	41	60211400	25,18/m	77	60252100	49,11/m	78
30233002	21,53/pc.	40	36222002	26,62/pc.	41	60212060	8,34/m	78	60252150	58,18/m	78
30233302	22,45/pc.	40	36222502	33,65/pc.	41	60212100	10,68/m	78	60252200	66,99/m	78
30234002	28,33/pc.	40	36223002	42,45/pc.	41	60212150	13,20/m	78	60252300	84,67/m	78
30235002	33,85/pc.	40	36223302	46,73/pc.	41	60212200	14,97/m	78	60252400	105,86/m	78
30236002	43,49/pc.	40	36224002	56,60/pc.	41	60212300	19,42/m	78	60252500	125,24/m	78
30252202	9,14/pc.	40	36225002	68,40/pc.	41	60212400	27,90/m	78	60252600	142,32/m	78
30252402	10,44/pc.	40	36226002	74,10/pc.	41	60212500	34,47/m	78	60253100	61,67/m	79
30252602	13,11/pc.	40	36230702	18,40/pc.	40	60212600	40,84/m	78	60253150	69,49/m	79
30254702	11,82/pc.	40	36231002	20,21/pc.	40	60215020	15,85/m	92	60253200	87,94/m	79
30254802	15,40/pc.	40	36231202	22,21/pc.	40	60220000	12,59/m	93	60253300	106,00/m	79
30256402	15,72/pc.	40	36231502	24,18/pc.	40	60221060	8,83/m	77	60253400	124,45/m	79
33105001	82,37/pc.	225	36232002	26,62/pc.	40	60221100	9,11/m	77	60253500	144,46/m	79
33105002	143,76/pc.	225	36232502	33,65/pc.	40	60221150	12,80/m	77	60253600	161,82/m	79
36060702	23,55/pc.	38	36233002	42,45/pc.	40	60221200	13,99/m	77	60281060	9,32/m	77
36061002	24,78/pc.	38	36233302	46,73/pc.	40	60221300	20,09/m	77	60281100	10,32/m	77
36061202	25,32/pc.	38	36234002	56,60/pc.	40	60221400	25,18/m	77	60281150	13,33/m	77
36061502	26,15/pc.	38	36235002	68,40/pc.	40	60222060	8,87/m	78	60281200	15,15/m	77
36062002	28,09/pc.	38	36236002	74,10/pc.	40	60222100	11,61/m	78	60281300	20,97/m	77
36062502	34,35/pc.	38	36240702	61,30/pc.	41	60222100	11,61/m	116	60281400	24,94/m	77
36063002	41,55/pc.	38	36241002	61,61/pc.	41	60222150	14,35/m	78	60282060	10,57/m	78
36063302	45,19/pc.	38	36241202	64,19/pc.	41	60222150	14,35/m	116	60282100	14,31/m	78
36064002	53,69/pc.	38	36241502	66,67/pc.	41	60222200	16,28/m	78	60282150	17,68/m	78
36065002	67,84/pc.	38	36242002	69,90/pc.	41	60222200	16,28/m	116	60282200	20,94/m	78
36066002	86,47/pc.	38	36242502	80,48/pc.	41	60222300	21,11/m	78	60282300	28,61/m	78

# Index

référence	prix en €	page	référence	prix en €	page	référence	prix en €	page	référence	prix en €	page
60282400	37,79/m	78	62022404	22,73/pc.	94	62032404	34,65/pc.	94	62057002	sur demande	69
60282500	44,57/m	78	62022404	22,73/pc.	117	62032404	34,65/pc.	117	62057002	sur demande	95
60282600	52,60/m	78	62025103	7,37/pc.	69	62035001	5,83/pc.	118	62061060	7,06/pc.	89
60522060	11,82/m	79	62025103	7,37/pc.	95	62035001	5,83/pc.	121	62066010	11,65/pc.	87
60522100	15,24/m	79	62025103	7,37/pc.	118	62035103	11,39/pc.	69	62066011	24,42/pc.	87
60522150	18,68/m	79	62025103	7,37/pc.	121	62035103	11,39/pc.	95	62066022	14,83/pc.	89
60522200	20,24/m	79	62025153	8,60/pc.	69	62035103	11,39/pc.	118	62081060	3,94/pc.	89
60522300	25,62/m	79	62025153	8,60/pc.	95	62035103	11,39/pc.	121	62081104	9,03/pc.	94
60522400	37,04/m	79	62025153	8,60/pc.	118	62035153	12,73/pc.	69	62081154	11,55/pc.	94
60522500	45,00/m	79	62025153	8,60/pc.	121	62035153	12,73/pc.	95	62081204	12,38/pc.	94
60522600	53,27/m	79	62025203	9,89/pc.	69	62035153	12,73/pc.	118	62081304	13,24/pc.	94
60613206	14,85/m	92	62025203	9,89/pc.	95	62035153	12,73/pc.	121	62081404	20,44/pc.	94
60613306	17,40/m	92	62025203	9,89/pc.	118	62035203	15,04/pc.	69	62081504	23,71/pc.	97
60613310	21,69/m	92	62025203	9,89/pc.	121	62035203	15,04/pc.	95	62081604	28,38/pc.	97
60613315	23,59/m	92	62025303	11,33/pc.	69	62035203	15,04/pc.	118	62082104	15,41/pc.	94
60613320	28,03/m	92	62025303	11,33/pc.	95	62035203	15,04/pc.	121	62082154	16,94/pc.	94
60623206	15,29/m	92	62025303	11,33/pc.	118	62035303	18,62/pc.	69	62082204	18,91/pc.	94
60623306	17,91/m	92	62025303	11,33/pc.	121	62035303	18,62/pc.	95	62082304	22,66/pc.	94
60623310	22,35/m	92	62025403	16,36/pc.	69	62035303	18,62/pc.	118	62082404	34,65/pc.	94
60623315	24,32/m	92	62025403	16,36/pc.	95	62035303	18,62/pc.	121	62085103	11,39/pc.	95
60623320	28,83/m	92	62025403	16,36/pc.	118	62035403	20,82/pc.	69	62085153	12,73/pc.	95
60633206	21,91/m	92	62025403	16,36/pc.	121	62035403	20,82/pc.	95	62085203	15,04/pc.	95
60633306	26,72/m	92	62025503	18,99/pc.	69	62035403	20,82/pc.	118	62085303	18,62/pc.	95
60633310	31,52/m	92	62025503	18,99/pc.	95	62035403	20,82/pc.	121	62085403	20,82/pc.	95
60633315	33,63/m	92	62025603	21,60/pc.	69	62035503	25,97/pc.	69	62085503	25,97/pc.	95
60633320	41,35/m	92	62025603	21,60/pc.	95	62035503	25,97/pc.	95	62085603	30,21/pc.	95
60683206	19,29/m	92	62026010	3,07/pc.	87	62035603	30,21/pc.	69	62086010	6,58/pc.	87
60683306	23,51/m	92	62026011	5,71/pc.	87	62035603	30,21/pc.	95	62086011	10,04/pc.	87
60683310	27,74/m	92	62026020	6,85/pc.	88	62036010	6,58/pc.	87	62086020	10,20/pc.	88
60683315	29,56/m	92	62026021	1,71/pc.	88	62036011	10,04/pc.	87	62086021	2,85/pc.	88
60683320	36,40/m	92	62026022	5,65/pc.	89	62036020	10,20/pc.	88	62086022	7,52/pc.	89
62011060	2,93/pc.	89	62031060	3,94/pc.	89	62036021	2,85/pc.	88	62301100	5,74/pc.	103
62016020	6,85/pc.	88	62031084	0,93/pc.	96	62036022	7,52/pc.	89	62301400	6,51/pc.	103
62016021	1,71/pc.	88	62031085	0,46/pc.	96	62037002	18,32/pc.	69	62301800	11,83/pc.	103
62016022	5,65/pc.	89	62031090	5,83/pc.	117	62037002	18,32/pc.	95	62302102	0,63/m	103
62021060	2,93/pc.	89	62031090	5,83/pc.	120	62051104	18,67/pc.	70	62302401	0,70/m	103
62021104	5,90/pc.	70	62031104	9,03/pc.	70	62051104	18,67/pc.	94	62302801	1,05/m	103
62021104	5,90/pc.	94	62031104	9,03/pc.	94	62051154	23,16/pc.	70	62303101	9,17/pc.	103
62021104	5,90/pc.	117	62031104	9,03/pc.	117	62051154	23,16/pc.	94	62303103	11,69/pc.	103
62021104	5,90/pc.	120	62031104	9,03/pc.	120	62051204	29,13/pc.	70	62303105	14,21/pc.	103
62021154	7,63/pc.	70	62031154	11,55/pc.	70	62051204	29,13/pc.	94	62303301	11,13/pc.	103
62021154	7,63/pc.	94	62031154	11,55/pc.	94	62051304	35,31/pc.	70	62303303	14,07/pc.	103
62021154	7,63/pc.	117	62031154	11,55/pc.	117	62051304	35,31/pc.	94	62303305	16,94/pc.	103
62021154	7,63/pc.	120	62031154	11,55/pc.	120	62051404	42,95/pc.	70	62303601	26,11/pc.	103
62021204	8,74/pc.	70	62031204	12,38/pc.	70	62051404	42,95/pc.	94	62303603	29,40/pc.	103
62021204	8,74/pc.	94	62031204	12,38/pc.	94	62051504	49,63/pc.	70	62303605	32,69/pc.	103
62021204	8,74/pc.	117	62031204	12,38/pc.	117	62051504	49,63/pc.	97	62304101	9,38/pc.	103
62021204	8,74/pc.	120	62031204	12,38/pc.	120	62051604	56,48/pc.	70	62304103	11,90/pc.	103
62021304	10,30/pc.	70	62031304	13,24/pc.	70	62051604	56,48/pc.	97	62304105	19,81/pc.	103
62021304	10,30/pc.	94	62031304	13,24/pc.	94	62052104	31,86/pc.	70	62304301	11,41/pc.	103
62021304	10,30/pc.	117	62031304	13,24/pc.	117	62052104	31,86/pc.	94	62304303	14,35/pc.	103
62021304	10,30/pc.	120	62031304	13,24/pc.	120	62052154	34,56/pc.	70	62304305	17,29/pc.	103
62021404	15,41/pc.	70	62031404	20,44/pc.	70	62052154	34,56/pc.	94	62304601	12,88/pc.	103
62021404	15,41/pc.	94	62031404	20,44/pc.	94	62052204	45,43/pc.	70	62304603	16,24/pc.	103
62021404	15,41/pc.	117	62031404	20,44/pc.	117	62052204	45,43/pc.	94	62304605	28,14/pc.	103
62021404	15,41/pc.	120	62031404	20,44/pc.	120	62052304	52,20/pc.	70	62305430	8,82/pc.	103
62021504	17,61/pc.	70	62031504	23,71/pc.	70	62052304	52,20/pc.	94	62305440	9,10/pc.	103
62021504	17,61/pc.	97	62031504	23,71/pc.	97	62052404	60,33/pc.	70	62306230	7,98/pc.	104
62021604	21,00/pc.	70	62031604	28,38/pc.	70	62052404	60,33/pc.	94	62306240	8,26/pc.	104
62021604	21,00/pc.	97	62031604	28,38/pc.	97	62055103	25,63/pc.	69	62306250	8,47/pc.	104
62022104	11,65/pc.	70	62032104	15,41/pc.	70	62055103	25,63/pc.	95	62307231	19,18/pc.	103
62022104	11,65/pc.	94	62032104	15,41/pc.	94	62055153	28,25/pc.	69	62307233	20,79/pc.	103
62022104	11,65/pc.	117	62032104	15,41/pc.	117	62055153	28,25/pc.	95	62307241	19,25/pc.	103
62022154	12,24/pc.	70	62032154	16,94/pc.	70	62055203	31,60/pc.	69	62307243	20,86/pc.	103
62022154	12,24/pc.	94	62032154	16,94/pc.	94	62055203	31,60/pc.	95	62307631	25,55/pc.	103
62022154	12,24/pc.	117	62032154	16,94/pc.	117	62055303	38,37/pc.	69	62307633	29,89/pc.	103
62022204	13,16/pc.	70	62032204	18,91/pc.	70	62055303	38,37/pc.	95	62307641	25,55/pc.	103
62022204	13,16/pc.	94	62032204	18,91/pc.	94	62055403	64,28/pc.	69	62307643	28,77/pc.	103
62022204	13,16/pc.	117	62032204	18,91/pc.	117	62055403	64,28/pc.	95	62308231	17,36/pc.	104
62022304	15,41/pc.	70	62032304	22,66/pc.	70	62055503	72,54/pc.	69	62308233	18,76/pc.	104
62022304	15,41/pc.	94	62032304	22,66/pc.	94	62055503	72,54/pc.	95	62308241	17,29/pc.	104
62022304	15,41/pc.	117	62032304	22,66/pc.	117	62055603	82,41/pc.	69	62308243	18,90/pc.	104
62022404	22,73/pc.	70	62032404	34,65/pc.	70	62055603	82,41/pc.	95	62308631	24,78/pc.	104

# Index

référence	prix en €	page	référence	prix en €	page	référence	prix en €	page	référence	prix en €	page
62308633	27,16/pc.	104	64020062	0,58/pc.	83	67020052	1,86/pc.	93	67030063	0,11/pc.	99
62308641	24,99/pc.	104	64020072	1,32/pc.	82	67020053	4,22/pc.	82	67030064	30,43/pc.	110
62308643	27,37/pc.	104	64030030	4,62/pc.	81	67020054	0,23/pc.	99	67030065	0,57/pc.	99
62309501	92,40/pc.	104	64030035	3,05/pc.	80	67020055	0,62/pc.	111	67030066	0,80/pc.	99
62309502	107,03/pc.	104	64030036	4,34/pc.	80	67020058	1,66/pc.	111	67030066	0,80/pc.	111
62309503	121,73/pc.	104	64030041	2,18/pc.	81	67020059	0,77/pc.	99	67030068	0,61/pc.	99
62310201	18,76/pc.	104	64030059	0,23/pc.	58	67020061	0,18/pc.	72	67030077	1,52/pc.	99
63022104	4,00/pc.	71	64030059	0,23/pc.	98	67020061	0,18/pc.	99	67030077	1,52/pc.	111
63022104	4,00/pc.	96	64030059	0,23/pc.	120	67020062	0,15/pc.	99	67030077	1,52/pc.	118
63022104	4,00/pc.	120	64030060	1,61/pc.	83	67020062	0,15/pc.	117	67030093	0,46/pc.	58
63022154	4,41/pc.	71	64030060	1,61/pc.	116	67020062	0,15/pc.	119	67030093	0,46/pc.	98
63022154	4,41/pc.	96	64030061	2,06/pc.	80	67020063	0,11/pc.	99	67030093	0,46/pc.	119
63022154	4,41/pc.	120	64030061	2,06/pc.	116	67020077	1,00/pc.	99	67030099	0,28/pc.	58
63022204	5,53/pc.	71	64030062	0,61/pc.	83	67020077	1,00/pc.	111	67030099	0,28/pc.	98
63022204	5,53/pc.	96	64030072	1,82/pc.	82	67020077	1,00/pc.	118	67030100	0,41/pc.	58
63022204	5,53/pc.	120	64030160	1,97/pc.	117	67020079	0,17/pc.	72	67030100	0,41/pc.	98
63022304	6,51/pc.	71	64060041	7,49/pc.	81	67020079	0,17/pc.	99	67030101	13,76/pc.	110
63022304	6,51/pc.	96	64060059	0,94/pc.	65	67020083	0,08/pc.	72	67030102	26,06/pc.	110
63022304	6,51/pc.	120	64060059	0,94/pc.	98	67020083	0,08/pc.	99	67030109	0,41/pc.	98
63022404	8,80/pc.	71	64060060	4,10/pc.	83	67020084	0,24/pc.	72	67030109	0,41/pc.	120
63022404	8,80/pc.	96	64060061	5,98/pc.	80	67020084	0,24/pc.	100	67030110	43,28/m	71
63022404	8,80/pc.	120	64060062	2,15/pc.	83	67020086	0,33/pc.	72	67030110	43,28/m	96
63022504	9,91/pc.	71	64080030	4,62/pc.	81	67020086	0,33/pc.	100	67030111	43,28/m	71
63022504	9,91/pc.	96	64080035	3,05/pc.	80	67020092	0,77/pc.	99	67030111	43,28/m	96
63022604	13,11/pc.	71	64080036	4,34/pc.	80	67020095	0,15/pc.	72	67030112	43,28/m	71
63022604	13,11/pc.	96	64080041	2,18/pc.	81	67020095	0,15/pc.	99	67030112	43,28/m	96
63032104	6,64/pc.	71	64080060	1,61/pc.	83	67020098	1,68/pc.	93	67030120	8,23/pc.	97
63032104	6,64/pc.	96	64080061	2,06/pc.	80	67020100	0,24/pc.	98	67030143	4,54/pc.	90
63032104	6,64/pc.	120	64080072	1,82/pc.	82	67020110	26,55/m	71	67030158	1,92/pc.	111
63032154	7,10/pc.	71	67010016	7,30/pc.	87	67020110	26,55/m	96	67030158	1,92/pc.	118
63032154	7,10/pc.	96	67010030	8,07/pc.	86	67020111	26,55/m	71	67030164	28,10/pc.	110
63032154	7,10/pc.	120	67010040	4,52/pc.	88	67020111	26,55/m	96	67030201	2,33/pc.	108
63032204	8,69/pc.	71	67010043	3,64/pc.	90	67020112	26,55/m	71	67030202	4,66/pc.	108
63032204	8,69/pc.	96	67010046	1,23/pc.	90	67020112	26,55/m	96	67030203	13,32/pc.	109
63032204	8,69/pc.	120	67010052	1,86/pc.	93	67020120	5,16/pc.	97	67030204	10,19/pc.	109
63032304	10,42/pc.	71	67010053	4,22/pc.	82	67020140	4,45/pc.	100	67030205	5,10/pc.	108
63032304	10,42/pc.	96	67010056	0,94/pc.	111	67020141	5,46/m	100	67030206	6,84/pc.	109
63032304	10,42/pc.	120	67010065	0,46/pc.	99	67020143	3,64/pc.	90	67030207	14,34/pc.	109
63032404	12,65/pc.	71	67010066	0,62/pc.	99	67020145	6,96/m	100	67030208	6,19/pc.	109
63032404	12,65/pc.	96	67010066	0,62/pc.	111	67020145	6,96/m	117	67030209	4,00/pc.	108
63032404	12,65/pc.	120	67010068	0,40/pc.	99	67020145	6,96/m	119	67030210	4,00/pc.	108
63032504	14,94/pc.	71	67010093	0,33/pc.	50	67020158	1,87/pc.	111	67030211	5,39/pc.	108
63032504	14,94/pc.	96	67010093	0,33/pc.	98	67020158	1,87/pc.	118	67030212	6,48/pc.	109
63032604	17,88/pc.	71	67010093	0,33/pc.	119	67020159	2,87/pc.	111	67030213	14,34/pc.	109
63032604	17,88/pc.	96	67010099	0,24/pc.	50	67020520	7,35/pc.	69	67030214	16,60/pc.	108
63032604	17,88/pc.	120	67010099	0,24/pc.	98	67020520	7,35/pc.	91	67030215	5,61/pc.	110
63082104	8,47/pc.	96	67010100	0,24/pc.	50	67020522	8,78/pc.	69	67030216	11,87/pc.	110
63082154	8,58/pc.	96	67010100	0,24/pc.	98	67020522	8,78/pc.	91	67030252	2,55/pc.	93
63082204	8,69/pc.	96	67010100	0,24/pc.	98	67020522	10,10/pc.	69	67030520	9,11/pc.	91
63082304	10,42/pc.	96	67010140	2,75/pc.	72	67020524	10,10/pc.	91	67030522	11,58/pc.	69
63082404	12,65/pc.	96	67010141	3,52/m	72	67020524	10,10/pc.	91	67030522	11,58/pc.	91
63082504	14,94/pc.	96	67010143	3,64/pc.	90	67020610	6,61/m	52	67030524	13,94/pc.	69
63082604	17,88/pc.	96	67010144	1,42/pc.	90	67020610	6,61/m	84	67030524	13,94/pc.	91
64010020	3,87/pc.	81	67011058	1,35/pc.	111	67020611	7,43/m	52	67030539	7,58/pc.	91
64010035	2,17/pc.	80	67020010	1,56/pc.	99	67020611	7,43/m	85	67030540	9,52/pc.	91
64010036	3,11/pc.	80	67020013	0,18/pc.	99	67020612	13,07/m	52	67030541	13,44/pc.	91
64010041	1,38/pc.	81	67020014	0,27/pc.	99	67020612	13,07/m	85	67030542	15,45/pc.	91
64010059	0,18/pc.	50	67020014	0,27/pc.	117	67030010	2,34/pc.	99	67030610	9,07/m	60
64010059	0,18/pc.	98	67020014	0,27/pc.	119	67030014	0,72/pc.	99	67030610	9,07/m	84
64010060	1,07/pc.	83	67020020	4,77/pc.	97	67030016	12,18/pc.	87	67030611	12,32/m	60
64010061	1,46/pc.	80	67020030	8,07/pc.	86	67030020	7,69/pc.	97	67030611	12,32/m	85
64010062	0,58/pc.	83	67020039	3,96/pc.	87	67030030	8,87/pc.	86	67030612	17,35/m	60
64010072	1,32/pc.	82	67020040	4,52/pc.	88	67030043	4,54/pc.	90	67030612	17,35/m	85
64020030	3,87/pc.	81	67020041	12,70/pc.	93	67030046	2,10/pc.	90	67030660	40,05/pc.	118
64020035	2,17/pc.	80	67020043	3,64/pc.	90	67030047	6,78/pc.	82	67030660	40,05/pc.	121
64020036	3,11/pc.	80	67020044	4,90/pc.	100	67030049	2,39/pc.	89	67030661	60,42/pc.	118
64020038	2,72/pc.	79	67020044	4,90/pc.	117	67030049	2,39/pc.	110	67030661	60,42/pc.	121
64020040	2,72/pc.	79	67020044	4,90/pc.	119	67030056	1,25/pc.	111	67030662	77,02/pc.	118
64020041	1,38/pc.	81	67020045	5,63/m	100	67030058	1,82/pc.	111	67030662	77,02/pc.	121
64020059	0,18/pc.	98	67020045	5,63/m	117	67030059	1,03/pc.	99	67030663	135,00/pc.	118
64020060	1,07/pc.	83	67020046	5,63/m	119	67030060	3,35/pc.	97	67030663	135,00/pc.	121
64020060	1,07/pc.	116	67020046	1,23/pc.	90	67030061	7,98/pc.	97	67031054	1,04/pc.	111
64020061	1,46/pc.	80	67020048	34,47/pc.	97	67030062	0,21/pc.	99			
64020061	1,46/pc.	116	67020051	9,16/pc.	93						



# Index

référence	prix en €	page	référence	prix en €	page	référence	prix en €	page	référence	prix en €	page
67031058	1,56/pc.	111	68000066	279,91/pc.	91	70024240	57,97/pc.	55	70031100	18,49/pc.	64
67050520	11,35/pc.	69	70020110	23,96/pc.	53	70024250	108,30/pc.	55	70031200	19,79/pc.	64
67050520	11,35/pc.	91	70020115	26,76/pc.	53	70024260	149,25/pc.	55	70031300	sur demande	64
67050522	18,74/pc.	69	70020120	30,64/pc.	53	70024320	sur demande	55	70031400	sur demande	64
67050522	18,74/pc.	91	70020130	35,55/pc.	53	70024330	sur demande	55	70032110	38,28/pc.	62
67050524	25,79/pc.	69	70020206	22,87/pc.	53	70024340	sur demande	55	70032115	42,73/pc.	62
67050524	25,79/pc.	91	70020210	22,87/pc.	53	70024350	sur demande	55	70032120	50,10/pc.	62
67060010	4,12/pc.	99	70020215	24,54/pc.	53	70024360	sur demande	55	70032130	56,14/pc.	62
67060014	2,32/pc.	72	70020220	26,34/pc.	53	70025110	29,44/pc.	55	70032210	40,79/pc.	62
67060014	2,32/pc.	99	70020230	38,98/pc.	53	70025115	32,86/pc.	55	70032215	44,68/pc.	62
67060043	8,50/pc.	90	70020240	50,36/pc.	53	70025120	37,66/pc.	55	70032220	51,06/pc.	62
67060044	26,59/pc.	72	70020250	58,05/pc.	53	70025130	43,65/pc.	55	70032230	65,89/pc.	62
67060044	26,59/pc.	100	70020260	76,06/pc.	53	70025206	22,21/pc.	55	70032240	112,34/pc.	62
67060045	34,72/m	72	70020320	sur demande	53	70025210	22,21/pc.	55	70032250	155,94/pc.	62
67060045	34,72/m	100	70020330	sur demande	53	70025215	26,57/pc.	55	70032260	187,48/pc.	62
67060046	3,21/pc.	90	70020340	sur demande	53	70025220	29,24/pc.	55	70032320	sur demande	62
67060053	12,49/pc.	82	70020350	sur demande	53	70025230	44,02/pc.	55	70032330	sur demande	62
67060056	6,97/pc.	111	70020360	sur demande	53	70025240	58,27/pc.	55	70032340	sur demande	62
67060058	7,70/pc.	111	70020420	sur demande	53	70025250	64,17/pc.	55	70032350	sur demande	62
67060059	2,17/pc.	99	70020430	sur demande	53	70025260	84,13/pc.	55	70032360	sur demande	62
67060062	1,01/pc.	72	70020440	sur demande	53	70025320	sur demande	55	70033110	29,44/pc.	62
67060062	1,01/pc.	99	70020450	sur demande	53	70025330	sur demande	55	70033115	32,86/pc.	62
67060063	0,51/pc.	72	70020460	sur demande	53	70025340	sur demande	55	70033120	38,56/pc.	62
67060063	0,51/pc.	99	70021100	12,95/pc.	56	70025350	sur demande	55	70033130	44,68/pc.	62
67060064	0,75/pc.	72	70021200	13,52/pc.	56	70025360	sur demande	55	70033210	31,38/pc.	62
67060064	0,75/pc.	99	70021300	sur demande	56	70026110	29,44/pc.	56	70033215	35,14/pc.	62
67060065	0,98/pc.	99	70021400	sur demande	56	70026115	32,86/pc.	56	70033220	40,16/pc.	62
67060066	1,72/pc.	99	70022110	31,72/pc.	54	70026120	37,66/pc.	56	70033230	46,39/pc.	62
67060066	1,72/pc.	111	70022115	35,43/pc.	54	70026130	43,65/pc.	56	70033240	54,60/pc.	62
67060077	2,75/pc.	99	70022120	40,62/pc.	54	70026206	22,21/pc.	56	70033250	59,68/pc.	62
67060077	2,75/pc.	111	70022130	47,07/pc.	54	70026210	22,21/pc.	56	70033260	65,16/pc.	62
67060100	1,59/pc.	65	70022210	33,04/pc.	54	70026215	26,57/pc.	56	70033320	sur demande	62
67060100	1,59/pc.	98	70022215	37,03/pc.	54	70026220	29,24/pc.	56	70033330	sur demande	62
67060141	31,98/m	100	70022220	42,33/pc.	54	70026230	44,02/pc.	56	70033340	sur demande	62
67060143	8,50/pc.	90	70022230	48,89/pc.	54	70026240	58,27/pc.	56	70033350	sur demande	62
67060145	43,56/m	72	70022240	91,05/pc.	54	70026250	64,17/pc.	56	70033360	sur demande	62
67060145	43,56/m	100	70022250	130,71/pc.	54	70026260	84,13/pc.	56	70033420	sur demande	62
67060541	37,63/pc.	91	70022260	149,38/pc.	54	70026320	sur demande	56	70033430	sur demande	62
67060542	51,51/pc.	91	70022320	sur demande	54	70026330	sur demande	56	70033440	sur demande	62
67060610	30,35/m	84	70022330	sur demande	54	70026340	sur demande	56	70033450	sur demande	62
67060611	40,88/m	66	70022340	sur demande	54	70026350	sur demande	56	70033460	sur demande	62
67060611	40,88/m	85	70022350	sur demande	54	70026360	sur demande	56	70034110	42,80/pc.	63
67060612	53,50/m	85	70022360	sur demande	54	70027100	13,87/pc.	54	70034115	47,25/pc.	63
67061054	6,55/pc.	111	70023110	23,78/pc.	54	70027150	15,75/pc.	54	70034120	54,71/pc.	63
67080030	8,87/pc.	86	70023115	26,48/pc.	54	70028110	34,00/pc.	53	70034130	63,44/pc.	63
67080040	6,44/pc.	88	70023120	30,87/pc.	54	70028115	35,84/pc.	53	70034210	44,55/pc.	63
67080043	4,54/pc.	90	70023130	35,19/pc.	54	70028120	41,76/pc.	53	70034215	49,35/pc.	63
67080046	2,10/pc.	90	70023206	19,61/pc.	54	70028130	46,84/pc.	53	70034220	57,00/pc.	63
67080053	6,78/pc.	82	70023210	19,61/pc.	54	70028210	34,52/pc.	53	70034230	76,92/pc.	63
67080143	4,54/pc.	90	70023215	20,49/pc.	54	70028215	36,63/pc.	53	70034240	122,67/pc.	63
67080252	2,55/pc.	93	70023220	22,21/pc.	54	70028220	42,45/pc.	53	70034250	176,24/pc.	63
67620058	1,35/pc.	111	70023230	34,46/pc.	54	70028230	47,87/pc.	53	70034260	202,03/pc.	63
67620158	1,51/pc.	111	70023240	49,60/pc.	54	70030110	27,50/pc.	61	70034320	sur demande	63
67630058	1,46/pc.	111	70023250	56,79/pc.	54	70030115	30,64/pc.	61	70034330	sur demande	63
67630158	1,56/pc.	111	70023260	60,00/pc.	54	70030120	35,19/pc.	61	70034340	sur demande	63
67820058	1,46/pc.	111	70023320	sur demande	54	70030130	46,61/pc.	61	70034350	sur demande	63
67820158	1,61/pc.	111	70023330	sur demande	54	70030210	29,56/pc.	61	70034360	sur demande	63
67830058	1,66/pc.	111	70023340	sur demande	54	70030215	32,06/pc.	61	70035110	36,34/pc.	63
67830158	1,72/pc.	111	70023350	sur demande	54	70030220	36,69/pc.	61	70035115	40,56/pc.	63
68000010	1,90/pc.	86	70023360	sur demande	54	70030230	49,87/pc.	61	70035120	46,50/pc.	63
68000020	1,10/pc.	52	70023420	sur demande	54	70030240	85,47/pc.	61	70035130	53,91/pc.	63
68000020	1,10/pc.	60	70023430	sur demande	54	70030250	130,71/pc.	61	70035210	38,23/pc.	63
68000020	1,10/pc.	85	70023440	sur demande	54	70030260	157,76/pc.	61	70035215	42,85/pc.	63
68000032	8,87/pc.	82	70023450	sur demande	54	70030320	sur demande	61	70035220	48,95/pc.	63
68000034	5,58/pc.	52	70023460	sur demande	54	70030330	sur demande	61	70035230	67,61/pc.	63
68000034	5,58/pc.	60	70024110	34,69/pc.	55	70030340	sur demande	61	70035240	88,85/pc.	63
68000034	5,58/pc.	82	70024115	37,43/pc.	55	70030350	sur demande	61	70035250	103,84/pc.	63
68000040	1,33/pc.	86	70024120	43,36/pc.	55	70030360	sur demande	61	70035260	113,25/pc.	63
68000049	0,42/pc.	85	70024130	51,41/pc.	55	70030420	sur demande	61	70035320	sur demande	63
68000052	53,46/pc.	85	70024210	35,60/pc.	55	70030430	sur demande	61	70035330	sur demande	63
68000053	91,93/pc.	85	70024215	36,06/pc.	55	70030440	sur demande	61	70035340	sur demande	63
68000058	262,78/pc.	85	70024220	41,76/pc.	55	70030450	sur demande	61	70035350	sur demande	63
68000060	2,79/pc.	91	70024230	50,95/pc.	55	70030460	sur demande	61	70035360	sur demande	63

# Index

référence	prix en €	page	référence	prix en €	page	référence	prix en €	page	référence	prix en €	page
70036110	36,91/pc.	64	70056230	77,31/pc.	68	73021150	11,11/m	84	73032150	52,31/pc.	62
70036115	41,26/pc.	64	70056240	100,98/pc.	68	73021200	13,52/m	52	73032200	58,87/pc.	62
70036120	47,25/pc.	64	70056250	111,11/pc.	68	73021200	13,52/m	84	73032300	80,05/pc.	62
70036130	54,78/pc.	64	70056260	121,38/pc.	68	73021300	20,63/m	52	73032400	125,86/pc.	62
70036210	38,46/pc.	64	70058210	35,80/pc.	66	73021300	20,63/m	84	73032500	180,97/pc.	62
70036215	43,08/pc.	64	70058215	56,77/pc.	66	73021400	26,43/m	52	73032600	185,19/pc.	62
70036220	49,24/pc.	64	70058220	62,62/pc.	66	73021400	26,43/m	84	73033100	23,57/pc.	63
70036230	60,49/pc.	64	70058230	105,20/pc.	66	73021500	35,79/m	52	73033150	24,93/pc.	63
70036240	78,77/pc.	64	70120200	20,08/set	49	73021500	35,79/m	84	73033200	26,25/pc.	63
70036250	88,86/pc.	64	70122210	6,70/pc.	71	73021600	42,01/m	52	73033300	33,55/pc.	63
70036260	92,31/pc.	64	70122215	8,12/pc.	71	73021600	42,01/m	84	73033400	35,27/pc.	63
70036320	sur demande	64	70122220	9,43/pc.	71	73022100	26,48/pc.	54	73033500	42,68/pc.	63
70036330	sur demande	64	70122230	12,18/pc.	71	73022150	29,61/pc.	54	73033600	44,73/pc.	63
70036340	sur demande	64	70122240	14,81/pc.	71	73022200	33,84/pc.	54	73034100	36,29/pc.	63
70036350	sur demande	64	70130200	24,14/set	57	73022300	48,55/pc.	54	73034150	40,62/pc.	63
70036360	sur demande	64	70132210	9,33/pc.	71	73022400	72,00/pc.	54	73034200	45,35/pc.	63
70037100	35,09/pc.	61	70132215	11,30/pc.	71	73022500	103,45/pc.	54	73034300	74,28/pc.	63
70037150	39,54/pc.	61	70132220	13,38/pc.	71	73022600	118,15/pc.	54	73034400	99,85/pc.	63
70038110	38,23/pc.	61	70132230	17,34/pc.	71	73023060	20,20/pc.	55	73034500	143,44/pc.	63
70038115	40,90/pc.	61	70132240	21,17/pc.	71	73023100	20,20/pc.	55	73034600	163,85/pc.	63
70038120	48,67/pc.	61	70420911	5,76/pc.	52	73023150	20,49/pc.	55	73035100	30,24/pc.	63
70038130	56,77/pc.	61	70430911	8,74/pc.	60	73023200	21,51/pc.	55	73035150	33,89/pc.	63
70038210	39,36/pc.	61	71000000	6,56/m	52	73023300	27,78/pc.	55	73035200	38,74/pc.	63
70038215	42,62/pc.	61	71000000	6,56/m	60	73023400	28,98/pc.	55	73035300	63,50/pc.	63
70038220	50,49/pc.	61	71020300	7,71/pc.	51	73023500	35,27/pc.	55	73035400	83,30/pc.	63
70038230	59,51/pc.	61	71020400	8,95/pc.	51	73023600	36,51/pc.	55	73035500	119,64/pc.	63
70039110	22,42/pc.	61	71020500	10,04/pc.	51	73024100	29,95/pc.	55	73035600	119,64/pc.	63
70039115	29,28/pc.	61	71020600	12,10/pc.	51	73024150	32,70/pc.	55	73036100	29,05/pc.	64
70039120	34,17/pc.	61	71021005	1,37/pc.	51	73024200	36,97/pc.	55	73036150	32,52/pc.	64
70039130	45,53/pc.	61	71021006	1,14/pc.	51	73024300	51,58/pc.	55	73036200	37,14/pc.	64
70039210	24,19/pc.	61	71021010	21,57/pc.	53	73024400	79,54/pc.	55	73036300	51,98/pc.	64
70039215	30,92/pc.	61	71021015	27,85/pc.	53	73024500	112,96/pc.	55	73036400	79,93/pc.	64
70039220	37,43/pc.	61	71021020	29,61/pc.	53	73024600	129,12/pc.	55	73036500	114,86/pc.	64
70039230	51,69/pc.	61	71021030	39,99/pc.	53	73025060	24,53/pc.	56	73036600	131,23/pc.	64
70050210	46,29/pc.	67	71022010	22,93/pc.	53	73025100	24,53/pc.	56	73050100	49,92/pc.	67
70050215	52,21/pc.	67	71022015	30,00/pc.	53	73025150	27,45/pc.	56	73050150	59,42/pc.	67
70050220	81,10/pc.	67	71022020	33,84/pc.	53	73025200	31,38/pc.	56	73050200	82,87/pc.	67
70050230	105,98/pc.	67	71022030	44,16/pc.	53	73025300	43,88/pc.	56	73050300	89,65/pc.	67
70050240	149,14/pc.	67	71030300	10,84/pc.	59	73025400	67,50/pc.	56	73050400	162,25/pc.	67
70050250	217,03/pc.	67	71030400	12,55/pc.	59	73025500	96,94/pc.	56	73050500	203,96/pc.	67
70050260	219,66/pc.	67	71030500	17,12/pc.	59	73025600	110,74/pc.	56	73050600	209,61/pc.	67
70051200	19,48/pc.	68	71030600	20,54/pc.	59	73026060	23,73/pc.	56	73051060	27,96/m	84
70052210	56,85/pc.	67	71031005	1,82/pc.	59	73026100	23,73/pc.	56	73051100	39,51/m	66
70052215	62,12/pc.	67	71031006	1,60/pc.	59	73026150	26,58/pc.	56	73051100	39,51/m	84
70052220	80,02/pc.	67	71031010	22,82/pc.	61	73026200	30,35/pc.	56	73051150	52,71/m	66
70052230	105,98/pc.	67	71031015	29,72/pc.	61	73026300	42,50/pc.	56	73051150	52,71/m	84
70052240	214,67/pc.	67	71031020	34,69/pc.	61	73026400	65,38/pc.	56	73051200	64,55/m	66
70052250	216,66/pc.	67	71031030	46,22/pc.	61	73026500	93,85/pc.	56	73051200	64,55/m	84
70052260	218,31/pc.	67	71032010	24,53/pc.	61	73026600	107,27/pc.	56	73051300	90,22/m	66
70053210	41,79/pc.	67	71032015	31,38/pc.	61	73030100	24,01/pc.	62	73051300	90,22/m	84
70053215	42,02/pc.	67	71032020	37,99/pc.	61	73030150	26,93/pc.	62	73051400	116,47/m	66
70053220	53,57/pc.	67	71032030	49,52/pc.	61	73030200	30,07/pc.	62	73051400	116,47/m	84
70053230	53,91/pc.	67	71050300	16,07/pc.	66	73030300	42,96/pc.	62	73051500	126,73/m	66
70053240	74,88/pc.	67	71050400	21,92/pc.	66	73030400	72,12/pc.	62	73051500	126,73/m	84
70053250	74,96/pc.	67	71050500	27,10/pc.	66	73030500	92,82/pc.	62	73051600	173,80/m	66
70053260	75,45/pc.	67	71050600	31,63/pc.	66	73030600	108,46/pc.	62	73051600	173,80/m	84
70054210	62,33/pc.	68	71052010	42,22/pc.	66	73031060	11,13/m	60	73052100	67,68/pc.	67
70054215	90,79/pc.	68	71052015	55,00/pc.	66	73031060	11,13/m	84	73052150	84,09/pc.	67
70054220	82,73/pc.	68	71052020	72,87/pc.	66	73031100	15,52/m	60	73052200	106,40/pc.	67
70054230	148,05/pc.	68	71052030	93,92/pc.	66	73031100	15,52/m	84	73052300	139,01/pc.	67
70054240	214,39/pc.	68	73020060	19,97/pc.	53	73031150	21,11/m	60	73052400	268,52/pc.	67
70054250	217,03/pc.	68	73020100	19,97/pc.	53	73031150	21,11/m	84	73052500	292,05/pc.	67
70054260	291,20/pc.	68	73020150	22,82/pc.	53	73031200	26,71/m	60	73052600	286,34/pc.	67
70055210	55,06/pc.	68	73020200	25,56/pc.	53	73031200	26,71/m	84	73053100	45,50/pc.	67
70055215	64,83/pc.	68	73020300	34,00/pc.	53	73031300	40,62/m	60	73053150	46,92/pc.	67
70055220	65,83/pc.	68	73020400	62,70/pc.	53	73031300	40,62/m	84	73053200	47,72/pc.	67
70055230	80,59/pc.	68	73020500	78,97/pc.	53	73031400	52,60/m	60	73053300	62,26/pc.	67
70055240	102,85/pc.	68	73020600	90,20/pc.	53	73031400	52,60/m	84	73053400	60,12/pc.	67
70055250	148,99/pc.	68	73021060	6,64/m	52	73031500	64,58/m	60	73053500	84,16/pc.	67
70055260	148,99/pc.	68	73021060	6,64/m	84	73031500	64,58/m	84	73053600	87,15/pc.	67
70056210	40,51/pc.	68	73021100	8,57/m	52	73031600	76,56/m	60	73054100	79,53/pc.	68
70056215	47,64/pc.	68	73021100	8,57/m	84	73031600	76,56/m	84	73054150	99,35/pc.	68
70056220	62,98/pc.	68	73021150	11,11/m	52	73032100	48,04/pc.	62	73054200	97,28/pc.	68

# Index

référence	prix en €	page	référence	prix en €	page	référence	prix en €	page	référence	prix en €	page
73054300	171,31/pc.	68	75234600	sur demande	57	76120009	6,51/pc.	35	44202004/2	91,29/pc.	213
73054400	221,45/pc.	68	75423200	sur demande	50	76452100	60,69/m	65	44202004/4	91,29/pc.	213
73054500	277,22/pc.	68	75423300	sur demande	50	76452150	61,33/m	65	46100001/1	23,41/pc.	220
73054600	327,57/pc.	68	75423400	sur demande	50	76452200	84,66/m	65	46100001/3	23,41/pc.	220
73055100	47,79/pc.	68	75423500	sur demande	50	76452300	106,69/m	65	46100002/1	24,15/pc.	220
73055150	54,06/pc.	68	75423600	sur demande	50	76452400	108,87/m	65	46100002/3	24,15/pc.	220
73055200	62,98/pc.	68	75424200	sur demande	50	76452500	149,14/m	65	46101001F1	47,15/pc.	220
73055300	91,51/pc.	68	75424300	sur demande	50	76452600	188,85/m	65	46101001F3	47,15/pc.	220
73055400	112,39/pc.	68	75424400	sur demande	50	76552100	58,99/m	65	46102001F1	53,23/pc.	220
73055500	135,72/pc.	68	75424500	sur demande	50	76552150	61,56/m	65	46102001F3	53,23/pc.	220
73055600	203,05/pc.	68	75424600	sur demande	50	76552200	84,80/m	65	46203002F1	80,63/pc.	220
73056100	68,11/pc.	68	75433200	sur demande	58	76552300	106,91/m	65	46203002F3	80,63/pc.	220
73056150	71,60/pc.	68	75433300	sur demande	58	76552400	109,05/m	65	74109001F3	183,27/pc.	222
73056200	88,43/pc.	68	75433400	sur demande	58	76552500	149,91/m	65	74109002F3	192,42/pc.	222
73056300	113,54/pc.	68	75433500	sur demande	58	76552600	189,56/m	65	74109003F3	221,61/pc.	222
73056400	173,59/pc.	68	75433600	sur demande	58	89010000	1,22/pc.	86	74109004F3	230,64/pc.	222
73056500	237,92/pc.	68	75434200	sur demande	58	89011000	132,20/pc.	86	74109005F3	274,83/pc.	222
73056600	301,10/pc.	68	75434300	sur demande	58	91112001	6,89/pc.	224	74109006F3	274,16/pc.	222
75121100	7,81/m	50	75434400	sur demande	58	91112002	10,73/pc.	224	91110006F2	18,55/pc.	226
75121150	9,70/m	50	75434500	sur demande	58	91112003	4,72/pc.	225	91110006F6	23,48/pc.	226
75121200	12,83/m	50	75434600	sur demande	58	91112004	5,31/pc.	225	91110007F2	23,43/pc.	226
75121300	17,00/m	50	75522100	9,53/m	49	92114001	44,81/set	221	91110007F6	29,33/pc.	226
75122060	9,53/m	50	75522100	9,53/m	119	92114002	17,74/pc.	221	91110008/2	17,97/pc.	226
75122100	9,53/m	50	75522150	12,73/m	49	92114003	15,70/set	221	91110008/6	22,99/pc.	226
75122150	12,73/m	50	75522150	12,73/m	119	92114004	14,90/set	221	91110009/2	20,42/pc.	226
75122200	13,80/m	50	75522200	13,80/m	49	92114007	20,37/set	221	91110009/6	25,23/pc.	226
75122300	18,37/m	50	75522200	13,80/m	119	93910002	2,00/pc.	51	91110010/2	24,81/pc.	226
75122400	26,53/m	50	75522300	18,37/m	49	93910003	sur demande	51	91110010/6	30,88/pc.	226
75122500	31,15/m	50	75522300	18,37/m	119	93910012	2,11/pc.	51	91110012/2	24,59/pc.	226
75122600	49,46/m	50	75522400	26,53/m	49	93910013	sur demande	51	91110012/6	30,65/pc.	226
75131100	22,19/m	58	75522400	26,53/m	119	93930002	2,91/pc.	59	91110014/2	30,58/pc.	226
75131150	25,45/m	58	75522500	31,15/m	49	93930003	sur demande	59	91110014/6	32,75/pc.	226
75131200	30,87/m	58	75522600	36,57/m	49	93930012	2,52/pc.	59	91110016F2	24,81/pc.	226
75131300	40,56/m	58	75821100	7,81/m	49	93930013	sur demande	59	91110016F6	30,39/pc.	226
75132060	24,99/m	58	75821150	9,70/m	49	93950002	7,27/pc.	65	91110018F2	29,73/pc.	226
75132100	24,99/m	58	75821200	12,83/m	49	93950012	7,56/pc.	65	91110018F6	37,11/pc.	226
75132150	32,47/m	58	75821300	17,00/m	49	26103001F1	148,88/pc.	218	91110020/2	20,91/pc.	226
75132200	34,47/m	58	75822100	8,22/m	49	26103001F3	148,88/pc.	218	91110020/6	25,86/pc.	226
75132300	44,11/m	58	75822150	10,84/m	49	26103002F1	148,88/pc.	218	91110010/2	4,46/pc.	225
75132400	82,84/m	58	75822200	12,26/m	49	26103002F3	148,88/pc.	218	91111002/2	2,43/pc.	225
75132500	93,39/m	58	75822300	15,97/m	49	26103003F1	185,99/pc.	218	91111002/6	2,59/pc.	225
75132600	107,20/m	58	75822400	19,97/m	49	26103003F3	185,99/pc.	218	91111003/2	2,43/pc.	225
75223200	sur demande	49	75822500	28,01/m	49	26103006F1	185,99/pc.	219	91111003/6	2,59/pc.	225
75223300	sur demande	49	75822600	32,80/m	49	26103006F3	185,99/pc.	219	91111005/2	3,99/pc.	225
75223400	sur demande	49	75831100	19,92/m	57	26106005F1	197,58/pc.	219	91113001/1	sur demande	223
75223500	sur demande	49	75831150	24,81/m	57	26106005F3	197,58/pc.	219	91113001/3	sur demande	223
75223600	sur demande	49	75831200	30,92/m	57	32102001F1	52,26/pc.	214	91113002/1	sur demande	223
75224200	sur demande	49	75831300	41,42/m	57	32102001F3	52,26/pc.	214	91113002/3	sur demande	223
75224300	sur demande	49	75832100	21,06/m	57	32102002F1	56,40/pc.	214	91113003/1	10,73/pc.	223
75224400	sur demande	49	75832150	26,30/m	57	32102002F3	56,40/pc.	214	91113003/3	10,73/pc.	223
75224500	sur demande	49	75832200	30,30/m	57	32112001F1	48,75/pc.	216	91113004/1	32,30/pc.	223
75224600	sur demande	49	75832300	40,51/m	57	32112001F3	48,75/pc.	216	91113004/3	32,30/pc.	223
75232100	24,88/m	57	75832400	51,64/m	57	32112002F1	44,32/pc.	216	91113005/1	12,89/pc.	223
75232100	24,88/m	119	75832500	63,27/m	57	32112002F3	44,32/pc.	216	91113005/3	12,89/pc.	223
75232150	29,38/m	57	75832600	72,75/m	57	32112004F1	54,60/pc.	217	91113006/1	10,54/pc.	223
75232150	29,38/m	119	76011004	13,48/m	34	32112004F3	54,60/pc.	217	91113006/3	10,54/pc.	223
75232200	35,32/m	57	76011006	24,70/m	34	32112005F1	57,71/pc.	217	91113007/1	3,30/pc.	223
75232200	35,32/m	119	76011504	16,01/m	34	32112005F3	57,71/pc.	217	91113007/3	3,30/pc.	223
75232300	44,96/m	57	76012004	18,35/m	34	33106003F1	68,70/pc.	214	91113009/1	16,20/pc.	223
75232300	44,96/m	119	76012006	32,40/m	34	33106003F3	68,70/pc.	214	91113009/3	16,20/pc.	223
75232400	58,08/m	57	76012504	22,00/m	34	34101003F1	49,82/pc.	216	91113010/1	45,12/pc.	224
75232400	58,08/m	119	76013004	24,05/m	34	34101003F3	49,82/pc.	216	91113010/3	45,12/pc.	224
75232500	76,74/m	57	76013005	30,21/m	34	34101005F1	63,37/pc.	217	91113011/1	5,26/pc.	224
75232600	91,11/m	57	76013006	42,55/m	34	34101005F3	63,37/pc.	217	91113011/3	5,26/pc.	224
75233200	sur demande	57	76014004	31,23/m	34	44101004/1	88,33/pc.	215	91113012/1	4,26/pc.	224
75233300	sur demande	57	76014005	38,17/m	34	44101004/2	88,33/pc.	215	91113012/3	4,26/pc.	224
75233400	sur demande	57	76014006	51,65/m	34	44101004/4	88,33/pc.	215	91113013/1	0,92/pc.	224
75233500	sur demande	57	76015004	43,05/m	34	44101006/1	99,27/pc.	215	91113013/3	0,92/pc.	224
75233600	sur demande	57	76015005	53,72/m	34	44101006/2	99,27/pc.	215	91113014/1	0,78/pc.	224
75234200	sur demande	57	76015006	62,11/m	34	44101006/4	99,27/pc.	215	91113014/3	0,78/pc.	224
75234300	sur demande	57	76016004	49,58/m	34	44201004/1	72,97/pc.	213	92114001/1	37,58/set	221
75234400	sur demande	57	76016005	62,18/m	34	44201004/2	72,97/pc.	213	92114001/3	37,58/set	221
75234500	sur demande	57	76016006	72,75/m	34	44201004/4	72,97/pc.	213	92114002/1	16,95/pc.	221



# Index

référence	prix en €	page	référence	prix en €	page	référence	prix en €	page	référence	prix en €	page
92114002/3	16,95/pc.	221	K8404HFHB	17,46/pc.	179	K8504HFHB	15,46/pc.	203	K8634HB	2,59/pc.	201
92114005/1	10,21/set	221	K8405HB	14,15/pc.	179	K8505HB	5,96/pc.	202	K8634HFHB	8,13/pc.	201
92114005/3	10,21/set	221	K8405HFHB	17,46/pc.	179	K8505HFHB	15,46/pc.	203	K8635HB	2,59/pc.	201
92114006/1	10,21/set	221	K8406HB	14,15/pc.	179	K8506HB	5,96/pc.	202	K8635HFHB	8,13/pc.	201
92114006/3	10,21/set	221	K8406HFHB	17,46/pc.	179	K8506HFHB	15,46/pc.	203	K8636HB	2,59/pc.	201
BODO NL	298,79/pc.	141	K8407HB	5,58/pc.	179	K8511HB	5,52/pc.	203	K8636HFHB	8,13/pc.	201
BODO NL-CR	547,39/pc.	141	K8407HFHB	9,92/pc.	179	K8512HB	5,52/pc.	203	K8641HB	2,37/pc.	201
BODO NL-MS	403,26/pc.	141	K8440-11HB	3,37/pc.	187	K8513HB	7,29/pc.	203	K8641HFHB	7,36/pc.	202
BODO NL-SW	403,26/pc.	141	K8440-12HB	4,41/pc.	187	K8514/EKDHB	7,29/pc.	203	K8642HB	2,37/pc.	201
BODO TL-G	51,83/pc.	141	K8440-13HB	7,19/pc.	187	K8514HB	7,29/pc.	203	K8642HFHB	7,36/pc.	202
BODO TL-S	51,83/pc.	141	K8441HB	15,02/pc.	185	K8515HB	7,29/pc.	203	K8643HB	3,12/pc.	201
CEZ070	7,24/pc.	43	K8442HB	15,02/pc.	185	K8516HB	7,29/pc.	203	K8643HFHB	8,26/pc.	202
CEZ100	7,76/pc.	43	K8443HB	19,69/pc.	185	K8541HB	12,15/pc.	188	K8644HB	3,12/pc.	201
CEZ120	8,10/pc.	43	K8444HB	19,69/pc.	185	K8542HB	12,15/pc.	188	K8644HFHB	8,26/pc.	202
CEZ150	11,14/pc.	43	K8445HB	19,69/pc.	185	K8543HB	18,32/pc.	188	K8645HB	3,12/pc.	201
CEZ200	12,39/pc.	43	K8446HB	19,69/pc.	185	K8544HB	12,15/pc.	188	K8645HFHB	8,26/pc.	202
CEZ300	19,13/pc.	43	K8447HB	8,57/pc.	185	K8545HB	12,15/pc.	188	K8646HB	3,12/pc.	201
CEZ400	25,01/pc.	43	K8450-11HB	3,55/pc.	187	K8546HB	12,15/pc.	188	K8646HFHB	8,26/pc.	202
IDT0003	222,41/pc.	210	K8450-11HFHB	6,04/pc.	187	K8550-11HB	3,54/pc.	192	K8651HB	2,78/pc.	202
IDT0004	222,41/pc.	210	K8450-12HB	4,41/pc.	187	K8550-12HB	4,41/pc.	192	K8652HB	2,78/pc.	202
IDT0009	432,87/pc.	209	K8450-12HFHB	7,36/pc.	187	K8550-13HB	5,52/pc.	192	K8653HB	3,77/pc.	202
IDT0010	432,87/pc.	209	K8450-13HB	7,19/pc.	187	K8551HB	17,45/pc.	189	K8653RHB	3,77/pc.	202
IDT0011	129,57/pc.	209	K8450-13HFHB	11,77/pc.	187	K8552HB	17,45/pc.	189	K8654HB	3,77/pc.	202
IDT0012	129,57/pc.	209	K8451HB	9,94/pc.	183	K8553HB	17,45/pc.	189	K8654RHB	3,77/pc.	202
IDT0019	407,40/pc.	207	K8451HFHB	11,81/pc.	183	K8554HB	16,55/pc.	189	K8655HB	3,77/pc.	202
IDT0020	429,32/pc.	207	K8452HB	9,27/pc.	183	K8555HB	16,55/pc.	189	K8656HB	3,77/pc.	202
IDT0021	461,40/pc.	207	K8452HFHB	11,26/pc.	183	K8556HB	16,55/pc.	189	K8671HB	0,95/pc.	199
IDT0022	407,40/pc.	207	K8453HB	15,22/pc.	183	K8560-11HB	4,02/pc.	192	K8672HB	0,95/pc.	199
IDT0023	429,32/pc.	207	K8453HFHB	17,18/pc.	183	K8560-12HB	5,19/pc.	192	K8673HB	1,41/pc.	199
IDT0024	461,40/pc.	207	K8454HB	15,22/pc.	183	K8560-13HB	6,85/pc.	192	K8674HB	1,41/pc.	199
IDT2917	9,65/pc.	206	K8454HFHB	17,18/pc.	183	K8561HB	18,59/pc.	190	K8675HB	1,41/pc.	199
IDT2941	129,57/pc.	208	K8455HB	16,11/pc.	183	K8562HB	18,59/pc.	190	K8676HB	1,41/pc.	199
IDT2942	129,57/pc.	208	K8455HFHB	18,16/pc.	183	K8563HB	32,75/pc.	190	K8681HB	0,75/pc.	198
IDT6298	166,81/pc.	210	K8456HB	15,22/pc.	183	K8564HB	18,59/pc.	190	K8682HB	0,75/pc.	198
IDT6299	166,81/pc.	210	K8456HFHB	17,18/pc.	183	K8565HB	18,59/pc.	190	K8683HB	1,12/pc.	198
IDT6300	340,13/pc.	208	K8457HB	5,52/pc.	183	K8566HB	18,59/pc.	190	K8684HB	1,12/pc.	198
IDT6301	340,13/pc.	208	K8457HFHB	6,85/pc.	183	K8571HB	21,26/pc.	191	K8685HB	1,12/pc.	198
IDT6302	290,91/pc.	206	K8461HB	11,25/pc.	184	K8572HB	21,26/pc.	191	K8686HB	1,12/pc.	198
IDT6303	303,71/pc.	206	K8462HB	11,25/pc.	184	K8573HB	35,43/pc.	191	K8691HB	1,04/pc.	200
IDT6304	322,33/pc.	206	K8463HB	18,10/pc.	184	K8574HB	21,26/pc.	191	K8692HB	1,04/pc.	200
IDT6305	290,91/pc.	206	K8464HB	18,10/pc.	184	K8575HB	21,26/pc.	191	K8693HB	1,60/pc.	200
IDT6306	303,71/pc.	206	K8465HB	18,10/pc.	184	K8576HB	21,26/pc.	191	K8694HB	1,60/pc.	200
IDT6307	322,33/pc.	206	K8466HB	18,10/pc.	184	K8581HB	5,89/pc.	203	K8695HB	1,60/pc.	200
IDT6893	12,82/pc.	207	K8467HB	6,41/pc.	184	K8582HB	5,89/pc.	203	K8696HB	1,60/pc.	200
IDT6894	11,76/pc.	206	K8471HB	11,03/pc.	180	K8583HB	8,83/pc.	203	K8711HB	1,61/pc.	198
IDT6894	11,76/pc.	207	K8472HB	11,03/pc.	180	K8584/EKDHB	8,83/pc.	203	K8712/2HB	1,88/pc.	198
IDT6894	11,76/pc.	208	K8473HB	19,42/pc.	180	K8584HB	8,83/pc.	203	K8713/2HB	1,88/pc.	198
IDT6894	11,76/pc.	209	K8474HB	19,42/pc.	180	K8585HB	8,83/pc.	203	K8714HB	1,61/pc.	198
IDT6894	11,76/pc.	210	K8475HB	19,42/pc.	180	K8586HB	8,83/pc.	203	K8715HB	1,88/pc.	198
IDT7218	444,48/pc.	206	K8476HB	19,42/pc.	180	K8601HB	1,04/pc.	201	K8716HB	1,88/pc.	198
IDT7219	702,71/pc.	207	K8477HB	7,72/pc.	180	K8602HB	1,04/pc.	201	K8731HB	0,93/pc.	198
IDT7239	444,48/pc.	206	K8481HB	12,36/pc.	181	K8603HB	1,58/pc.	201	K8732HB	0,93/pc.	198
IDT7240	702,71/pc.	207	K8482HB	12,36/pc.	181	K8604HB	1,58/pc.	201	K8733HB	1,41/pc.	198
K5216EZN	169,05/bt.	122	K8483HB	19,86/pc.	181	K8605HB	1,58/pc.	201	K8734HB	1,41/pc.	198
K5220ZNF	187,73/bt.	122	K8484HB	19,86/pc.	181	K8606HB	1,58/pc.	201	K8735HB	1,41/pc.	198
K5225ZNF	205,95/bt.	122	K8485HB	19,86/pc.	181	K8621HB	1,00/pc.	199	K8736HB	1,41/pc.	198
K5232ZNF	112,69/bt.	122	K8486HB	19,86/pc.	181	K8621HFHB	3,31/pc.	200	K8791HB	1,06/pc.	198
K5240ZNF	103,32/bt.	122	K8487HB	8,82/pc.	181	K8622HB	1,00/pc.	199	K8792HB	1,06/pc.	198
K5250ZNF	117,43/bt.	122	K8491HB	16,35/pc.	182	K8622HFHB	3,31/pc.	200	K8793HB	1,52/pc.	198
K5263ZNF	217,89/bt.	122	K8492HB	16,55/pc.	182	K8623HB	1,58/pc.	199	K8794HB	1,52/pc.	198
K6708PO	193,73/bt.	122	K8493HB	26,05/pc.	182	K8623HFHB	4,83/pc.	200	K8795HB	1,52/pc.	198
K6710PO	202,95/bt.	122	K8494HB	26,05/pc.	182	K8624HB	1,58/pc.	199	K8796HB	1,52/pc.	198
K6712PO	212,18/bt.	122	K8495HB	26,05/pc.	182	K8624HFHB	4,83/pc.	200	K8821LHB	2,70/pc.	194
K6716EDPO	319,19/bt.	122	K8496HB	26,05/pc.	182	K8625HB	1,58/pc.	199	K8821PHB	2,70/pc.	194
K6716EPO	385,14/bt.	122	K8497HB	11,71/pc.	182	K8625HFHB	4,83/pc.	200	K8822HB	2,70/pc.	194
K8135PO	45,20/pc.	123	K8501HB	4,19/pc.	202	K8626HB	1,58/pc.	199	K8823/13LHB	3,67/pc.	195
K8401HB	7,09/pc.	179	K8501HFHB	11,71/pc.	203	K8626HFHB	4,83/pc.	200	K8823/13PHB	3,67/pc.	195
K8401HFHB	9,92/pc.	179	K8502HB	4,19/pc.	202	K8631HB	1,91/pc.	201	K8824/12HB	3,67/pc.	195
K8402HB	7,09/pc.	179	K8502HFHB	11,71/pc.	203	K8631HFHB	5,78/pc.	201	K8824/40HB	3,67/pc.	195
K8402HFHB	9,92/pc.	179	K8503HB	5,96/pc.	202	K8632HB	1,91/pc.	201	K8824/41HB	3,67/pc.	195
K8403HB	14,15/pc.	179	K8503HFHB	15,46/pc.	203	K8632HFHB	5,78/pc.	201	K8824/43HB	3,67/pc.	195
K8403HFHB	17,46/pc.	179	K8504/EKDHB	5,41/pc.	202	K8633HB	2,59/pc.	201	K8824/44HB	3,67/pc.	195
K8404HB	14,15/pc.	179	K8504HB	5,73/pc.	202	K8633HFHB	8,13/pc.	201	K8825HB	3,67/pc.	194

# Index

référence	prix en €	page	référence	prix en €	page	référence	prix en €	page	référence	prix en €	page
K8826HB	3,67/pc.	194	KEKE140X60HD	21,08/m	190	KLV11X10HD	0,91/m	198	KSK40X33S	26,39/m	186
K8833HB	2,80/pc.	197	KEKE180X60HD	25,95/m	191	KLV11X10P2	1,72/m	198	KSK40X33S	26,39/m	192
K8833KB	2,80/pc.	197	KEKE60X60HD	9,74/m	188	KLV18X13HD	1,25/m	198	KVK20	257,00/pc.	197
K8833LB	2,80/pc.	197	KKPEKEHB	4,87/pc.	192	KLV18X13P2	2,23/m	198	PDC100-3	4,45/pc.	164
K8834HB	2,55/pc.	197	KKPPKHB	4,54/pc.	187	KLV18X13SD	1,69/m	198	PDC135-3	4,72/pc.	167
K8834KB	2,55/pc.	197	KKPPKHFHB	6,69/pc.	187	KLV18X13TD	1,69/m	198	PK1010-3	24,42/m	164
K8834LB	2,55/pc.	197	KKSK100PO	66,42/pc.	123	KLV24X22HD	1,98/m	198	PK1310-3	31,82/m	167
K8843HB	3,11/pc.	197	KKSK1252P06	89,94/pc.	123	KLV24X22P2	3,15/m	198	PKE100-3	5,11/pc.	164
K8843KB	3,11/pc.	197	KKSK125DPO	80,26/pc.	123	KLV40X15HD	2,50/m	198	PKE135-3	5,36/pc.	167
K8843LB	3,11/pc.	197	KKSK125P010	80,26/pc.	123	KLV40X15P2	3,90/m	198	PKJ1	1,78/pc.	164
K8844HB	2,94/pc.	197	KKSK125P06P	92,25/pc.	123	KLZ15X12HD	1,24/m	196	PKJ1	1,78/pc.	167
K8844KB	2,94/pc.	197	KKSK1752P010	115,31/pc.	123	KLZ15X12KD	1,29/m	196	PROF30-15-1.5-4/GS	4,91/m	106
K8844LB	2,94/pc.	197	KKSK175DPO	129,15/pc.	123	KLZ15X12HD	1,24/m	196	PROF30-15-2.0-2/GS	6,16/m	106
K8855/3HB	1,99/pc.	196	KKSK175P010P	119,93/pc.	123	KOKSPLDB	1,77/pc.	107	PROF41-21-2.0-6/HD	11,73/m	106
K8855HB	1,99/pc.	196	KKSK175P016	115,31/pc.	123	KOKSPSDB	2,75/pc.	107	PROF41-21-2.5-3/HD	16,56/m	106
K8856HB	1,99/pc.	196	KL-42W	176,86/pc.	197	KPEKD40C	2,76/m	186	PROF41-21-2.5-6/HD	16,56/m	106
K8861LHB	3,58/pc.	193	KLH15X10HD	0,94/m	198	KPEKD40HFC	7,07/m	186	PROF41-41-2.0-6/HD	20,13/m	106
K8861LI1	7,73/pc.	193	KLH15X10P2	1,75/m	198	KPEKE60C	5,96/m	186	PROF41-41-2.5-3/HD	22,88/m	106
K8861LI2	7,73/pc.	193	KLH60X40HD	7,46/m	202	KPEKE60C	5,96/m	192	PROF41-41-2.5-6/HD	22,88/m	106
K8861LSD	7,73/pc.	193	KLHD17X17HD	1,30/m	199	KPEP60/KS	27,58/m	186	PROF41-41-2.5-6/RVS316	96,82/m	107
K8861PHB	3,58/pc.	193	KLHD17X17P2	1,98/m	199	KPEP60/KS	27,58/m	192	PROF41-41-2.5-6/RVS316P	101,19/m	107
K8861PI1	7,73/pc.	193	KLHD20X10HD	1,19/m	199	KPEP60HD	11,77/m	186	PROFD41-21-2.0-6/HD	30,04/m	107
K8861PI2	7,73/pc.	193	KLHD20X10HFHD	4,21/m	199	KPEP60HD	11,77/m	192	PROFD41-41-2.5-6/HD	50,34/m	107
K8861PSD	7,73/pc.	193	KLHD20X10P2	2,08/m	199	KPK110X70DHD	22,54/m	183	SNA 6x30/5	158,21/bt.	138
K8865HB	3,58/pc.	193	KLHD20X20HD	1,61/m	199	KPK110X70DHFHD	61,18/m	183	TB1010-1	49,86/m	163
K8865I1	7,73/pc.	193	KLHD20X20HFHD	6,49/m	200	KPK120X55DHD	26,58/m	180	TB1010-3	49,86/m	163
K8865I2	7,73/pc.	193	KLHD20X20I1	15,01/m	199	KPK140X70DHD	27,34/m	184	TB1032-3	56,86/m	175
K8865SD	3,96/pc.	193	KLHD20X20I2	15,01/m	199	KPK160X65DHD	36,44/m	181	TB1040-1	53,90/m	165
K8866HB	3,58/pc.	193	KLHD20X20P2	2,76/m	199	KPK170X70DHD	33,16/m	185	TB1040-3	53,90/m	165
K8866I1	7,73/pc.	193	KLHD20X20SD	2,01/m	199	KPK210X70DHD	47,42/m	182	TB1310-1	51,48/m	166
K8866I2	7,73/pc.	193	KLHD20X20TD	2,01/m	199	KPK90X55DHD	15,38/m	179	TB1310-3	51,48/m	166
K8866SD	3,96/pc.	193	KLHD25X15HD	1,59/m	200	KPK90X55DHFHD	41,51/m	179	TB1340-1	57,09/m	168
K8873HB	3,65/pc.	197	KLHD25X15P2	2,76/m	200	KPKS70/60	9,70/m	186	TB1340-3	57,09/m	168
K8873KB	3,65/pc.	197	KLHD25X20HD	1,95/m	200	KPKS70/60	9,70/m	192	TB1710-1	65,26/m	169
K8873LB	3,65/pc.	197	KLHD25X20P2	3,12/m	200	KPLSK	4,69/pc.	186	TB1710-3	65,26/m	169
K8874HB	3,25/pc.	197	KLHD30X25HD	2,19/m	200	KPN80X252ZHB	7,29/pc.	194	TB1740-1	66,56/m	170
K8874KB	3,25/pc.	197	KLHD30X25P2	3,25/m	200	KPN80X25HB	7,06/pc.	194	TB1740-3	66,56/m	170
K8874LB	3,25/pc.	197	KLHD32X15HD	1,85/m	201	KPNEKES	45,46/pc.	192	TB2210-1	88,03/m	171
K8911HB	1,06/pc.	200	KLHD32X15P2	3,09/m	201	KPNLP352ZHB	6,16/pc.	193	TB2210-3	88,03/m	171
K8912HB	1,06/pc.	200	KLHD40X20HD	2,53/m	201	KPNLP352Z1I	11,92/pc.	193	TB2240-1	109,54/m	172
K8913HB	1,52/pc.	200	KLHD40X20HFHD	10,70/m	201	KPNLP352Z12	11,92/pc.	193	TB2240-3	109,54/m	172
K8914HB	1,52/pc.	200	KLHD40X20I1	17,45/m	201	KPNLP352ZSD	9,78/pc.	193	TB45-1	11,19/m	165
K8915HB	1,52/pc.	200	KLHD40X20I2	17,45/m	201	KPNPKS	45,46/pc.	187	TB45-1	11,19/m	168
K8916HB	1,52/pc.	200	KLHD40X20P2	3,96/m	201	KPSK1HB	3,43/pc.	186	TB45-1	11,19/m	170
K8921HB	0,95/pc.	199	KLHD40X20SD	3,09/m	201	KQP45X45CBB	12,65/pc.	187	TB45-1	11,19/m	172
K8921HFHB	3,05/pc.	199	KLHD40X20TD	3,09/m	201	KQP45X45CHB	11,75/pc.	187	TB45-3	11,19/m	165
K8922HB	0,95/pc.	199	KLHD40X40HD	4,06/m	201	KRK-0VK20LA	9,72/pc.	204	TB45-3	11,19/m	168
K8922HFHB	3,05/pc.	199	KLHD40X40HFHD	15,90/m	202	KRK-0VK30LB	10,21/pc.	204	TB45-3	11,19/m	170
K8923HB	1,41/pc.	199	KLHD40X40SD	7,35/m	201	KRK-0VK40LB	11,81/pc.	204	TB45-3	11,19/m	172
K8923HFHB	4,50/pc.	199	KLHD40X40TD	7,35/m	201	KRK-ST12H25	2,38/m	204	TB80-1	15,68/m	163
K8924HB	1,41/pc.	199	KLHD50X20/1HD	3,50/m	202	KRK-ST22H25	5,99/m	204	TB80-1	15,68/m	166
K8924HFHB	4,50/pc.	199	KLHD50X20/2HD	3,77/m	202	KRK-ST6H25	1,48/m	204	TB80-1	15,68/m	169
K8925HB	1,41/pc.	199	KLHD50X20HD	3,30/m	202	KRK100X60LD	12,63/m	204	TB80-1	15,68/m	170
K8925HFHB	4,50/pc.	199	KL035HD	5,08/m	197	KRK125X75HFLD	46,99/m	204	TB80-1	15,68/m	171
K8926HB	1,41/pc.	199	KL035KD	5,08/m	197	KRK30X30LD	5,85/m	204	TB80-1	15,68/m	172
K8926HFHB	4,50/pc.	199	KL035LD	5,08/m	197	KRK30X40LD	6,90/m	204	TB80-1	15,68/m	176
K8931HB	1,54/pc.	200	KL035P2	5,35/m	197	KRK37.5X37.5HFLD	15,38/m	204	TB80-1	15,68/m	176
K8932HB	1,54/pc.	200	KL050HD	7,23/m	197	KRK37.5X50HFLD	18,41/m	204	TB80-3	15,68/m	163
K8933HB	2,18/pc.	200	KL050KD	7,23/m	197	KRK40X100LD	16,69/m	204	TB80-3	15,68/m	166
K8934HB	2,18/pc.	200	KL050LD	7,23/m	197	KRK40X60LD	6,52/m	204	TB80-3	15,68/m	169
K8935HB	2,18/pc.	200	KL050P2	8,12/m	197	KRK40X80LD	8,82/m	204	TB80-3	15,68/m	170
K8936HB	2,18/pc.	200	KL075HD	8,89/m	197	KRK50X50HFLD	19,27/m	204	TB80-3	15,68/m	171
K8991HB	1,99/pc.	202	KL075KD	8,89/m	197	KRK50X75HFLD	27,10/m	204	TB80-3	15,68/m	172
K8992HB	1,99/pc.	202	KL075LD	8,89/m	197	KRK60X60LD	8,45/m	204	TB80-3	15,68/m	175
K8993HB	2,83/pc.	202	KL075P2	11,08/m	197	KRK60X80LD	9,43/m	204	TB80-3	15,68/m	176
K8994HB	2,83/pc.	202	KLP35HD	8,67/m	193	KRK75X50HFLD	29,60/m	204	TB80-3	15,68/m	176
K8995HB	2,83/pc.	202	KLP35I1	16,74/m	193	KRK75X75HFLD	34,52/m	204	TBA10-1	55,69/m	176
K8996HB	2,83/pc.	202	KLP35I2	16,74/m	193	KRK80X100LD	20,13/m	204	TBA10-3	55,69/m	176
KEKD100X40HD	10,70/m	203	KLP35SD	12,75/m	193	KRK80X60LD	13,11/m	204	TBA18-1	98,13/m	176
KEKD120X40HD	12,65/m	203	KLP35TD	12,75/m	193	KSBE.3X35POGMT	62,73/sac	122	TBA18-3	98,13/m	176
KEKD80X40HD	9,08/m	202	KLP80X25HD	9,47/m	194	KSD2S	1,90/pc.	122	TBA202-1	16,00/m	175
KEKD80X40HFHD	27,90/m	203	KLPK80X25HD	9,72/m	194	KSK40X20S	23,54/m	186	TBA202-3	16,00/m	175
KEKE100X60HD	14,28/m	189	KLR30HB	9,82/m	196	KSK40X20S	23,54/m	192	TBA22-1	10,81/m	175

# Index

référence	prix en €	page	référence	prix en €	page	référence	prix en €	page	référence	prix en €	page
TBA22-3	10,81/m	175	TB0135-3	9,08/pc.	166	UBK 100-20S	48,37/m	130	UDEF-XLR 2	4,52/pc.	159
TBA302-1	30,17/m	175	TB0135-3	9,08/pc.	167	UBK 100-30S	57,88/m	130	UE 28-350S	13,33/pc.	133
TBA302-3	30,17/m	175	TB0135-3	9,08/pc.	168	UBK 100-40S	70,18/m	130	UE 38-350S	15,11/pc.	133
TBA32-1	11,36/m	175	TB0170-3	9,36/pc.	169	UBK 135-20S	53,53/m	130	UE 48-350S	17,49/pc.	133
TBA32-1	11,36/m	175	TB0170-3	9,36/pc.	170	UBK 135-30S	64,24/m	130	UEB3-R 2	3,21/pc.	149
TBA32-3	11,36/m	175	TB0220-3	9,74/pc.	171	UBK 135-40S	76,53/m	130	UEB3-R 5	3,79/pc.	149
TBA32-3	11,36/m	175	TB0220-3	9,74/pc.	172	UBK 170-20S	59,48/m	130	UEB3-R-G	43,04/pc.	139
TBA652-1	39,52/m	175	TBP100-1	12,76/pc.	163	UBK 170-30S	69,78/m	130	UEB3-R-S	43,04/pc.	139
TBA652-3	39,52/m	175	TBP100-1	12,76/pc.	165	UBK 170-40S	80,88/m	130	UEB3-V 2	3,16/pc.	149
TBC100-1	38,34/pc.	163	TBP100-3	12,76/pc.	163	UBKAB10F	250,99/pc.	130	UEB3-V 5	3,16/pc.	149
TBC100-1	38,34/pc.	165	TBP100-3	12,76/pc.	165	UBKAB5F	155,83/pc.	130	UEB3-V-G	40,96/pc.	139
TBC100-3	38,34/pc.	163	TBP135-1	13,68/pc.	166	UBKAB8F	203,41/pc.	130	UEB3-V-S	40,96/pc.	139
TBC100-3	38,34/pc.	164	TBP135-1	13,68/pc.	168	UBKD10 25F	394,92/m	130	UEBD 15-R E	339,01/set	142
TBC100-3	38,34/pc.	165	TBP135-3	13,68/pc.	166	UBKD10 35F	479,37/m	130	UEBD 15-RP E	496,03/set	142
TBC135-1	38,34/pc.	166	TBP135-3	13,68/pc.	168	UBKD10 45F	556,69/m	130	UEBD 15-V E	161,78/set	144
TBC135-1	38,34/pc.	168	TBP170-1	15,47/pc.	169	UBKD5 25F	298,57/m	130	UEBD 15-VP E	262,88/set	144
TBC135-3	38,34/pc.	166	TBP170-1	15,47/pc.	170	UBKD5 35F	336,63/m	130	UEBD 25-V E	172,48/set	144
TBC135-3	38,34/pc.	167	TBP170-3	15,47/pc.	169	UBKD5 45F	377,08/m	130	UEBD 35-R E	388,97/set	142
TBC135-3	38,34/pc.	168	TBP170-3	15,47/pc.	170	UBKD8 25F	358,04/m	130	UEBD 35-V E	205,79/set	144
TBC170-1	40,66/pc.	169	TBP220-1	17,04/pc.	171	UBKD8 35F	423,47/m	130	UEBD 45-V E	224,81/set	144
TBC170-1	40,66/pc.	170	TBP220-1	17,04/pc.	172	UBKD8 45F	484,13/m	130	UEBD1-2 15-V E	148,69/pc.	148
TBC170-3	40,66/pc.	169	TBP220-3	17,04/pc.	171	UBKDB5 25F	3,93/pc.	131	UEBD1-2 25-V E	158,21/pc.	148
TBC170-3	40,66/pc.	170	TBP220-3	17,04/pc.	172	UBKDB5 35F	4,47/pc.	131	UEBD2 15-V E	184,38/pc.	143
TBC220-1	43,09/pc.	171	TDH1	10,81/m	173	UBKDB5 45F	5,71/pc.	131	UEBD2 25-V E	199,83/pc.	143
TBC220-1	43,09/pc.	172	UA-1-1 113	1,37/pc.	152	UBKDB8 25F	4,16/pc.	131	UEBD2-R 3	2,86/pc.	149
TBC220-3	43,09/pc.	171	UA-3-1 226	2,50/pc.	152	UBKDB8 35F	4,88/pc.	131	UEBD2-R-G	31,59/pc.	140
TBC220-3	43,09/pc.	172	UA-B 113	1,42/pc.	153	UBKDB8 45F	6,02/pc.	131	UEBD2-R-S	31,59/pc.	140
TBD100-1	11,03/pc.	176	UA-B 226	2,61/pc.	153	UBKEB 100-20S	26,95/pc.	130	UEBD2-V 3	2,97/pc.	149
TBD100-3	11,03/pc.	176	UAA-B 22	1,31/pc.	153	UBKEB 100-30S	30,81/pc.	130	UEBD2-V-G	34,49/pc.	140
TBD180-1	12,49/pc.	176	UAA-B 45	1,37/pc.	153	UBKEB 100-40S	32,78/pc.	130	UEBD2-V-S	34,49/pc.	140
TBD180-3	12,49/pc.	176	UALS-2-1 113	15,17/pc.	153	UBKEB 135-20S	28,91/pc.	130	UEBD3-R 3	3,21/pc.	149
TBD30-1	9,79/pc.	175	UAM-1-1 113	1,78/pc.	152	UBKEB 135-30S	32,78/pc.	130	UEBD3-R-G	40,98/pc.	140
TBD30-3	9,79/pc.	175	UAM-2-1 113	1,61/pc.	152	UBKEB 135-40S	34,61/pc.	130	UEBD3-R-S	40,98/pc.	140
TBD65-1	9,89/pc.	175	UAM-4-1 226	2,80/pc.	152	UBKEB 170-20S	30,81/pc.	130	UEBD3-V 3	3,16/pc.	149
TBD65-3	9,89/pc.	175	UARM-2-1 118	2,33/pc.	151	UBKEB 170-30S	34,61/pc.	130	UEBD3-V-G	39,01/pc.	140
TBE1	9,62/pc.	174	UARM-3-1 118	2,26/pc.	151	UBKEB 170-40S	36,58/pc.	130	UEBD3-V-S	39,01/pc.	140
TBE100	12,05/pc.	174	UARM-3-KS1 118S	10,95/pc.	151	UBKIB10F	210,55/pc.	130	UEBDD 15-V E	304,52/pc.	141
TBE125	14,66/pc.	174	UAUS-1-1 113	2,86/pc.	153	UBKIB5F	134,42/pc.	130	UEBDD 25-V E	324,74/pc.	141
TBE20-1	10,55/m	174	UB 28-190S	6,78/pc.	132	UBKIB8F	172,48/pc.	130	UEBDD1-2 15-V E	135,61/pc.	141
TBE20-3	10,55/m	174	UB 28-250S	6,96/pc.	132	UBKM	35,86/pc.	138	UEBDD1-2 25-V E	137,99/pc.	141
TBE25	6,32/pc.	174	UB 28-350S	7,80/pc.	132	UBKPR10F	90,80/m	130	UEBDD2 15-V E	226,01/pc.	141
TBE3	3,14/pc.	174	UB 38-190S	6,96/pc.	132	UBKPR5F	57,88/m	130	UEBDD2 25-V E	235,52/pc.	141
TBE50	7,57/pc.	174	UB 38-250S	7,08/pc.	132	UBKPR8F	75,34/m	130	UEBDE3-R 6	28,31/pc.	150
TBE75	9,74/pc.	174	UB 38-350S	7,80/pc.	132	UBKPRV	4,28/pc.	131	UEBDE3-V 6	13,56/pc.	150
TBF1	5,84/pc.	173	UB 48-190S	7,08/pc.	132	UBKPRVE	5,30/pc.	131	UEBDM 15-R-WD	425,85/set	142
TBF11	1,35/pc.	173	UB 48-250S	7,32/pc.	132	UBKTR 100S	4,94/m	131	UEBDM 15-RP-WD	657,80/set	142
TBF12	14,38/pc.	173	UB 48-350S	7,97/pc.	132	UBKTR 135S	5,75/m	131	UEBDM 15-V-WD	254,56/set	144
TBF2	13,24/pc.	173	UBDEL	10,18/pc.	138	UBKTR 170S	6,56/m	131	UEBDM 15-VP-WD	416,33/set	144
TBJ1	4,44/pc.	173	UBDHB 38-122R	61,14/pc.	134	UBKV 100S	2,56/pc.	131	UEBDM 25-V-WD	292,62/set	144
TBJ8	0,48/pc.	174	UBDHB-Z	2,02/pc.	138	UBKV 135S	3,33/pc.	131	UEBDM 35-R-WD	493,65/set	142
TBK1	1,46/pc.	174	UBDHB190 28-160V	90,17/pc.	134	UBKV 170S	4,16/pc.	131	UEBDM 35-V-WD	303,33/set	144
TBL10-1	7,79/pc.	163	UBDHB190 38-160V	90,88/pc.	134	UBP-V 4S	36,82/pc.	145	UEBDM 45-V-WD	310,46/set	144
TBL10-1	7,79/pc.	165	UBDHB190 48-160V	91,59/pc.	134	UDEF-3PK 2	4,28/pc.	159	UEBDM3-R 6	36,04/pc.	150
TBL10-3	7,79/pc.	163	UBDHB250 28-185V	94,63/pc.	134	UDEF-5PCOM 1	4,28/pc.	159	UEBDM3-V 6	25,45/pc.	150
TBL10-3	7,79/pc.	164	UBDHB250 28-259R	103,14/pc.	134	UDEF-5PK 1	4,28/pc.	159	UEBDS 25-V6 E	210,55/set	145
TBL10-3	7,79/pc.	165	UBDHB250 28-259V	102,37/pc.	134	UDEF-AMP 3	4,28/pc.	157	UEBDS 35-R6 E	510,30/set	143
TBL13-1	7,79/pc.	166	UBDHB250 38-185V	97,77/pc.	134	UDEF-AMP SL3	4,28/pc.	157	UEBDS 35-V6 E	245,04/set	145
TBL13-1	7,79/pc.	168	UBDHB250 38-259R	106,05/pc.	134	UDEF-B	4,28/pc.	159	UEBDS 35-V8 E	247,41/set	145
TBL13-3	7,79/pc.	166	UBDHB250 38-259V	105,22/pc.	134	UDEF-BTR 3	4,28/pc.	157	UEBDS 45-V6 E	264,07/set	145
TBL13-3	7,79/pc.	167	UBDHB250 48-185V	101,11/pc.	134	UDEF-COR 3	4,28/pc.	157	UEBDS 45-V8 E	266,45/set	145
TBL13-3	7,79/pc.	168	UBDHB250 48-259R	108,78/pc.	134	UDEF-DSUB9 1	4,52/pc.	159	UEBDSM 25-V6-WD	346,15/set	145
TBL17-1	7,79/pc.	169	UBDHB250 48-259V	108,08/pc.	134	UDEF-GG45 3	4,28/pc.	158	UEBDSM 35-R6-WD	606,66/set	143
TBL17-1	7,79/pc.	170	UBDHB350 28-259R	110,54/pc.	134	UDEF-HAR PL3	4,28/pc.	157	UEBDSM 35-V6-WD	354,48/set	145
TBL17-3	7,79/pc.	169	UBDHB350 28-259V	110,98/pc.	134	UDEF-KEL 3	10,18/pc.	158	UEBDSM 35-V8-WD	358,04/set	145
TBL17-3	7,79/pc.	170	UBDHB350 28-308R	114,14/pc.	134	UDEF-KM 1	4,88/pc.	159	UEBDSM 45-V6-WD	369,94/set	145
TBL22-1	7,79/pc.	171	UBDHB350 38-259R	114,95/pc.	134	UDEF-KR 2	4,28/pc.	158	UEBDSM 45-V8-WD	374,70/set	145
TBL22-1	7,79/pc.	172	UBDHB350 38-259V	114,79/pc.	134	UDEF-LEX 2	4,28/pc.	158	UEBDSM1-2 15-V8-WD	291,43/pc.	148
TBL22-3	7,79/pc.	171	UBDHB350 38-308R	118,23/pc.	134	UDEF-RM 2	4,28/pc.	158	UEBS 20S	157,61/m	128
TBL22-3	7,79/pc.	172	UBDHB350 48-259R	119,16/pc.	134	UDEF-RMSC 2	4,28/pc.	158	UEBS 30S	173,67/m	128
TBM1	6,75/pc.	173	UBDHB350 48-259V	121,33/pc.	134	UDEF-RMSC 3	4,28/pc.	158	UEBS 40S	189,73/m	128
TB0100-3	8,54/pc.	163	UBDHB350 48-308R	122,52/pc.	134	UDEF-SCD 4	4,28/pc.	157	UEBSES 100-20S	26,17/pc.	128
TB0100-3	8,54/pc.	164	UBE-AMPSL-TV	12,32/pc.	151	UDEF-SCS 4	4,28/pc.	157	UEBSES 100-30S	28,55/pc.	128
TB0100-3	8,54/pc.	165	UBE-KS 2	12,32/pc.	151	UDEF-SYS 2	4,28/pc.	158	UEBSES 100-40S	30,92/pc.	128

# Index

référence	prix en €	page	référence	prix en €	page	référence	prix en €	page	référence	prix en €	page
UEBSES 60-20S	24,98/pc.	128	UEKDD2 15-V E	318,79/pc.	141	UK 2-38-250S	47,58/m	132	UM 38-350S	13,33/pc.	133
UEBSES 60-30S	27,36/pc.	128	UEKDD2 25-V E	339,01/pc.	141	UK 2-38-350S	64,64/m	132	UM 48-190S	11,48/pc.	133
UEBSES 60-40S	29,74/pc.	128	UEKDE3-R 6	30,22/pc.	150	UK 2-48-190S	44,80/m	132	UM 48-250S	12,07/pc.	133
UEBSMA 20S	31,64/pc.	129	UEKDE3-V 6	17,61/pc.	150	UK 2-48-250S	49,17/m	132	UM 48-350S	13,44/pc.	133
UEBSMA 30S	32,24/pc.	129	UEKDS 25-V6 E	280,73/set	145	UK 2-48-350S	66,22/m	132	UN 5/38	12,64/bt.	138
UEBSMA 40S	32,83/pc.	129	UEKDS 35-R6 E	590,00/set	143	UKAZ 110-40S	18,27/pc.	136	UNE 260V-100S	82,26/pc.	145
UEBSMA 20S	31,64/pc.	129	UEKDS 35-V6 E	298,57/set	145	UKAZ 110-50S	18,98/pc.	136	UNE 260V-155S	92,30/pc.	145
UEBSMA 30S	32,24/pc.	129	UEKDS 45-V6 E	317,60/set	145	UKAZ 35-30S	11,06/pc.	136	UNE 260V-210S	111,64/pc.	145
UEBSMA 40S	32,83/pc.	129	UEP125-B	2,24/pc.	147	UKAZ 35-40S	11,06/pc.	136	UNE 260V-30S	78,09/pc.	145
UEBSMD-122R 20S	53,53/pc.	129	UEP125-KS 2	4,52/pc.	147	UKAZ 35-50S	11,73/pc.	136	UNE 260V-60S	79,77/pc.	145
UEBSMD-122R 30S	59,48/pc.	129	UEP125-UST 2	5,71/pc.	147	UKAZ 60-40S	11,60/pc.	136	USH 40	39,44/pc.	146
UEBSMD-122R 40S	65,43/pc.	129	UEP160-UST 2	5,71/pc.	147	UKAZ 60-50S	12,92/pc.	136	USK 120R-150	7,42/pc.	137
UEBSMD-185V 30S	59,48/pc.	129	UEP160-UST 2-TR	8,45/pc.	147	UKAZ 85-40S	17,85/pc.	136	USK 160V-150	10,29/pc.	137
UEBSMD-185V 40S	65,43/pc.	129	UET-R-WD	79,69/pc.	146	UKAZ 85-50S	17,85/pc.	136	USK 185V-150	12,25/pc.	137
UEBSMD-260R 40S	65,43/pc.	129	UET-R-WD E	215,30/pc.	146	UKBS 28-350S	501,97/pc.	133	USK 259V-150	15,29/pc.	137
UEBSMD-260V 40S	65,43/pc.	129	UET112-R-WD	88,73/pc.	146	UKBS 38-350S	523,39/pc.	133	USK 259V-225	23,74/pc.	137
UEBSMD-307R 40S	65,43/pc.	129	UETD-R-WD	78,81/pc.	146	UKBS 48-350S	547,18/pc.	133	USKH 259V-200	48,18/pc.	137
UEBSMSP 100	33,30/m	128	UETD-R-WD E	153,44/pc.	146	UKBSR 28-350S	20,64/pc.	133	USR 259-150	11,60/pc.	137
UEBSMSP 100S	21,41/m	128	UETD112-R-WD	84,57/pc.	146	UKBSR 38-350S	21,54/pc.	133	USR 308-150	12,61/pc.	137
UEBSMSP 60	20,22/m	128	UG	4,76/pc.	152	UKBSR 48-350S	22,60/pc.	133	USR 308-225	22,48/pc.	137
UEBSMSP 60S	17,25/m	128	UG-R	7,97/pc.	151	UKD 30S	23,32/m	135	USRH 308-200	41,75/pc.	137
UEBSMSW 100-20S	29,14/m	128	UG3	4,76/pc.	152	UKD 40S	26,78/m	135	UTG	1,42/pc.	152
UEBSMSW 100-30S	33,90/m	128	UG45-4	5,47/pc.	153	UKD 50S	32,30/m	135	UTG 75	1,61/pc.	151
UEBSMSW 100-40S	41,04/m	128	UG45FRWA-R2	46,65/pc.	156	UKDA-185V 30S	42,18/pc.	135	UVB 2-28-190S	52,57/pc.	132
UEBSMSW 120-20S	31,52/m	128	UG45FRWA-W2	44,63/pc.	156	UKDA-185V 40S	49,01/pc.	135	UVB 2-28-250S	56,93/pc.	132
UEBSMSW 120-30S	33,90/m	128	UG45FRWA-W2R2	74,11/pc.	156	UKDA-260R 30S	50,08/pc.	135	UVB 2-28-350S	63,88/pc.	132
UEBSMSW 120-40S	41,04/m	128	UG45FRWA-W4	65,38/pc.	156	UKDA-260R 40S	55,20/pc.	135	UVB 2-38-190S	53,60/pc.	132
UEBSMSW 60-20S	24,98/m	128	UG45FRWI-R2	46,65/pc.	156	UKDA-260R 50S	61,97/pc.	135	UVB 2-38-250S	57,52/pc.	132
UEBSMSW 60-30S	29,14/m	128	UG45FRWI-W2	44,63/pc.	156	UKDA-260V 40S	55,73/pc.	135	UVB 2-38-350S	64,53/pc.	132
UEBSMSW 60-40S	33,90/m	128	UG45FRWI-W2R2	74,11/pc.	156	UKDA-260V 50S	62,33/pc.	135	UVB 2-48-190S	56,09/pc.	132
UEBSMSW 80-20S	26,76/m	128	UG45FRWI-W4	65,38/pc.	156	UKDA-308R 40S	56,03/pc.	135	UVB 2-48-250S	60,31/pc.	132
UEBSMSW 80-30S	31,52/m	128	UGD 20-2	39,91/pc.	131	UKDA-308R 50S	62,64/pc.	135	UVB 2-48-350S	67,39/pc.	132
UEBSMSW 80-40S	36,88/m	128	UGE3-60K 4	60,98/pc.	160	UKE125 15-V E	261,69/pc.	146	UVB 3-28-250S	63,11/pc.	132
UEBSST 150S	17,85/pc.	128	UGE3-RE 8UST	41,64/pc.	160	UKE125 15-VP-WD	374,70/pc.	146	UVB 3-28-350S	75,42/pc.	132
UEBSST 80S	13,09/pc.	128	UGE3-RK 8UST	50,32/pc.	160	UKE125 25-V E	285,48/pc.	146	UVB 3-38-250S	67,80/pc.	132
UEK3-R 2	3,45/pc.	149	UGE3-VE 8UST	61,20/pc.	160	UKE125 25-V MS	440,12/pc.	146	UVB 3-38-350S	79,10/pc.	132
UEK3-R 5	3,45/pc.	149	UGE3-VK 8UST	47,11/pc.	160	UKE160 15-V E	285,48/pc.	147	UVB 3-48-250S	71,97/pc.	132
UEK3-R-G	64,94/pc.	139	UGE3-50-S	9,99/set	139	UKE160 15-VP-WD	392,54/pc.	147	UVB 3-48-350S	90,70/pc.	132
UEK3-R-S	64,94/pc.	139	UGE3-80-S	11,78/set	139	UKE160 25-V E	321,17/pc.	147	UWZ-IS 8	4,28/pc.	151
UEK3-V 2	2,14/pc.	149	UGEAR-50S	35,39/set	143	UKE160 25-V MS	481,75/pc.	147	XTB0304	8,87/pc.	174
UEK3-V 5	2,14/pc.	149	UGEAR-80S	37,23/set	143	UKEB 110-40S	13,44/pc.	136	XTB0308	15,25/pc.	174
UEK3-V-G	53,53/pc.	139	UGEAV-50S	9,99/set	145	UKEB 110-50S	14,99/pc.	136			
UEK3-V-S	53,53/pc.	139	UGEAV-80S	11,78/set	145	UKEB 35-30S	4,23/pc.	136			
UEKD 15-R E	412,76/set	142	UGEAV1-2 50S	9,99/set	148	UKEB 35-40S	4,76/pc.	136			
UEKD 15-RP E	570,97/set	142	UGEAV2-50S	9,99/set	143	UKEB 35-50S	6,30/pc.	136			
UEKD 15-V E	229,58/set	144	UGEE-1-DEP	6,30/pc.	160	UKEB 60-40S	7,13/pc.	136			
UEKD 15-VP E	334,25/set	144	UGEE-2-UST45	5,66/pc.	160	UKEB 60-50S	8,68/pc.	136			
UEKD 25-V E	242,66/set	144	UGEE3-2-UST45	6,65/pc.	160	UKEB 85-40S	9,87/pc.	136			
UEKD 35-R E	472,24/set	142	UGET-1-5PCOM 113	17,36/pc.	155	UKEB 85-50S	12,25/pc.	136			
UEKD 35-V E	260,50/set	144	UGET-1-5PK 113	17,36/pc.	155	UKL 3-28-250S	46,39/m	132			
UEKD 45-V E	279,54/set	144	UGET-1-RM 113	17,13/pc.	155	UKL 3-28-350S	63,45/m	132			
UEKD1-2 15-V E	196,27/pc.	148	UGET-1-UST45 113	20,05/pc.	155	UKL 3-38-250S	51,94/m	132			
UEKD1-2 25-V E	212,92/pc.	148	UGET-2-3PK 113	18,08/pc.	155	UKL 3-38-350S	65,43/m	132			
UEKD2 15-V E	255,75/pc.	143	UGET-2-AMP 113	17,13/pc.	154	UKL 3-48-250S	57,09/m	132			
UEKD2 25-V E	279,54/pc.	143	UGET-2-AMPSL 113	17,13/pc.	154	UKL 3-48-350S	67,40/m	132			
UEKD2-R 3	3,10/pc.	149	UGET-2-BTR 113	17,13/pc.	154	UKR 110-40S	58,28/m	135			
UEKD2-R-G	49,60/pc.	140	UGET-2-COR 113	17,36/pc.	154	UKR 110-50S	70,18/m	135			
UEKD2-R-S	49,60/pc.	140	UGET-2-GG45 113	17,13/pc.	154	UKR 35-30S	22,32/m	135			
UEKD2-V 3	1,78/pc.	149	UGET-2-KM 113	18,91/pc.	155	UKR 35-40S	25,43/m	135			
UEKD2-V-G	43,72/pc.	140	UGET-2-KR 113	17,13/pc.	155	UKR 35-50S	31,24/m	135			
UEKD2-V-S	43,72/pc.	140	UGET-2-LCDM 113	17,13/pc.	154	UKR 60-40S	37,23/m	135			
UEKD3-R 3	3,45/pc.	149	UGET-2-RMSC 113	17,13/pc.	155	UKR 60-50S	42,82/m	135			
UEKD3-R 5K	16,89/pc.	150	UGET-2-XLR 113	16,56/pc.	155	UKR 85-40S	53,93/m	135			
UEKD3-R-G	61,86/pc.	140	UGET-3-SCD 113	18,39/pc.	154	UKR 85-50S	59,48/m	135			
UEKD3-R-S	61,86/pc.	140	UGET-3-SCS 113	18,39/pc.	154	UKTR 110S	12,30/m	136			
UEKD3-V 3	2,14/pc.	149	UGETD-3 226	24,33/pc.	157	UKTR 35S	3,47/m	136			
UEKD3-V 5K	7,62/pc.	150	UGETD-UZ	11,84/pc.	157	UKTR 60S	10,23/m	136			
UEKD3-V-G	50,97/pc.	140	UGKB	29,03/pc.	138	UKTR 85S	10,01/m	136			
UEKD3-V-S	50,97/pc.	140	UGR1-4	38,90/set	148	UM 28-190S	11,06/pc.	133			
UEKDD 15-V E	336,63/pc.	141	UK 2-28-190S	41,64/m	132	UM 28-250S	11,73/pc.	133			
UEKDD 25-V E	356,85/pc.	141	UK 2-28-250S	45,20/m	132	UM 28-350S	13,03/pc.	133			
UEKDD1-2 15-V E	174,85/pc.	141	UK 2-28-350S	63,05/m	132	UM 38-190S	11,24/pc.	133			
UEKDD1-2 25-V E	189,13/pc.	141	UK 2-38-190S	43,61/m	132	UM 38-250S	11,96/pc.	133			



# Conditions générales de ventes

Toutes nos ventes sont conclues aux conditions suivantes, auxquelles il ne pourra être dérogé que par conventions expresses et écrites.

1. Nos offres sont faites sans engagement et sauf vente.
2. Tous les marchés sont considérés comme conclus à Deinze.
3. Sauf dispositions contraires expressément acceptées par nous, nos prix s'entendent toujours sans montage, ni pose, ni ajustage.
4. Les clauses figurant dans les correspondances et commandes de l'acheteur et qui dérogent aux présentes conditions ne peuvent être considérées comme acceptées par nous que si nous avons donné expressément notre accord écrit sur le contenu.
5. Les délais de livraison, de fournitures ou d'exécution ne constituent pas un engagement formel de notre part mais ne sont donnés qu'à titre indicatif; un retard de livraison de fournitures ou d'exécution ne peut donner lieu à dommages et intérêts que pour autant que pareille sanction ait été spécialement convenue et que nous l'ayons admise expressément et par écrit.  
Même dans cette éventualité, nous serions libérés par tous cas de force majeure, étant entendu que notamment les cas suivants sont conventionnellement à considérer comme tels: grèves, lock-out, panne de courant, d'eau, accident grave aux usines, machines, ateliers et magasins, troubles populaires, émeutes, mobilisations, guerre, gel, inondations, absence sur le marché de matières, etc. Cette énonciation est exemplative et non limitative. Le cas de force majeure ne peut entraîner la résiliation des marchés de la part de l'acheteur, ni le droit de se pourvoir ailleurs pour notre compte, pas plus que l'obligation pour nous de fournir en remplacement des produits d'une autre firme.
6. Les dessins que nous communiquons à nos clients, restent notre propriété et ne peuvent en aucun cas être transmis à

destiers, soit pour leur examen, soit pour leur copie.

Les gravures, photographies et dessins de nos catalogues ne sont donnés qu'à titre indicatif. Les perfectionnements constants que nous apportons à nos fabrications ne nous permettent pas de maintenir l'exécution suivant les cotes mentionnées sur nos plans et dessins. Dès lors les cotes indiquées ne nous engagent pas.

7. Nos marchandises voyagent aux risques et périls exclusifs du destinataire même si nous en assumons le transport. En cas d'avaries ou de manquants, l'acheteur devra adresser une réclamation au transporteur, ou la faire adresser par le destinataire, même si le prix de la marchandise avait été fixé pour livraison franco.  
Pour les fournitures «rendues sur chantier» nos camions ne devons pas quitter les chemins carrossables. Les frais résultant d'un stationnement ou déchargement supérieur au délai en usage seront à charge des clients.
8. Les marchandises sont toujours vendues «agrées avant expédition» même lorsque les prix comprennent le transport ou sont fixés à destination ou pose ou placement compris. L'acheteur à toujours le droit de les faire vérifier à ses frais avant l'enlèvement ou l'expédition. Notre acceptation de la commande constitue par elle-même une invitation expresse à venir faire la réception de la marchandise avant départ. L'acheteur est tenu de s'informer lui-même des dates de mise à disposition ou de départ ou d'expédition afin d'exercer en temps utile son droit de contrôle. Faute de l'exercer dans les dites conditions, la marchandise est considérée comme agréée. Par voie de conséquence toute réclamation ultérieure est non recevable.
9. Les réclamations au sujet du contenu ou du libellé des factures doivent se faire dans la huitaine de leur réception.
10. Les paiements doivent être effectués à Deinze. Nos conditions s'entendent nettes, paie-

ment vingt pour cent à la commande, le solde à la mise à disposition de la marchandise. Lorsque nos factures ne sont pas réglées à l'échéance prévue, nous nous réservons le droit, sans nouvel avertissement, de faire présenter des effets par nos banquiers, tous frais d'escompte, d'encaissement, etc., à charge de nos clients. Le jour d'enlèvement ou d'expédition de la marchandise sert de base à la fixation des échéances, même en cas de vente franco. Au cas où il aura été convenu que l'acheteur acceptera une ou plusieurs traites, le défaut de retour de celles-ci dans les quatre jours de l'envoi à l'acceptation, rendra leur montant total immédiatement exigible.

Les réclamations ne justifient pas le non-paiement.

L'existence d'une réclamation ou d'une contestation permet uniquement le paiement sous réserve. Le défaut de paiement à l'échéance entraînera de plein droit et sans mise en demeure préalable la majoration du montant de la facture de 15%, sans que cette majoration puisse être inférieure à 25 Euro.

Si des retards surviennent dans le paiement des acomptes prévus, nous nous réservons la faculté d'arrêter les travaux et d'annuler la commande, à notre choix, et sous toutes réserves de droit.

11. Nous nous réservons le droit, même après exécution partielle d'une marché, d'exiger de nos co-contractants une garantie de bonne exécution de leurs propres engagements. Le refus de satisfaire à pareille demande même amiable, nous fonderait à notre choix à surseoir à l'exécution du surplus ou à considérer le marché soit comme résolu, soit comme résilié aux torts et griefs du co-contractant et à tirer de cette résolution toutes conséquences de droit.
12. Nos prix sont établis sur base des conditions économiques, sociales et fiscales en vigueur au moment de notre offre. Toutes modifications à ces conditions, qui surviendraient après la date de notre offre, entraîneraient la révision de nos prix. Toute taxe mise ou venant à être mise sur la vente,

la fourniture, la fabrication ou le transport de nos marchandises est toujours à charge de l'acheteur.

13. Sous réserve expresse de nos droits à des dommages et intérêts, il nous est conventionnellement reconnu celui d'annuler les commandes et de considérer le marché comme-résilié même en cours d'exécution et sans sommation préalable - si après la conclusion du marché, l'acheteur néglige d'enlever la marchandise dans les délais fixés, de payer aux dates convenues, d'honorer une traite acceptée, d'exécuter chacune de ses obligations. Toute somme due à terme deviendra dans ce cas immédiatement exigible. Nous nous réservons le droit de résiliation du marché, également en cas de décès, faillite, suspension de paiement, protêt et dissolution de la société ou de la firme acheteuse.
14. Les offres faites ou les engagements pris par les agents et employés de notre firme ne nous lient effectivement qu'après ratification de notre part. Agents et commissionnaires ne sont pas qualifiés pour percevoir le montant des factures et nous ne reconnaissons comme pièce de décharge que celle qui porte notre signature.
15. Les tribunaux de Gand sont seuls compétents en cas de litige, même en cas d'appel en garantie ou de pluralité des défendeurs. La création de promesses ou traites, les acceptations de règlement, envois franco, n'opèrent ni vocation, ni dérogation à cette clause attributive de juridiction.
16. Sans préjudice des dispositions des articles 7 et 8 les marchandises restent la propriété du vendeur jusqu'au paiement intégral du prix.
17. Transport:
  - franc de port à partir de 500 Euro;
  - pour livraison à une autre adresse qu'adresse de livraison habituelle: prix départ usine.



**DUCTEL**<sup>®</sup>



**WIBE**



STAGOBEL ELECTRO est l'importateur exclusif de matériel électrique pour l'électro-installateur et l'industrie. Le vaste programme de produits de haute qualité comprend des systèmes de support de câbles économiques pour bâtiments industriels et tertiaires, le matériel de contact CEE, la protection contre la foudre, des stations de recharge pour e-mobility, des solutions innovatrices pour la gestion des bâtiments et la domotique.



Zone 1 - De Prijckels | Karrewegstraat 50 | B-9800 Deinze | T 09 381 85 00 | [info@stagobel.be](mailto:info@stagobel.be) | [www.stagobel.be](http://www.stagobel.be)



[www.facebook.com/StagobelElectro](https://www.facebook.com/StagobelElectro)



[www.linkedin.com/company/stagobel-electro](https://www.linkedin.com/company/stagobel-electro)



[www.youtube.com](https://www.youtube.com)