

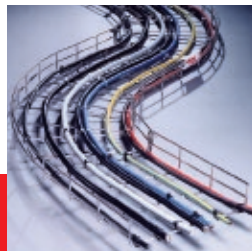

Liste des prix systèmes de support de câbles

Mars 2021



A propos de nous

Depuis 1977, Stagobel Electro est l'importateur exclusif pour le marché belge des matériaux d'installation électriques de fabricants renommés, belges et internationaux. Nous fournissons des produits et services, qui permettent à nos clients de consolider la sécurité, la fiabilité, la flexibilité, la durabilité et le confort des installations électriques dans l'industrie, les bureaux et les habitations.

Notre portfolio de produits se concentre sur cinq domaines: les systèmes de support de câbles pour l'industrie et les bureaux, le matériel de contact industriel CEE, la gestion des bâtiments, le matériel de sécurité électrique (distribution de courant, fusibles & la protection contre la foudre et les surtensions) et les stations de recharge pour l'e-mobility.

QUALITÉ

Nos partenaires-fabricants prônent des valeurs telles que l'innovation, la qualité, le design et la sécurité. Ils méritent toute votre confiance. Leurs produits, soigneusement conçus, répondent aux exigences du client. Nos fabricants innovent et investissent dans l'avenir afin de vous offrir le meilleur appui possible.

SUPPORT MATTERS!

Au fil des ans, la connaissance spécialisée de nos produits a été soigneusement édifée au sein de notre équipe de spécialistes bien formés et expérimentés. Nous aimons réfléchir avec vous. Vous pouvez compter sur notre support pour tout conseil durant la phase de conception, d'exécution ou de mise en service de votre projet. Rapide et professionnel. En ce qui concerne notre département de gestion des bâtiments, vous pouvez en outre compter sur un service professionnel après-vente.

COMPÉTENCE

Nous aimons partager notre connaissance et expérience. Suivez nos workshops, formations, séminaires, tous fréquemment organisés et bien fréquentés, et restez ainsi au courant de tous les nouveaux développements et tendances. Ainsi, vous pouvez conseiller vos clients en toute connaissance de cause.

PARTENARIAT

En tant que PME familiale, nous sommes persuadés que nos clients forment la base de notre entreprise. Un partenariat solide avec nos clients et nos fabricants constitue le fondement de notre organisation pour l'avenir. Que ce soit pour une question technique simple, une offre, une livraison ou la réception de travaux ... l'on peut toujours compter sur Stagobel Electro. Grâce à une étroite collaboration avec le réseau des électro-grossistes professionnels, nos produits sont aisément et rapidement disponibles dans toute la Belgique. Nous promettons uniquement ce que nous pouvons réaliser et nous considérons nos accords comme impératifs et contraignants.



Stock étendu, délai de livraison court.



Notre showroom.

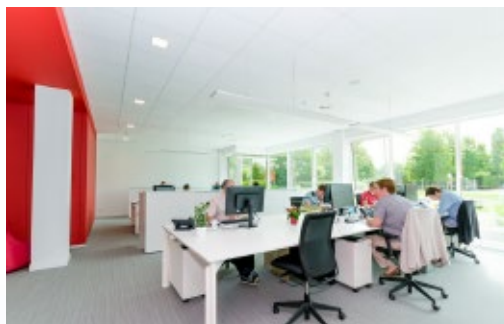

Notre équipe technique pour un soutien rapide et professionnel.



Notre connaissance reste à jour, grâce à nos formations.



Le site internet Stagobel STAGOBEL.BE

Notre **catalogue en ligne** vous donne un accès instantané à plus de **10 000 produits** avec les spécifications techniques nécessaires, les manuels d'assemblage, les vidéos disponibles, etc.



Dans votre **compte personnel MyStagobel**, vous trouverez vos produits préférés, les prix bruts, notre stock de produits, etc. Vous pouvez également rédiger des listes de matériaux et, le cas échéant, les envoyer à un collègue, votre personne de contact chez un grossiste...

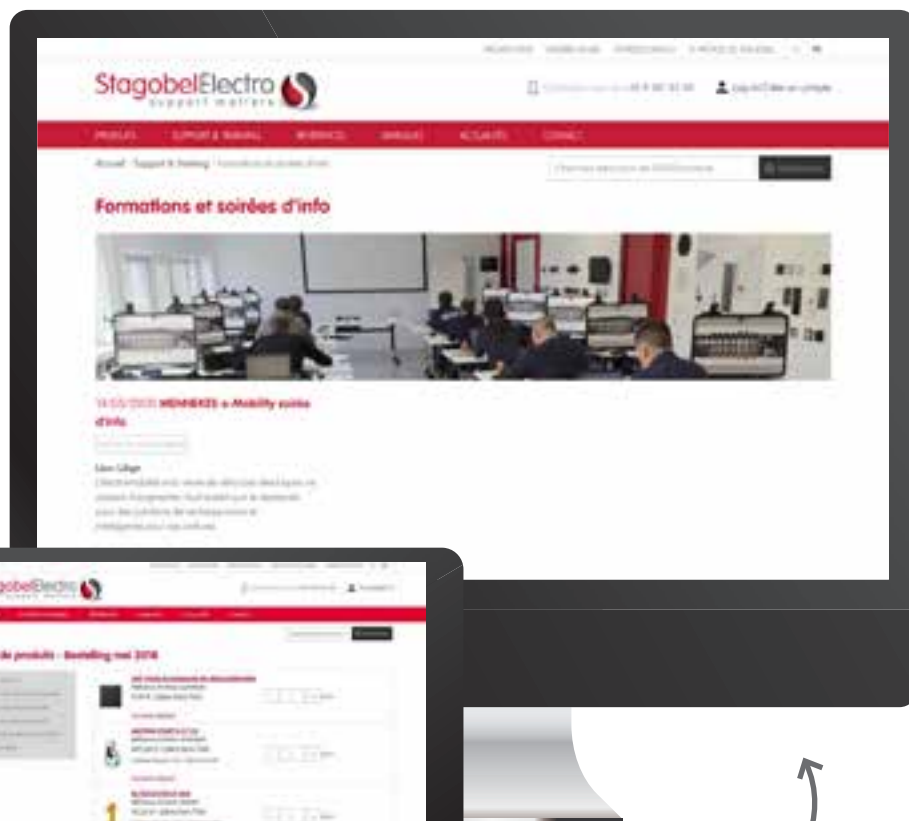

Sur le **campus Stagobel**, vous trouverez toutes les informations sur les formations et workshops prévus, tant dans nos bureaux à Deinze qu'à des endroits externes. Nous organisons également des webinars. Un enregistrement en ligne est possible.

Nous vous fournissons toutes les informations techniques, les mises à jour, les logiciels, ... 24h/24 et 7j/7

Dans la **bibliothèque Stagobel**, vous pouvez soit télécharger les documents souhaités, soit en demander une copie imprimée. Si vous envoyez cette demande via votre compte MyStagobel, toutes les informations nécessaires seront automatiquement remplies pour vous.

Dans notre **aperçu déroulant de solutions**, vous trouvez la solution appropriée pour chaque question ou application spécifique. Découvrez vite notre portfolio étendu de solutions intégrées, fondées sur nos gammes de produits qualitatives, efficaces et économiques.

Nouveau dans l'assortiment

inducanal[®]

gaines à câbles fermées
fond complètement plat

PAGE 59 & 60



pemsa[®]**band**

chemins de câbles perforés
double rangée de perforations
latérales

PAGE 59 & 60



**Conduits, raccords
et presse-étoupes**

PAGE 135



**Gaines murales
DUCTEL**

Egalement disponibles en
aluminium noir laqué

PAGE 195

**Gaines à
câbles STAGO**

Egalement disponibles dans les
finitions laqué noir et laqué blanc

PAGE 39



rejiband® RAPIDE

PAGE 90 & 94

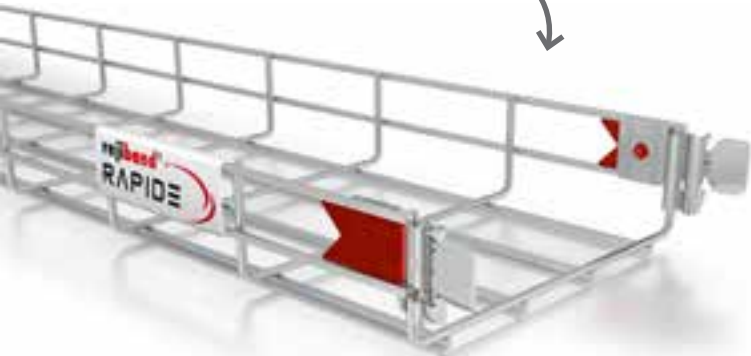

Seulement
en 2 clicks

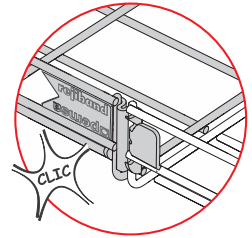
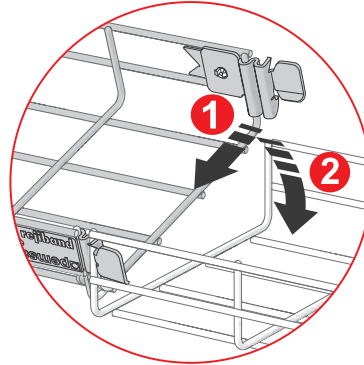

Le système le
plus rapide

rejiband® 60x60-2

avec double fil

PAGE 92



Installation
facile



Charge
élevée



Possibilités
pour fixer

rejiband® BLACK C8®

PAGE 111

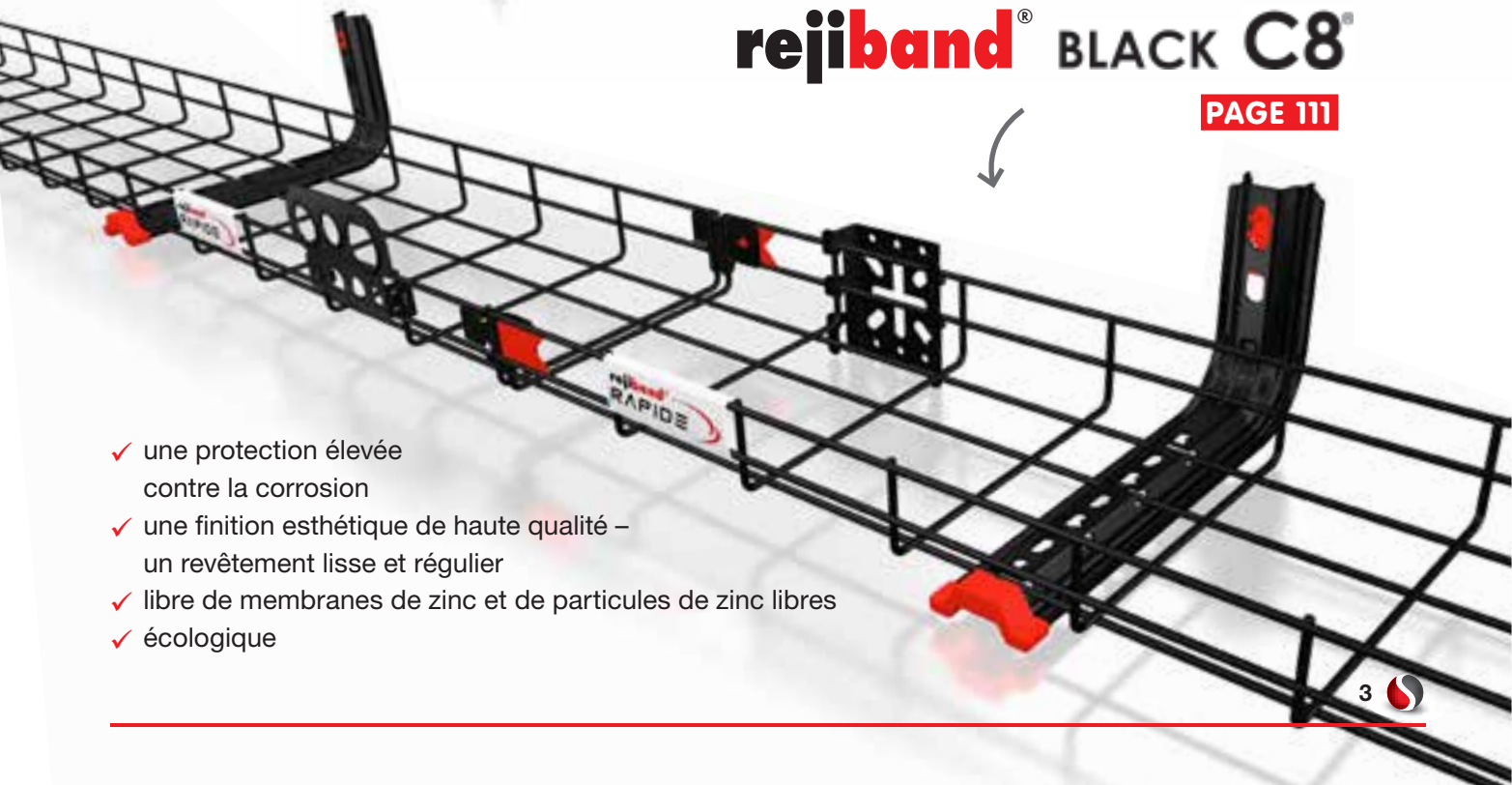

- ✓ une protection élevée contre la corrosion
- ✓ une finition esthétique de haute qualité – un revêtement lisse et régulier
- ✓ libre de membranes de zinc et de particules de zinc libres
- ✓ écologique

Légende

Général

	Tous les prix bruts sont en euro, hors TVA. Les prix des articles vendus par longueurs s'entendent au mètre. Les prix des accessoires s'entendent par pièce, par set ou par boîte.
	Nouveau dans l'assortiment.
10 pc.	Cet article est uniquement livré en emballage standard.
2 m	Cette longueur est uniquement livrée en longueur standard.
30 m	Pour faciliter le transport, il est recommandé de commander cet article dans la quantité indiquée.
	✓ signifie disponible de stock. Pour l'état de stock actuel, veuillez bien consulter notre site Web. Si temporairement pas en stock, nous vous garantissons un délai de livraison rapide.

Applications

	Industrie
	Tertiaire
	Tunnels
	Centres de données
	Installations PV
	Industrie alimentaire
	Pétrochimie

Caractéristiques

	Info supplémentaire
(mm)	Largeur (mm)
(mm)	Hauteur (mm)
L mm	Longueur (mm)
N/m	Charge légère
N/m	Charge moyenne
N/m	Charge élevée
	Maintien de fonction E60/E90
	Température de travail
	Comportement radiation ultra violette
Flex	Flexibilité
	Exempt d'halogènes
	Pas d'accélérateur de feu
	Classification IP
	Codification selon la norme internationale de conduits code IEC 61386

Traitement de surface

Traitement de surface		Recommandé dans les environnements corrosifs mentionnés ci-après selon NBN- EN ISO 12944-2
E.Z.	Zingage électrolytique NBN EN ISO 2081	C1 (très faible)
G.S.	Galvanisation Sendzimir NBN EN 10346	C2 (faible)
Z.B.	Zingage électrolytique, bichromaté NBN EN ISO 2081	C2 (faible)
H.D.	Galvanisation à chaud NBN EN ISO 1461	C3/C4 (moyen/haute)
Black C8	Black C8, Protection Haute Résistance, Class 8 IEC 61537	C5-I (très élevé – industrie)
Zinkpox blanc	Galvanisation à chaud + epoxy coating	C5-I (très élevé – industrie)
INOX 304	Acier inoxydable AISI 304	C5-I (très élevé – industrie)
INOX 316L	Acier inoxydable AISI 316L	C5-M (très élevé – maritime)

Les environnements corrosifs selon NBN EN ISO 12944-2

	C1 Bâtiments chauffés à faible exposition à la corrosion, comme p. ex. les hôtels et les bureaux.		C4 Environnements industriels et zones côtières à taux de salinité moyen et présentant un taux élevé de corrosion environnementale, d'humidité de l'air et de pollution de l'air, comme p.ex. les entreprises chimiques, les zones portuaires et les piscines.
	C2 Bâtiments non chauffés dans des atmosphères à faible taux de pollution (généralement dans des zones rurales), comme p.ex. les entrepôts et les parkings souterrains.		C5-I Environnements présentant un taux élevé d'humidité de l'air et de pollution de l'air presque constant, comme p.ex. les industries chimiques et lourdes, les tunnels et les zones portuaires.
	C3 Villes et environnements de l'industrie légère à corrosion environnementale moyenne, comme p.ex. les blanchisseries, les brasseries et l'industrie alimentaire.		C5-M Environnements présentant un taux élevé d'humidité de l'air, de pollution de l'air et de salinité presque constant, comme p.ex. les zones côtières et offshore.

Contenu

	page
Echelles à câbles WIBE	7
Gaines à câbles et chemins de câbles STAGO	39
Chemins de câbles et gaines à câbles PEMSA	59
Treillis à câbles PEMSA	91
Système de suspension avec câble SPIDERBAND	121
Profilés STAGOBEL et accessoires	125
Conduits métalliques, raccords et presse-étoupes	135
Systèmes de support de câbles avec maintien de fonction	143
Systèmes de gaines de sol PUK	157
Gaines murales en aluminium et en matière synthétique DUCTEL	195
Canalisations à câbles en matière synthétique KOPOS	211
Colonnes de distribution et de bureau en aluminium IDT	239
Connexions bureautiques IBCONNECT	245
Index	264
Conditions de vente générales	280

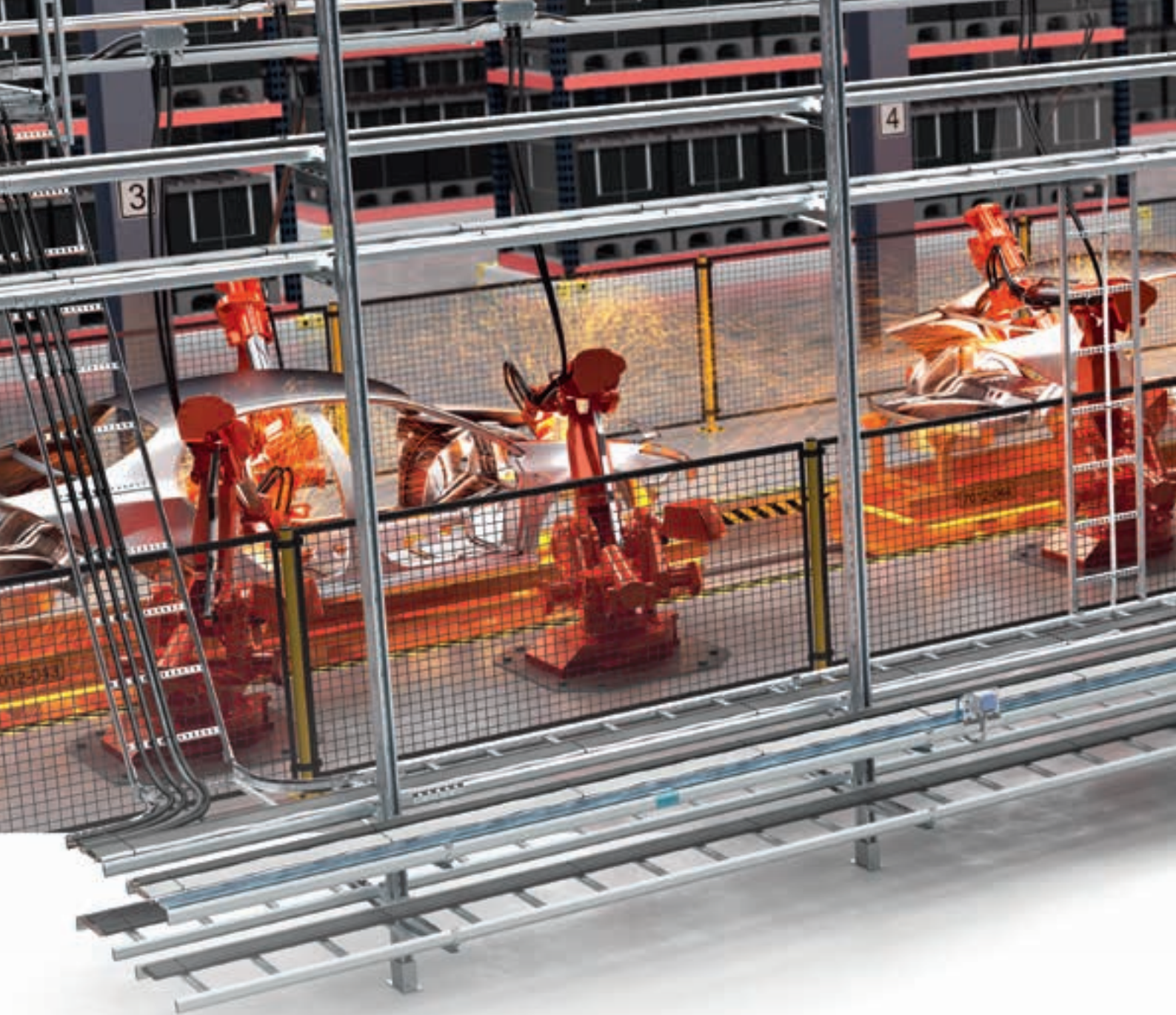





Échelles à câbles







La colonne vertébrale d'une structure exceptionnelle

Les systèmes de support de câbles sont essentiels à l'infrastructure d'un bâtiment, de la même manière que l'est la colonne vertébrale pour notre corps. Les échelles à câbles WIBE sont solides et fonctionnelles et peuvent être montées à l'horizontale ou à la verticale. Fort d'une vaste gamme d'accessoires et d'une grande variété de traitements de surface, le système d'échelles à câbles WIBE constitue une gamme sûre, flexible et facile d'entretien, pouvant être montée dans toutes les directions et dans tous les angles.











Aperçu

KHZSP KHZSPZ	KHZPS KHZP	KHZ	KHZPV	KHZV
Profilé ouvert échelon perforé	Profilé fermé échelon perforé	Profilé fermé échelon rond	Profilé fermé renforcé échelon perforé	Profilé fermé renforcé échelon rond
				

Caractéristiques

G.S.	✓	✓			
H.D.	✓	✓	✓	✓	✓
ZINKPOX blanc		✓	✓	✓	✓
INOX 316L		✓	✓	✓	
 mm	200-600	150-1000	150-600	200-1000	200-600
 mm	55	55	55	150	150
L mm	3000-4000-6000	6000	6000	6000	6000
 N/m					
		E60			

Applications

 Industrie		✓	✓	✓	✓
 Tertiaire	✓				
 Tunnels	✓	✓	✓	✓	✓
 Centres de données	✓	✓	✓		
 Installations PV	✓	✓	✓		
 Industrie alimentaire			✓		✓
 Pétrochimie/pharma		✓	✓	✓	✓
 G.S.	page 8	page 8	-	-	-
 H.D.	page 8	page 8	page 9	page 9	page 9
 Zinkpox blanc	-	page 8	page 9	page 9	page 9
 INOX 316L	-	page 8	page 9	page 9	-

G.S.

Galvanisé Sendzimir NBN EN10346 – recommandé dans les environnements corrosifs C2 (faible)

H.D.

Galvanisé à chaud NBN EN ISO 1461 – recommandé dans les environnements corrosifs C3/C4 (moyen/haut)

Zinkpox blanc

Galvanisé à chaud + epoxy coating – recommandé dans les environnements corrosifs C5-I (très élevé/industrie)

INOX 316L

Acier inoxydable AISI316L – recommandé dans les environnements corrosifs C5-M (très élevé/maritime)

 voir page 4

Echelles à câbles

	type	référence	 stock	page. catal.	groupe d'articles	prix en €		
	Echelle à câbles KHZSP							
	Acier galvanisé Sendzimir	200	783155	✓	21	10303	21,47/m	
	↔ 3 m		300	783156	✓	21	10303	26,46/m
			400	783157	✓	21	10303	30,10/m
			500	783158	✓	21	10303	35,02/m
			600	783159	✓	21	10303	38,60/m
Echelle à câbles KHZSP								
Acier galvanisé Sendzimir	200	718572	✓	21	10303	21,47/m		
↔ 4 m		300	718573	✓	21	10303	26,46/m	
		400	718574	✓	21	10303	30,10/m	
		500	718575		21	10303	35,02/m	
		600	718576		21	10303	38,60/m	
	Echelle à câbles KHZSP							
Acier galvanisé Sendzimir	200	734488	✓	21	10303	21,47/m		
↔ 6 m		300	734489	✓	21	10303	26,46/m	
		400	734490	✓	21	10303	30,10/m	
		500	734491		21	10303	35,02/m	
		600	734492		21	10303	38,60/m	
		Echelle à câbles KHZSPZ						
Acier galvanisé à chaud		200	734494	✓	22	10301	40,00/m	
↔ 6 m			300	734495	✓	22	10301	41,79/m
			400	734496	✓	22	10301	44,74/m
			500	734497		22	10301	48,56/m
			600	734498	✓	22	10301	51,25/m
	Echelle à câbles KHZPS							
Acier galvanisé Sendzimir	150	725350	✓	23	10308	41,87/m		
↔ 6 m		200	725351	✓	23	10308	41,87/m	
		300	725352	✓	23	10308	43,30/m	
		400	725353	✓	23	10308	45,11/m	
		500	725354	✓	23	10308	47,47/m	
		600	725355	✓	23	10308	49,97/m	
		800	781099		23	10308	76,31/m	
		1000	725356		23	10308	117,54/m	
		Echelle à câbles KHZP						
Acier galvanisé à chaud		150	718562	✓	25	10312	48,42/m	
↔ 6 m			200	718563	✓	25	10312	48,42/m
			300	718564	✓	25	10312	50,46/m
			400	718565	✓	25	10312	52,69/m
			500	718566	✓	25	10312	56,57/m
			600	718567	✓	25	10312	58,92/m
			800	721960	✓	25	10312	107,48/m
		1000	718568	✓	25	10312	179,97/m	
	Echelle à câbles KHZP							
	Zinkpox blanc	150	718591		25	10302	77,45/m	
	↔ 6 m		200	718592		25	10302	77,45/m
			300	718593		25	10302	80,76/m
			400	718594		25	10302	84,32/m
			500	718595		25	10302	90,54/m
			600	718596		25	10302	94,60/m
			800	728033		25	10302	171,95/m
		1000	718597		25	10302	287,93/m	











Echelles à câbles

	type	référence	stock	page. catal.	groupe d'articles	prix en €
	Echelle à câbles KHZP					
	Acier inoxydable AISI 316L	150	727382	✓	25	10305 208,24/m
	↔ 6 m	200	727383	✓	25	10305 211,15/m
		300	727384	✓	25	10305 216,98/m
		400	727385	✓	25	10305 228,61/m
		500	727386	✓	25	10305 238,31/m
		600	727387	✓	25	10305 249,95/m
800		782128		25	10305 495,33/m	
1000	782129		25	10305 568,29/m		
	Echelle à câbles KHZ					
	Acier galvanisé à chaud	150	768001	✓	24	10301 60,01/m
	↔ 6 m	200	768002	✓	24	10301 60,01/m
		300	768004	✓	24	10301 62,31/m
		400	768005	✓	24	10301 65,18/m
		500	768006	✓	24	10301 69,96/m
600		768007	✓	24	10301 72,99/m	
	Echelle à câbles KHZ					
	Zinkpox blanc	150	714058		24	10302 96,03/m
	↔ 6 m	200	714059		24	10302 96,03/m
		300	714061		24	10302 99,69/m
		400	714062		24	10302 104,31/m
		500	714063		24	10302 111,94/m
600		714064		24	10302 116,80/m	
	Echelle à câbles KHZ					
	Acier inoxydable AISI 316L	150	727376		24	10305 344,75/m
	↔ 6 m	200	727377		24	10305 350,06/m
		300	727378		24	10305 366,50/m
		400	727379		24	10305 370,24/m
		500	727380		24	10305 377,47/m
600		727381		24	10305 384,76/m	
	Echelle à câbles KHZV					
	Acier galvanisé à chaud	200	712015	✓	26	10301 116,28/m
	↔ 6 m	300	712017	✓	26	10301 119,34/m
		400	712019	✓	26	10301 121,93/m
		500	712018	✓	26	10301 126,43/m
		600	712020	✓	26	10301 127,87/m
		Echelle à câbles KHZV				
	Zinkpox blanc	200	714198		26	10302 213,65/m
	↔ 6 m	300	714200		26	10302 218,53/m
		400	714202		26	10302 223,41/m
		500	714201		26	10302 232,85/m
		600	714203		26	10302 234,23/m
		Echelle à câbles KHZPV				
	Acier galvanisé à chaud	200	717982	✓	27	10301 116,28/m
	↔ 6 m	300	717983	✓	27	10301 119,34/m
		400	717984	✓	27	10301 121,93/m
		500	717985	✓	27	10301 126,43/m
		600	717986	✓	27	10301 127,87/m
1000		716400		27	10301 300,32/m	
	Echelle à câbles KHZPV					
	Zinkpox blanc	200	723390		27	10302 198,52/m
	↔ 6 m	300	723391		27	10302 203,17/m
		400	723392		27	10302 207,16/m
		500	723393		27	10302 215,49/m
		600	723394		27	10302 215,94/m
1000		716401		27	10302 401,71/m	











Echelles à câbles

	type	référence	 stock	page. catal.	groupe d'articles	prix en €	
	Echelle à câbles KHZPV						
	Acier inoxydable AISI 316L	200	784066		27	10305	444,76/m
	←→ 6 m	300	784067		27	10305	463,05/m
		400	784068		27	10305	487,94/m
		500	784069		27	10305	507,41/m
		600	784070		27	10305	523,38/m
1000		784072		27	10305	960,68/m	
	Console 50i						
	Acier galvanisé Sendzimir	50i/ 100	791412	✓	30	10304	4,50/pc.
		50i/ 200	791413	✓	30	10304	6,27/pc.
		50i/ 300	791414	✓	30	10304	7,61/pc.
		50i/ 400	791415	✓	30	10304	12,32/pc.
		50i/ 500	795322	✓	-	10304	19,16/pc.
	Console 50i						
	Acier galvanisé à chaud	50i/ 100	795316	✓	-	10304	8,17/pc.
		50i/ 200	795317	✓	-	10304	9,23/pc.
		50i/ 300	795318	✓	-	10304	13,51/pc.
		50i/ 400	795319	✓	-	10304	15,34/pc.
		50i/ 500	795320	✓	-	10304	20,90/pc.
	Console 30						
	Acier galvanisé Sendzimir	30/ 200	727777		31	10313	39,96/pc.
		30/ 300	727778		31	10313	43,64/pc.
	Seulement pour échelles à câbles KHZSP.	30/ 400	727779		31	10313	48,66/pc.
		30/ 500	727780		31	10313	54,03/pc.
		30/ 600	727781		31	10313	55,55/pc.
	Console 50						
	Acier galvanisé à chaud	50/ 100	723432	✓	32	10304	14,41/pc.
		50/ 150	723433	✓	32	10304	14,57/pc.
		50/ 200	723434	✓	32	10304	14,94/pc.
		50/ 250	723435	✓	32	10304	16,88/pc.
		50/ 300	723436	✓	32	10304	17,20/pc.
		50/ 400	723437	✓	32	10304	27,19/pc.
		50/ 500	723438	✓	32	10304	35,95/pc.
		50/ 600	723439	✓	32	10304	37,75/pc.
		50/ 700	727125	✓	32	10304	73,67/pc.
		50/ 800	727126	✓	32	10304	77,64/pc.
		50/ 900	727127	✓	32	10304	85,55/pc.
		50/ 1000	727128	✓	32	10304	91,75/pc.
	Console 50						
	Zinkpox blanc	50/ 100	723440		32	10302	44,68/pc.
		50/ 150	723441		32	10302	44,68/pc.
		50/ 200	723442		32	10302	45,42/pc.
		50/ 250	723443		32	10302	53,31/pc.
		50/ 300	723444		32	10302	54,83/pc.
		50/ 400	723445		32	10302	72,24/pc.
		50/ 500	723446		32	10302	93,46/pc.
		50/ 600	723447		32	10302	97,55/pc.
		50/ 700	727782		32	10302	151,65/pc.
		50/ 800	727783		32	10302	171,70/pc.
	50/ 900	727784		32	10302	175,69/pc.	
	50/ 1000	727785		32	10302	177,55/pc.	

Echelles à câbles

	type	référence	stock	page. catal.	groupe d'articles	prix en €
	Console 50					
	Acier inoxydable AISI 316L	50/ 100	725618		32	10305 95,99/pc.
		50/ 150	725619	✓	32	10305 97,47/pc.
		50/ 200	725620	✓	32	10305 100,49/pc.
		50/ 250	725621	✓	32	10305 117,11/pc.
		50/ 300	725622	✓	32	10305 199,78/pc.
		50/ 400	725623	✓	32	10305 250,87/pc.
		50/ 500	725624	✓	32	10305 272,50/pc.
	50/ 600	725625	✓	32	10305 298,79/pc.	
	Console 50F					
	Acier galvanisé à chaud	50F/ 200	718624	✓	32	10313 52,24/pc.
		50F/ 300	718625	✓	32	10313 56,55/pc.
		50F/ 400	718626	✓	32	10313 64,99/pc.
		50F/ 500	718627	✓	32	10313 73,60/pc.
		50F/ 600	718628	✓	32	10313 82,14/pc.
		50F/ 1000	712465	✓	32	10313 213,24/pc.
	Console 50F					
	Zinkpox blanc	50F/ 200	714021		32	10302 64,78/pc.
		50F/ 300	714700		32	10302 73,06/pc.
		50F/ 400	714022		32	10302 82,64/pc.
		50F/ 500	718793		32	10302 100,55/pc.
		50F/ 600	714023		32	10302 107,39/pc.
	50F/ 1000	714024		32	10302 247,42/pc.	
   	Etrier 42					
	Acier galvanisé Sendzimir	42	795240	✓	-	10313 4,11/pc.
	 10 pc.					
	Etrier 42					
	Zinc+	42	795241	✓	-	10313 5,70/pc.
	Acier galvanisé à chaud	42	795242	✓	-	10313 6,50/pc.
	 10 pc.					
	Etrier 42					
	Zinkpox blanc	42	795243	✓	-	10302 14,52/pc.
	 10 pc.					
Etrier 42						
Acier inoxydable AISI 316L	42	725763	✓	34	10305 10,96/pc.	
 10 pc.						











Echelles à câbles

	type	référence	 stock	page. catal.	groupe d'articles	prix en €	
  	Etrier 43						
	Acier galvanisé à chaud	43	707511	✓	34	10313	9,97/pc.
	 10 pc.						
Etrier 43							
Zinkpox blanc	43	714165		34	10302	12,90/pc.	
 10 pc.							
Etrier 43							
Acier inoxydable AISI 316L	43	792893	✓	-	10305	15,84/pc.	
 10 pc.							
 	Plaque de fond 40						
	Acier galvanisé à chaud	40	768738		35	10313	19,28/pc.
Plaque de fond 40							
Zinkpox blanc	40	714029		35	10302	28,93/pc.	
 	Profilé de suspension 40						
	Acier galvanisé à chaud	40	717001		35	10313	25,31/pc.
	L = 270 mm						
Profilé de suspension 40							
Zinkpox blanc	40	729045		35	10302	67,10/pc.	
L = 270 mm							
	Fixation tige/ console 82						
	Acier galvanisé à chaud	82	786768		36	10313	68,77/pc.

Echelles à câbles

	type	référence	stock	page. catal.	groupe d'articles	prix en €	
	Support console 3						
	Acier galvanisé Sendzimir	3/ 200	721869		38	10313	13,41/pc.
		3/ 300	721870		38	10313	18,28/pc.
		3/ 400	721871	✓	38	10313	19,58/pc.
		3/ 500	721872	✓	38	10313	25,96/pc.
	3/ 600	721873	✓	38	10313	28,42/pc.	
	Support console 3						
	Acier galvanisé à chaud	3/ 150	720761		38	10313	17,97/pc.
		3/ 200	720762		38	10313	18,75/pc.
		3/ 300	720763		38	10313	20,53/pc.
		3/ 400	720764		38	10313	23,72/pc.
	3/ 500	720765		38	10313	31,66/pc.	
	3/ 600	720766		38	10313	36,49/pc.	
	Support console 3						
	Zinkpox blanc	3/ 150	721862		38	10302	45,11/pc.
		3/ 200	721863		38	10302	45,61/pc.
		3/ 300	721864		38	10302	51,54/pc.
		3/ 400	721865		38	10302	53,38/pc.
	3/ 500	721866		38	10302	58,91/pc.	
	3/ 600	721867		38	10302	61,60/pc.	
	Support console 3						
	Acier inoxydable AISI 316L	3/ 150	726433		38	10305	99,55/pc.
		3/ 200	726434		38	10305	102,24/pc.
		3/ 300	726435		38	10305	152,71/pc.
		3/ 400	726436		38	10305	207,31/pc.
	3/ 500	726437		38	10305	322,81/pc.	
	3/ 600	726438		38	10305	349,26/pc.	
	Support console HSO						
	Acier galvanisé à chaud	150/M10	791063	✓	40	10313	20,77/pc.
		200/M10	791064	✓	40	10313	21,23/pc.
		300/M10	791065	✓	40	10313	21,68/pc.
		400/M16	791066		40	10313	22,39/pc.
		500/M16	791067		40	10313	23,23/pc.
	600/M16	791068		40	10313	23,66/pc.	
	Plaque de fond HSO M16						
Acier galvanisé à chaud	M16	791092		40	10313	4,10/pc.	
📦 10 pc.							
	Support console 6						
	Acier galvanisé Sendzimir	6/ 200	727582		41	10313	14,73/pc.
		6/ 300	727583		41	10313	17,09/pc.
	Seulement pour échelles à câbles KHZSP.	6/ 400	727584		41	10313	20,19/pc.
		6/ 500	727585		41	10313	25,25/pc.
	6/ 600	727586		41	10313	28,44/pc.	
	Tige filetée M10						
	Acier à zingage électrolytique	2000	716792		42	10313	4,93/m
	↔ 2 m ↔ 3 m	3000	716793		42	10313	4,93/m
	Tige filetée M10						
	Acier inoxydable AISI 316	2000	723925		42	10305	71,72/m
	↔ 2 m ↔ 3 m	3000	723926		42	10305	77,48/m







Echelles à câbles

	type	référence	 stock	page. catal.	groupe d'articles	prix en €	
	Ecrou de rallonge hexagonal						
	Acier à zingage électrolytique	M10	724806	✓	42	10313	5,12/pc.
	Acier inoxydable AISI 316	M10	724807		42	10305	39,97/pc.
	 10 pc.						
	Ecrou hexagonal						
	Acier galvanisé à chaud	M10	723938		42	10313	0,64/pc.
	Acier inoxydable AISI 316	M10	723939		42	10305	2,62/pc.
	 100 pc.						
	Pendard simple 2						
	Acier galvanisé à chaud	2/ 300	717191	✓	44	10313	16,39/pc.
		2/ 400	717192	✓	44	10313	18,33/pc.
		2/ 500	717193	✓	44	10313	19,27/pc.
		2/ 700	717194	✓	44	10313	26,92/pc.
		2/ 1000	717195	✓	44	10313	31,66/pc.
	Pendard simple 2						
	Zinkpox blanc	2/ 300	716283		44	10302	65,16/pc.
		2/ 400	716284		44	10302	68,38/pc.
		2/ 500	716285		44	10302	74,58/pc.
		2/ 700	716286		44	10302	81,33/pc.
		2/ 1000	716287		44	10302	93,46/pc.
	Pendard simple 2						
	Acier inoxydable AISI 316L	2/ 300	725557		44	10305	71,43/pc.
		2/ 400	725558		44	10305	79,24/pc.
		2/ 500	725559		44	10305	103,63/pc.
		2/ 700	725560		44	10305	111,06/pc.
		2/ 1000	725561		44	10305	135,42/pc.
	Pendard simple 2F						
	Acier galvanisé à chaud	2F/ 280	717196	✓	46	10313	22,79/pc.
		2F/ 370	717197	✓	46	10313	26,04/pc.
		2F/ 505	717198	✓	46	10313	29,56/pc.
		2F/ 640	794202		-	10313	30,61/pc.
		2F/ 730	717199	✓	46	10313	33,93/pc.
		2F/ 1000	717200	✓	46	10313	38,97/pc.
		2F/ 1500	787276	✓	46	10313	113,17/pc.
	Pendard simple 2F						
	Zinkpox blanc	2F/ 280	717201		46	10302	68,62/pc.
		2F/ 370	717202		46	10302	74,43/pc.
		2F/ 505	717203		46	10302	84,53/pc.
		2F/ 730	717204		46	10302	100,93/pc.
		2F/ 1000	717205		46	10302	112,33/pc.
		2F/ 1500	787277		46	10302	169,36/pc.
		Pendard simple 2F					
Acier inoxydable AISI 316L		2F/ 280	725562		46	10305	109,76/pc.
		2F/ 370	725563	✓	46	10305	127,99/pc.
		2F/ 505	725564	✓	46	10305	162,07/pc.
		2F/ 730	725565	✓	46	10305	213,76/pc.
		2F/ 1000	725566	✓	46	10305	276,35/pc.
	2F/ 1500	787278		46	10305	482,54/pc.	

Echelles à câbles

	type	référence	stock	page. catal.	groupe d'articles	prix en €	
	Pendant double 20						
	Acier galvanisé à chaud	20/ 505	715723	✓	48	10313	70,78/pc.
		20/ 730	715724	✓	48	10313	86,09/pc.
		20/ 1000	715725	✓	48	10313	109,04/pc.
		20/ 1500	715726	✓	48	10313	142,33/pc.
		20/ 2000	715727	✓	48	10313	178,83/pc.
		20/ 3000	715728	✓	48	10313	296,12/pc.
	Zinkpox blanc	20/ 505	716276		48	10302	115,59/pc.
		20/ 730	716277		48	10302	139,36/pc.
		20/ 1000	716278		48	10302	170,26/pc.
20/ 1500		716279		48	10302	234,28/pc.	
20/ 2000		716280		48	10302	327,88/pc.	
20/ 3000		716281		48	10302	526,80/pc.	
Acier inoxydable AISI 316L	Pendant double 20						
	20/ 505	725567	✓	48	10305	445,15/pc.	
	20/ 730	725568	✓	48	10305	549,03/pc.	
	20/ 1000	725569	✓	48	10305	661,00/pc.	
	20/ 1500	725570		48	10305	861,31/pc.	
	20/ 2000	725571		48	10305	1071,08/pc.	
Acier galvanisé à chaud	Pendant double 20F						
	20F/ 1000	718249		50	10313	137,33/pc.	
	20F/ 1500	718250		50	10313	185,72/pc.	
	20F/ 2000	718251		50	10313	230,06/pc.	
Zinkpox blanc	Pendant double 20F						
	20F/ 1000	718484		50	10302	222,67/pc.	
	20F/ 1500	718485		50	10302	293,79/pc.	
	20F/ 2000	718486		50	10302	426,31/pc.	
Acier galvanisé à chaud	Pendant double 20FS						
	20FS/ 1500	718718		52	10313	352,87/pc.	
	20FS/ 2000	718719		52	10313	421,89/pc.	
	20FS/ 2500	718720		52	10313	557,21/pc.	
Zinkpox blanc	Pendant double 20FS						
	20FS/ 1000	720521		52	10302	688,63/pc.	
	20FS/ 1500	720522		52	10302	819,64/pc.	
	20FS/ 2000	720523		52	10302	1016,39/pc.	
Acier galvanisé Sendzimir	Profilé de suspension 24/34						
	3000	721102	✓	54	10313	12,03/m	
	←→ 3 m						
	Profilé de suspension 24/34						
	300	725357		54	10313	7,17/pc.	
10 pc.	400	725358		54	10313	8,12/pc.	
	500	725359		54	10313	9,59/pc.	
	700	725360		54	10313	12,46/pc.	
	1000	725361		54	10313	16,26/pc.	















Echelles à câbles

	type	référence	 stock	page. catal.	groupe d'articles	prix en €
	Profilé de suspension 24/34					
	Acier galvanisé à chaud	3000	715879		54 10313	20,67/m
	↔ 3 m					
	Profilé de suspension 24/34					
	Zinkpox blanc	3000	716309		54 10302	34,39/m
	↔ 3 m					
	Profilé de suspension 24/34					
	Acier inoxydable AISI 316L	3000	725579		54 10305	70,63/m
↔ 3 m						
	Profilé de suspension 24/34					
	Acier inoxydable AISI 316L	300	725574		54 10305	21,20/pc.
	 10 pc.	400	725575		54 10305	28,26/pc.
		500	725576		54 10305	35,33/pc.
		700	725577		54 10305	50,39/pc.
		1000	725578		54 10305	70,63/pc.
		Profilé de suspension 24/48				
Acier galvanisé Sendzimir	3000	731717	✓	55 10313	26,80/m	
↔ 3 m ↔ 6 m	6000	731721	✓	55 10313	26,80/m	
	Profilé de suspension 24/48					
	Acier galvanisé à chaud	3000	705093	✓	55 10313	31,54/m
	↔ 3 m ↔ 6 m	6000	731719	✓	55 10313	31,54/m
	Profilé de suspension 24/48					
Zinkpox blanc	3000	716306		55 10302	49,48/m	
↔ 3 m ↔ 6 m	6000	731724		55 10302	49,57/m	
Profilé de suspension 24/48						
Acier inoxydable AISI 316L	3000	728595		55 10305	202,34/m	
↔ 3 m ↔ 6 m	6000	731727		55 10305	202,34/m	
Rail à encastrer 24/26 x 53						
Acier galvanisé à chaud	4000	768063		56 10313	43,44/m	
↔ 4 m						
Profilé de suspension 24/20						
Acier galvanisé à chaud	3000	709795	✓	57 10313	92,43/m	
↔ 3 m						
Profilé de suspension 24/20						
Zinkpox blanc	3000	716307		57 10302	131,46/m	
↔ 3 m						



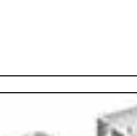











Echelles à câbles

	type	référence	 stock	page. catal.	groupe d'articles	prix en €
	Profilé de suspension 24/20F					
	Acier galvanisé à chaud	3000 709798		58	10313	122,88/m
	↔ 3 m ↔ 6 m	6000 718808		58	10313	122,88/m
	Profilé de suspension 24/20F					
	Zinkpox blanc	3000 716308		58	10302	158,91/m
	↔ 3 m ↔ 6 m	6000 720525		58	10302	158,91/m
	Profilé de suspension 24/20FS					
	Acier galvanisé à chaud	6000 709031		59	10313	173,20/m
	↔ 6 m					
	Profilé de suspension 24/20FS					
	Zinkpox blanc	6000 720526		59	10302	223,37/m
	↔ 6 m					
	Etrier de plafond TF-10					
	Acier galvanisé à chaud	TF10 788164		60	10313	20,92/pc.
	 10 pc.					
	Ecrou M10 inclus.					
	Etrier de plafond TF-16					
	Acier galvanisé à chaud	TF16 788165		60	10313	30,01/pc.
	 10 pc.					
	Ecrou M16 inclus.					
	Etrier de plafond 5					
	Acier galvanisé Sendzimir	5 721101		61	10313	10,67/pc.
	 10 pc.					
	Etrier de plafond 5					
	Acier galvanisé à chaud	5 718640		61	10313	15,43/pc.
	 10 pc.					
	Etrier de plafond 5					
	Zinkpox blanc	5 716293		61	10302	31,78/pc.
	Etrier de plafond 5					
	Acier inoxydable AISI 316L	5 725573		61	10305	51,77/pc.
	Base pour pendar 520					
	Acier galvanisé à chaud	520 718253		62	10313	196,17/pc.
	Base pour pendar 520					
Zinkpox blanc	520 718488		62	10302	256,66/pc.	

Echelles à câbles

	type	référence	 stock	page. catal.	groupe d'articles	prix en €
	Etrier pour poutre en I 5BK					
	Acier galvanisé à chaud	5BK-10	715675	✓	63	10313
	Etrier pour poutre en I 5BK					
	Zinkpox blanc	5BK-10	716294		63	10302
	Etrier de plafond 5TP					
	Acier galvanisé Sendzimir	5TP	725362		64	10313
	Etrier de plafond 5TP					
	Acier galvanisé à chaud	5TP	713153		64	10313
	Etrier de plafond 5TP					
	Zinkpox blanc	5TP	716295		64	10302
	Etrier de plafond 5TPA					
	Acier galvanisé Sendzimir	5TPA	732177	✓	65	10313
	Etrier de plafond 5TPA					
	Acier galvanisé à chaud	5TPA	733487		65	10313
	Support pour profilé 24/20F					
	Acier galvanisé à chaud	24/20F	718850		69	10313
	Support pour profilé 24/20FS					
	Zinkpox blanc	24/20F	720527		69	10302
	Support pour profilé 24/20FS					
	Acier galvanisé à chaud	24/20FS	718851		69	10313
	Support pour profilé 24/20FS					
	Zinkpox blanc	24/20FS	720528		69	10302
	Etrier mural 20					
	Acier galvanisé à chaud	20	723450		70	10313
	Etrier mural 20F					
	Acier galvanisé à chaud	20F	723451		70	10313



Echelles à câbles

	type	référence	 stock	page. catal.	groupe d'articles	prix en €	
	Etrier de plafond 20F						
	Acier galvanisé à chaud	20F	718849	71	10313	36,72/pc.	
	Etrier de plafond 20FS						
	Acier galvanisé à chaud	20FS	720536	71	10313	142,12/pc.	
	Equerre 5L						
	Acier galvanisé à chaud	5L	731791	✓	72	10313	17,48/pc.
	Zinkpox blanc	5L	731792		72	10302	34,62/pc.
	Acier inoxydable AISI 316L	5L	731793		72	10305	50,92/pc.
	 10 pc.						
	Equerre 5LS						
	Acier galvanisé à chaud	5LS	709801	✓	72	10313	20,15/pc.
	Zinkpox blanc	5LS	720529		72	10302	39,98/pc.
	Acier inoxydable AISI 316L	5LS	725636		72	10305	56,36/pc.
	Equerre HT-11						
	Acier galvanisé à chaud	HT-11	717618	✓	73	10313	21,68/pc.
	 25 pc.						
	Accouplement d'assemblage 2J						
	Acier galvanisé Sendzimir	2J	721119		74	10313	13,01/pc.
	Acier galvanisé à chaud	2J	713177		74	10313	19,28/pc.
	Zinkpox blanc	2J	716303		74	10302	25,30/pc.
	Acier inoxydable 316L	2J	726484		74	10305	104,90/pc.
	 10 pc.						
	Accouplement d'assemblage 2FJ						
	Acier galvanisé à chaud	2FJ	713178		74	10313	20,34/pc.
	Zinkpox blanc	2FJ	716304		74	10302	26,54/pc.
	Acier inoxydable 316L	2FJ	726485		74	10305	109,76/pc.
	 10 pc.						
	Accouplement d'assemblage 20J						
	Acier galvanisé à chaud	20J	713173		74	10313	38,50/pc.
	Zinkpox blanc	20J	716302		74	10302	49,47/pc.
	 10 pc.						
	Renfort 1						
	Acier galvanisé à chaud	1/ 300	717640		75	10313	28,91/pc.
		1/ 500	717641		75	10313	38,10/pc.
		1/ 800	717642		75	10313	56,76/pc.
	Renfort 1						
	Zinkpox blanc	1/ 300	717643		75	10302	46,73/pc.
		1/ 500	717644		75	10302	47,13/pc.
		1/ 800	717645		75	10302	66,42/pc.















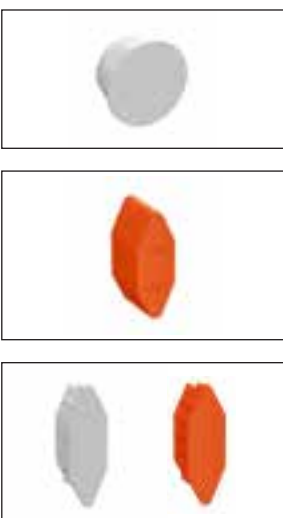

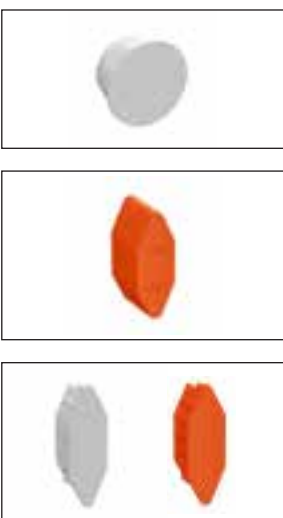
Echelles à câbles

	type	référence	 stock	page. catal.	groupe d'articles	prix en €
	Renfort 1					
	Acier galvanisé à chaud	1/ 1500	718903		75	10313 170,81/pc.
	Renfort 1					
	Zinkpox blanc	1/ 1500	720530		75	10302 190,48/pc.
	Equerre 60/40					
	Acier galvanisé à chaud	60/ 40	718904		75	10313 17,48/pc.
	Zinkpox blanc	60/ 40	720531		75	10302 29,30/pc.
	 10 pc.					
	Accouplement 21					
	Zinc+	21	795051		78	10313 14,41/pc.
	 10 pc.					
	Accouplement 21					
	Acier galvanisé à chaud	21	791199		78	10313 17,21/pc.
	 10 pc.					
	Accouplement 21					
	Zinkpox blanc	21	791200		78	10302 42,19/pc.
	 2 pc.					
	Accouplement 21					
	Acier inoxydable AISI 316L	21	725751		78	10305 37,07/pc.
	 10 pc.					
	Accouplement 9					
	Acier galvanisé Sendzimir	9	721115		79	10313 6,64/pc.
	 10 pc.					
	Accouplement 9					
	Acier galvanisé à chaud	9	705304		79	10313 10,77/pc.
	 10 pc.					
	Accouplement 9					
	Zinkpox blanc	9	714066		79	10302 17,35/pc.
	 10 pc.					
	Boulon intermédiaire 29					
	Acier galvanisé à chaud	29/ 200	705392		79	10313 24,24/pc.
		29/ 300	705394		79	10313 27,78/pc.
		29/ 400	705395		79	10313 29,83/pc.
		29/ 500	705396		79	10313 34,83/pc.
		29/ 600	705397		79	10313 35,40/pc.
	 10 pc.					

Echelles à câbles

	type	référence	stock	page. catal.	groupe d'articles	prix en €
	Accouplement de branchement 32					
	Acier galvanisé à chaud	32	734713	✓	80	10313 85,43/pc.
	 2 pc.					
	Accouplement de branchement 32					
	Zinkpox blanc	32	780874		80	10302 146,37/pc.
	 2 pc.					
	Réduction 31					
	Acier galvanisé à chaud	31/ 100	734171		80	10313 46,07/pc.
		31/ 200	734172		80	10313 56,47/pc.
		31/ 300	734173		80	10313 69,28/pc.
		31/ 400	734174		80	10313 79,89/pc.
	Réduction 31					
	Zinkpox blanc	31/ 100	735433		80	10302 77,08/pc.
		31/ 200	735434		80	10302 86,27/pc.
		31/ 300	735435		80	10302 94,94/pc.
		31/ 400	735436		80	10302 106,51/pc.
	Accouplement 22					
	Acier galvanisé Sendzimir	22	721122	✓	81	10313 16,99/pc.
	 10 pc.					
	Accouplement 22					
	Acier galvanisé à chaud	22	718409	✓	81	10313 25,83/pc.
	 10 pc.					
	Accouplement 22					
	Zinkpox blanc	22	718410	✓	81	10302 41,42/pc.
	 10 pc.					
	Accouplement 22					
	Acier inoxydable AISI 316L	22	725760	✓	81	10305 52,95/pc.
	 10 pc.					
	Dérivation fixe crochet 4					
	Aluminium	4	709017	✓	82	10313 16,41/pc.
	 10 pc.					
	Dérivation fixe crochet 4					
	Aluminium blanc	4	714067		82	10302 18,29/pc.
	 10 pc.					
	Pied d'appui 10					
	Aluminium	10	709018	✓	82	10313 14,81/pc.
	 10 pc.					
	Pied d'appui 10					
	Aluminium blanc	10	714085		82	10302 18,90/pc.
	 10 pc.					

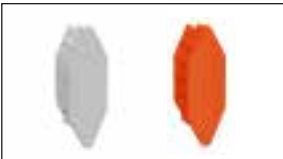
Echelles à câbles

	type	référence	stock	page. catal.	groupe d'articles	prix en €
	Etrier 41					
	Acier galvanisé Sendzimir	41	725363	✓	83	10313 16,20/pc.
	 10 pc.					
	Etrier 41					
	Acier galvanisé à chaud	41	720824	✓	83	10313 25,88/pc.
	 10 pc.					
	Etrier 41					
	Zinkpox blanc	41	721945		83	10302 28,86/pc.
 10 pc.						
	Etrier 41					
	Acier inoxydable AISI 316L	41	783374		83	10305 47,08/pc.
	 10 pc.					
	Etrier mural					
 	Acier galvanisé Sendzimir	11/ 25	721105	✓	84	10313 10,99/pc.
	 10 pc.	11/ 75	721106	✓	84	10313 12,67/pc.
	Etrier mural					
	Acier galvanisé à chaud	11/ 25	713204	✓	84	10313 16,45/pc.
	 10 pc.	11/ 75	713203	✓	84	10313 17,14/pc.
	Etrier mural					
	Zinkpox blanc	11/ 25	713208		84	10302 23,13/pc.
	 10 pc.	11/ 75	713207		84	10302 24,32/pc.
	Etrier mural					
	Acier inoxydable AISI 316L	11/ 25	725774	✓	84	10305 52,95/pc.
	 10 pc.	11/ 75	725775	✓	84	10305 58,33/pc.
		Bouchon de protection 27				
Matière synthétique gris		27	726668	✓	84	10313 1,08/pc.
 100 pc.						
	Capuchon 28					
	Matière synthétique orange	28	709019	✓	85	10313 3,60/pc.
 50 pc.						
	Capuchon 28i					
	Matière synthétique blanc	28i	735446	✓	85	10313 3,60/pc.
	Matière synthétique orange	28i	731994	✓	85	10313 4,48/pc.
	 10 pc.					









Echelles à câbles

	type	référence	stock	page. catal.	groupe d'articles	prix en €
	Profilé de protection 28P					
	Matière synthétique gris	28P	732151	✓	85	10313
	↔ 2 m					
	Capuchon 28C					
	Matière synthétique orange	28C	789875		86	10313
	📦 50 pc. • Pour pendard 2 et profilé 24/34.					
	Capuchon 28E					
	Matière synthétique orange	28E	709021	✓	86	10313
	📦 50 pc. • Pour pendard 2F et 20F et profilé de suspension 24/48 et 24/20F.					
	Capuchon 28D					
	Matière synthétique orange	28D	709020	✓	86	10313
	📦 50 pc. • Pour pendard 20 et profilé de suspension 24/20.					
	Capuchon 28F					
	Matière synthétique orange	28F	789876		86	10313
	📦 10 pc. • Pour pendard 20FS et profilé de suspension 24/20FS.					
	Cornière 33/1					
	Acier galvanisé Sendzimir	33/ 1	768733		86	10313
	Cornière 33/1					
	Acier inoxydable AISI 316L	33/ 1	727340		86	10305
	Cornière 33/2					
	Acier galvanisé Sendzimir	33/ 2	721114		86	10313
	Cornière 33/2					
	Acier galvanisé à chaud	33/ 2	707748		86	10313
	Cornière 33/2					
	Zinkpox blanc	33/ 2	714168		86	10302
	Cornière 33/2					
	Acier inoxydable AISI 316L	33/ 2	727197		86	10305







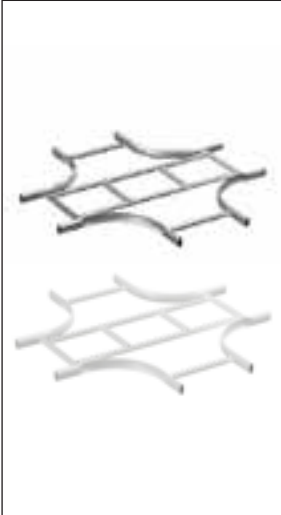









Echelles à câbles

	type	référence	stock	page. catal.	groupe d'articles	prix en €	
	Courbe intérieure 90°,15						
	Acier galvanisé Sendzimir	15/ 200	723061	✓	87	10313	160,38/pc.
		15/ 300	723062	✓	87	10313	170,21/pc.
		15/ 400	723063	✓	87	10313	173,27/pc.
		15/ 500	723064	✓	87	10313	203,37/pc.
		15/ 600	723065	✓	87	10313	211,04/pc.
	Courbe intérieure 90°,15						
	Acier galvanisé à chaud	15/ 150	716066	✓	87	10313	217,80/pc.
		15/ 200	716067	✓	87	10313	217,80/pc.
		15/ 300	716069	✓	87	10313	231,06/pc.
		15/ 400	716070	✓	87	10313	233,38/pc.
		15/ 500	716071	✓	87	10313	249,58/pc.
		15/ 600	716072	✓	87	10313	268,80/pc.
		15/ 800	716071		87	10313	472,25/pc.
		15/ 1000	716073		87	10313	545,23/pc.
	Courbe intérieure 90°,15						
	Zinkpox blanc	15/ 150	716074		87	10302	271,01/pc.
		15/ 200	716075		87	10302	298,19/pc.
		15/ 300	716077		87	10302	329,13/pc.
15/ 400		716078		87	10302	352,63/pc.	
15/ 500		716079		87	10302	398,95/pc.	
15/ 600		716080		87	10302	400,93/pc.	
15/ 800		728043		87	10302	523,51/pc.	
15/ 1000		716081		87	10302	601,00/pc.	
Courbe intérieure 90°,15							
Acier inoxydable AISI 316L	15/ 150	727346		87	10305	577,68/pc.	
	15/ 200	727347		87	10305	606,55/pc.	
	15/ 300	727348		87	10305	681,73/pc.	
	15/ 400	727349		87	10305	762,45/pc.	
	15/ 500	727350		87	10305	808,76/pc.	
	15/ 600	727351		87	10305	866,62/pc.	
	15/ 800	783376		87	10302	sur demande	
	15/ 1000	783377		87	10302	sur demande	
Courbe extérieure 90°, 15							
Acier galvanisé à chaud	15/ 150	716179		87	10313	323,19/pc.	
	15/ 200	716180	✓	87	10313	345,82/pc.	
	15/ 300	716182	✓	87	10313	370,85/pc.	
	15/ 400	716183	✓	87	10313	403,37/pc.	
	15/ 500	716184		87	10313	442,21/pc.	
	15/ 600	716185	✓	87	10313	448,63/pc.	
	15/ 800	723057		87	10313	638,99/pc.	
	15/ 1000	723260		87	10313	877,47/pc.	
Courbe extérieure 90°, 15							
Zinkpox blanc	15/ 150	716186		87	10302	360,47/pc.	
	15/ 200	716187		87	10302	410,27/pc.	
	15/ 300	716189		87	10302	463,16/pc.	
	15/ 400	716190		87	10302	529,85/pc.	
	15/ 500	716191		87	10302	681,30/pc.	
	15/ 600	716192		87	10302	691,67/pc.	
	15/ 800	728052		87	10302	879,21/pc.	
	15/ 1000	728053		87	10302	1198,08/pc.	
Courbe extérieure 90°, 15							
Acier inoxydable AISI 316L	15/ 150	727352		87	10305	1452,82/pc.	
	15/ 200	727353		87	10305	739,44/pc.	
	15/ 300	727354		87	10305	814,43/pc.	
	15/ 400	727355		87	10305	941,43/pc.	
	15/ 500	727356		87	10305	1352,69/pc.	
	15/ 600	727357		87	10305	939,58/pc.	







Echelles à câbles

	type	référence	stock	page. catal.	groupe d'articles	prix en €
	Accouplement 14					
	Acier galvanisé Sendzimir	14	723212	✓	88	10313 43,99/pc.
	 10 pc.					
	Accouplement 14					
	Acier galvanisé à chaud	14	725096	✓	88	10313 69,28/pc.
	 10 pc.					
	Accouplement 14					
	Zinkpox blanc	14	790906		88	10302 76,34/pc.
 2 pc.						
	Accouplement 14					
	Acier inoxydable AISI 316L	14	727195		88	10305 108,22/pc.
	 10 pc.					
	Pièce en T 16					
	Acier galvanisé à chaud	16/ 150	716193		88	10313 239,83/pc.
		16/ 200	716194	✓	88	10313 243,51/pc.
		16/ 300	716196	✓	88	10313 252,37/pc.
		16/ 400	716197	✓	88	10313 268,60/pc.
		16/ 500	716198	✓	88	10313 273,79/pc.
		16/ 600	716199	✓	88	10313 290,02/pc.
		16/ 800	721962		88	10313 673,93/pc.
		16/ 1000	716200		88	10313 667,09/pc.
	Pièce en T 16					
	Zinkpox blanc	16/ 150	716201		88	10302 547,35/pc.
		16/ 200	716202		88	10302 414,43/pc.
		16/ 300	716204		88	10302 454,38/pc.
	16/ 400	716205		88	10302 479,26/pc.	
	16/ 500	716206		88	10302 534,94/pc.	
	16/ 600	716207		88	10302 536,04/pc.	
	16/ 1000	716208		88	10302 743,17/pc.	
Pièce en T 16						
Acier inoxydable AISI 316L	16/ 150	727358		88	10305 831,76/pc.	
	16/ 200	727359		88	10305 751,03/pc.	
	16/ 300	727360		88	10305 843,39/pc.	
	16/ 400	727361		88	10305 947,33/pc.	
	16/ 500	727362		88	10305 1080,28/pc.	
	16/ 600	727363		88	10305 1299,79/pc.	
Croisillon 17						
	Acier galvanisé à chaud	17/ 150	716209		89	10313 374,15/pc.
		17/ 200	716210		89	10313 375,63/pc.
		17/ 300	716212		89	10313 384,47/pc.
		17/ 400	716213		89	10313 397,75/pc.
		17/ 500	716214		89	10313 406,61/pc.
		17/ 600	716215		89	10313 418,42/pc.
		17/ 800	721963		89	10313 1045,20/pc.
		17/ 1000	716216		89	10313 589,63/pc.
	Croisillon 17					
Zinkpox blanc	17/ 150	716217		89	10302 602,39/pc.	
	17/ 200	716218		89	10302 654,59/pc.	
	17/ 300	716220		89	10302 707,22/pc.	
	17/ 400	716221		89	10302 738,31/pc.	
	17/ 500	716222		89	10302 770,03/pc.	
	17/ 600	716223		89	10302 824,69/pc.	
	17/ 1000	716224		89	10302 1156,88/pc.	





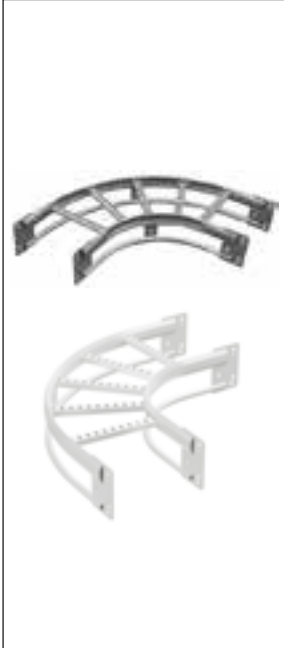

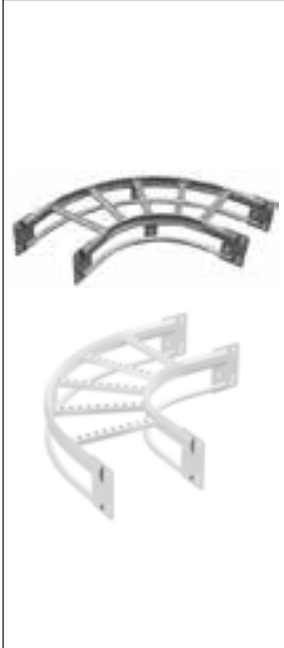
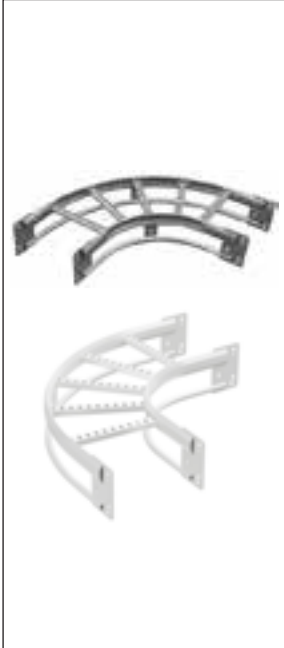
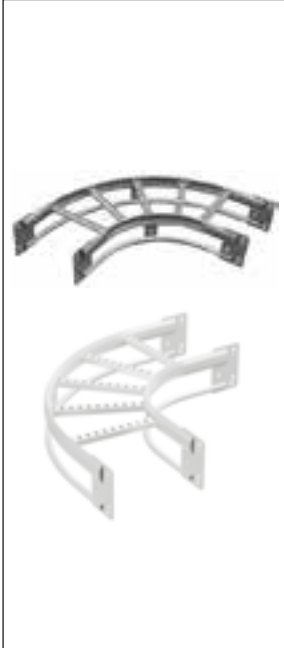









Echelles à câbles

	type	référence	stock	page. catal.	groupe d'articles	prix en €
	Pièce de montée 18					
	Acier galvanisé à chaud	18/ 150	718176	✓	90	10313 250,21/pc.
		18/ 200	718177	✓	90	10313 261,17/pc.
		18/ 300	718179	✓	90	10313 267,62/pc.
		18/ 400	718180	✓	90	10313 283,04/pc.
		18/ 500	718181	✓	90	10313 287,34/pc.
		18/ 600	718182	✓	90	10313 297,27/pc.
		18/ 800	721964		90	10313 363,82/pc.
		18/ 1000	718183		90	10313 385,76/pc.
		Pièce de montée 18				
Zinkpox blanc		18/ 150	718184		90	10302 279,02/pc.
		18/ 200	718185		90	10302 291,24/pc.
		18/ 300	718187		90	10302 298,45/pc.
		18/ 400	718188		90	10302 315,64/pc.
		18/ 500	718189		90	10302 321,61/pc.
		18/ 600	718190		90	10302 325,27/pc.
		18/ 800	728034		90	10302 499,21/pc.
		18/ 1000	718191		90	10302 453,59/pc.
		Pièce de montée 18				
	Acier inoxydable AISI 316L	18/ 150	727370		90	10305 542,85/pc.
		18/ 200	727371		90	10305 485,25/pc.
		18/ 300	727372		90	10305 582,29/pc.
		18/ 400	727373		90	10305 612,29/pc.
		18/ 500	727374		90	10305 644,67/pc.
	Courbe en S 67					
	Acier galvanisé à chaud	67	788638		91	10313 113,25/pc.
	Accouplement 45					
	Acier galvanisé à chaud	45	707609	✓	92	10313 70,47/pc.
	 2 pc.					
	Accouplement 45					
	Zinkpox blanc	45	714227		92	10302 78,54/pc.
 2 pc.						
	Accouplement 45					
	Acier inoxydable AISI 316L	45	792873	✓	92	10305 101,29/pc.
 2 pc.						
	Dérivation crochet 47					
	Acier galvanisé à chaud	47	791350	✓	92	10313 50,00/pc.
 2 pc.						
	Dérivation crochet 47					
	Zinkpox blanc	47	791401		92	10302 83,99/pc.
 2 pc.						
	Dérivation crochet 47					
	Acier inoxydable AISI 316L	47	792875		92	10305 sur demande
 2 pc.						





















Echelles à câbles

	type	référence	stock	page. catal.	groupe d'articles	prix en €
	Soutien pour profilé 46					
	Acier galvanisé à chaud	46	708001	✓	93	10313 22,02/pc.
	 10 pc.					
	Soutien pour profilé 46					
	Zinkpox blanc	46	714179		93	10302 31,14/pc.
	 10 pc.					
	Soutien pour profilé 46					
	Acier inoxydable AISI 316L	46	792877		93	10305 44,52/pc.
	 10 pc.					
	Pièce de montée 49					
	Acier galvanisé à chaud	49/ 200	716389	✓	93	10313 235,88/pc.
		49/ 300	716390	✓	93	10313 240,28/pc.
		49/ 400	716391	✓	93	10313 242,33/pc.
		49/ 500	720517		93	10313 243,37/pc.
		49/ 600	716392	✓	93	10313 243,37/pc.
		49/ 1000	716393		93	10313 277,92/pc.
	Pièce de montée 49					
	Zinkpox blanc	49/ 200	716395		93	10302 252,05/pc.
		49/ 300	716396		93	10302 259,45/pc.
	49/ 400	716397		93	10302 275,23/pc.	
	49/ 500	720518		93	10302 286,91/pc.	
	49/ 600	716398		93	10302 298,86/pc.	
	49/ 1000	716399		93	10302 310,85/pc.	
	Pièce de montée 49					
	Acier inoxydable AISI 316L	49/ 200	792880		93	10305 429,52/pc.
		49/ 300	792881		93	10305 431,06/pc.
		49/ 400	792882		93	10305 432,55/pc.
		49/ 500	792883		93	10305 434,54/pc.
		49/ 600	792884		93	10305 436,26/pc.
		49/ 1000	792886		93	10305 sur demande
	Courbe 90°, 55					
	Acier galvanisé à chaud	55/ 200	716241	✓	94	10313 435,40/pc.
		55/ 300	716243	✓	94	10313 447,95/pc.
	55/ 400	716244	✓	94	10313 458,99/pc.	
	55/ 500	716245		94	10313 479,67/pc.	
	55/ 600	716246	✓	94	10313 481,87/pc.	
	55/ 1000	716247		94	10313 813,95/pc.	
	Courbe 90°, 55					
	Zinkpox blanc	55/ 200	716248		94	10302 642,46/pc.
		55/ 300	716250		94	10302 692,65/pc.
		55/ 400	716251		94	10302 696,86/pc.
		55/ 500	720252		94	10302 sur demande
		55/ 600	716253		94	10302 818,21/pc.
		55/ 1000	716254		94	10302 966,24/pc.
	Courbe 90°, 55					
	Acier inoxydable AISI 316L	55/ 200	792903		94	10305 1290,83/pc.
		55/ 300	792904		94	10305 1351,57/pc.
		55/ 400	792905		94	10305 1521,85/pc.
		55/ 500	792906		94	10305 1675,87/pc.
		55/ 600	792907		94	10305 1725,08/pc.
		55/ 1000	792909		94	10305 sur demande





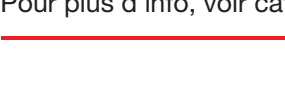



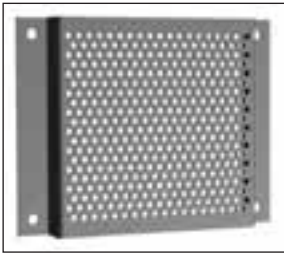

Echelles à câbles

	type	référence	 stock	page. catal.	groupe d'articles	prix en €
	Pièce en T 56					
	Acier galvanisé à chaud	56/ 200	716255	94	10313	612,49/pc.
		56/ 300	716257	94	10313	627,25/pc.
		56/ 400	716258	94	10313	637,59/pc.
		56/ 500	716259	94	10313	655,27/pc.
		56/ 600	716260	94	10313	656,03/pc.
	56/ 1000	716261	94	10313	1070,03/pc.	
	Pièce en T 56					
	Zinkpox blanc	56/ 200	716262	94	10302	1062,13/pc.
		56/ 300	716264	94	10302	1145,03/pc.
		56/ 400	716265	94	10302	1174,88/pc.
		56/ 500	720266	94	10302	sur demande
		56/ 600	716267	94	10302	1279,71/pc.
	56/ 1000	716268	94	10302	1505,10/pc.	
	Pièce en T 56					
	Acier inoxydable AISI 316L	56/ 200	792920	94	10305	1759,15/pc.
		56/ 300	792921	94	10305	1915,30/pc.
		56/ 400	792922	94	10305	2077,72/pc.
		56/ 500	792923	94	10305	2077,72/pc.
		56/ 600	792924	94	10305	2181,92/pc.
	Boulonnerie M12					
	Acier galvanisé à chaud	M12	706415		95	10313 13,49/set
	 25 sets					
	Boulonnerie M12					
	Acier inoxydable AISI 316L	M12	728767		95	10305 39,71/pc.
	 25 sets					
	Etrier 200 pour luminaire					
	Acier galvanisé à chaud	200	718643		95	10313 34,83/pc.
	Zinkpox blanc	200	718644		95	10302 38,32/pc.
	 10 pc.					
	Accouplement 44					
	Acier galvanisé à chaud	44	720815		96	10313 95,88/pc.
	 2 pc.					
	Accouplement 44					
Zinkpox blanc	44	720816		96	10302 108,27/pc.	
 2 pc.						
	Accouplement 44					
Acier inoxydable AISI 316L	44	792888		96	10305 171,72/pc.	
 2 pc.						

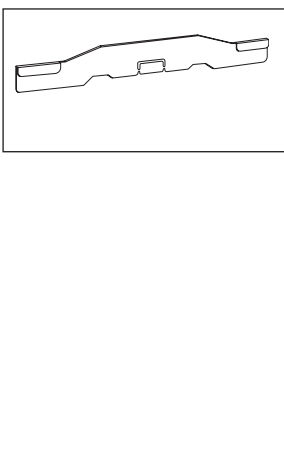

Echelles à câbles

	type	référence	 stock	page. catal.	groupe d'articles	prix en €
	Accouplement 51					
	Acier galvanisé à chaud	51	731837		97	10313 149,62/pc.
	 2 pc.					
	Accouplement 51					
	Zinkpox blanc	51	731911		97	10302 210,97/pc.
	 2 pc.					
	Accouplement 51					
	Acier inoxydable AISI 316L	51	731914		97	10305 324,94/pc.
	 2 pc.					
	Plaque de montage 35P					
	Acier galvanisé Sendzimir	35P	718618		98	10313 26,17/pc.
	 10 pc.					
	Plaque de montage 35P					
	Acier galvanisé à chaud	35P	731745		98	10313 28,42/pc.
	 10 pc.					
	Plaque de montage 35P					
	Acier inoxydable AISI 316L	35P	725777		98	10305 54,89/pc.
	Plaque de montage 35S					
	Acier galvanisé Sendzimir	35S	711205		99	10313 28,30/pc.
	 10 pc.					
	Plaque de montage 35S					
	Acier galvanisé à chaud	35S	731746		99	10313 31,59/pc.
	 10 pc.					
	Plaque de montage 35S					
	Acier inoxydable AISI 316L	35S	725776		99	10305 45,69/pc.
	 10 pc.					
	Plaque de montage 35S					
	Acier galvanisé Sendzimir	35S	730245		99	10313 26,50/pc.
	 10 pc.					
	Borne de terre W79					
	Acier à zingage électrolytique	W79	716640		99	10313 4,84/pc.
	 100 pc.					





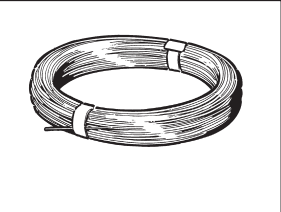







Echelles à câbles

	type	référence	 stock	page. catal.	groupe d'articles	prix en €	
	Plaque de montage 62						
	Acier galvanisé Sendzimir	62/100	783460		100	10313	22,09/pc.
		62/200	783461		100	10313	28,42/pc.
	Cloison de séparation 39						
	Acier galvanisé Sendzimir	H=24 L=1,75m	718835		103	10313	11,82/pc.
	 50 pc.						
	Cloison de séparation 39						
	Acier galvanisé à chaud	H=24 L=1,75m	731747	✓	103	10313	18,94/pc.
	 50 pc.						
	Cloison de séparation 39						
	Acier inoxydable AISI 316L	H=24 L=1,75m	725593		103	10305	65,45/pc.
	 50 pc.						
	Cloison de séparation 39						
	Acier galvanisé Sendzimir	H=55 L=1,75m	725785	✓	103	10313	12,95/pc.
	 30 pc.						
	Cloison de séparation 39						
	Acier galvanisé à chaud	H=55 L=1,75m	732983	✓	103	10313	22,31/pc.
	 30 pc.						
	Cloison de séparation 39						
	Acier inoxydable AISI 316L	H=55 L=1,75m	725594		103	10305	95,99/pc.
	 30 pc.						
	Accouplement W39 pour cloison de séparation 39						
	Matière synthétique	W39	716824	✓	103	10313	5,80/pc.
	 10 pc.						

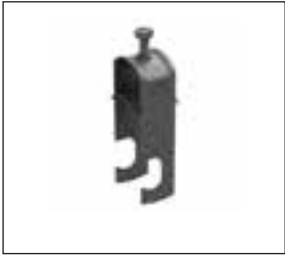
Echelles à câbles

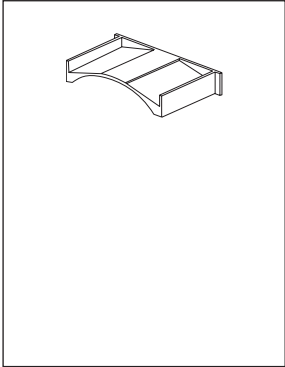
	type	référence	stock	page. catal.	groupe d'articles	prix en €		
	Plaque de protection 65							
	Acier galvanisé Sendzimir L=1m	200	732475		104	10313	257,98/pc.	
		300	732476		104	10313	267,35/pc.	
		400	732477		104	10313	304,50/pc.	
		500	732478		104	10313	325,37/pc.	
		600	732479		104	10313	332,38/pc.	
	Plaque de protection 65							
	Acier galvanisé à chaud L=1m	200	730192		104	10313	290,56/pc.	
		300	730193		104	10313	302,16/pc.	
		400	730194		104	10313	337,01/pc.	
		500	730195		104	10313	371,92/pc.	
		600	730196		104	10313	412,61/pc.	
	Plaque de protection 65							
	Acier inoxydable AISI 316L L=1m	200	732481		104	10305	993,29/pc.	
		300	732482		104	10305	1258,10/pc.	
400		732483		104	10305	1307,87/pc.		
500		732484		104	10305	1790,00/pc.		
600		732485		104	10305	1821,06/pc.		
	Fil à nouer							
	INOX, blanc PVC, ø 1,25 mm	HTR-2303	713686		105	10313	2,48/m	
	INOX, noir PVC, ø 1,25 mm	HTR-2313	713687		105	10313	2,76/m	
	blanc PVC, ø 1,5 mm	HTR-2304	713684		105	10313	0,83/m	
	noir PVC, ø 1,5 mm	HTR-2314	713685	✓	105	10313	0,83/m	
↔ 100 m								
	Goulotte télé- et datacom 36							
	Acier galvanisé Sendzimir ↔ 2 m	36/ 50	725065		106	10313	12,02/m	
		36/ 100	725066		106	10313	13,11/m	
		36/ 200	725067		106	10313	15,85/m	
	Goulotte télé- et datacom 36							
	Acier galvanisé à chaud ↔ 2 m	36/ 50	731748		106	10313	17,48/m	
		36/ 100	731749		106	10313	23,48/m	
		36/ 200	731750		106	10313	33,67/m	
	Goulotte télé- et datacom 36							
	Acier inoxydable AISI 316L ↔ 2 m	36/ 50	725590		106	10305	59,37/m	
		36/ 100	725591		106	10305	92,23/m	
		36/ 200	725592		106	10305	149,37/m	
		Etrier 12/70 ou 12/120						
		Acier galvanisé à chaud	12/70	728653	✓	108	10313	31,09/pc.
			12/ 120	728654	✓	108	10313	33,58/pc.
📦 10 pc.								
Etrier 12/70 ou 12/120								
Acier inoxydable AISI 316L	12/70	728651		108	10305	45,16/pc.		
	12/ 120	728652		108	10305	50,48/pc.		
📦 10 pc.								

Echelles à câbles

	type	référence	stock	page. catal.	groupe d'articles	prix en €
	Crochet 8					
	Acier galvanisé à chaud	728642		108	10313	13,91/pc.
	 10 pc.					
	Crochet 8					
	Acier inoxydable AISI 316L	728643		108	10305	26,58/pc.
	 10 pc.					
	Pince à câbles, type ARX, pour 1 câble					
	Zink+	ARX1-12	795600	-	10313	4,47/pc.
	 50 pc.	ARX1-16	795601	-	10313	4,83/pc.
		ARX1-22	795602	-	10313	4,89/pc.
		ARX1-28	795603	-	10313	5,27/pc.
		ARX1-36	795604	-	10313	5,49/pc.
		ARX1-44	795605	-	10313	5,68/pc.
		ARX1-52	795606	-	10313	5,93/pc.
		ARX1-60	795607	-	10313	7,37/pc.
		ARX1-70	795608	-	10313	8,12/pc.
	Pince à câbles, type ARX, pour 2 câbles					
	Zink+	ARX2-12	795609	-	10313	4,96/pc.
	 50 pc.	ARX2-16	795610	-	10313	5,13/pc.
		ARX2-22	795611	-	10313	5,49/pc.
		ARX2-28	795612	-	10313	5,76/pc.
		ARX2-36	795613	-	10313	6,38/pc.
		ARX2-44	795614	-	10313	7,00/pc.
		ARX2-52	795615	-	10313	8,43/pc.
		ARX2-60	795616	-	10313	8,70/pc.
	Protège-câble EM					
	Matière synthétique gris	EM - 12	709050	111	10313	2,62/pc.
	 100 pc.	EM - 16	709051	111	10313	2,62/pc.
		EM - 22	709052	111	10313	2,90/pc.
		EM - 28	709053	111	10313	2,90/pc.
	 50 pc.	EM - 36	709054	111	10313	2,90/pc.
		EM - 44	709055	111	10313	3,54/pc.
	 25 pc.	EM - 52	709056	111	10313	3,54/pc.
		EM - 60	709057	111	10313	3,54/pc.
EM - 70		709058	111	10313	3,54/pc.	
	Pince à câbles, type ER					
	Acier inoxydable AISI 316	23 - 28	736440	112	10313	184,01/pc.
		27 - 32	736441	112	10313	187,73/pc.
		30 - 35	736442	112	10313	190,07/pc.
		33 - 38	736443	112	10313	192,59/pc.
		36 - 42	736444	112	10313	205,00/pc.
		40 - 46	736445	112	10313	208,76/pc.
		44 - 50	736446	112	10313	212,47/pc.
		48 - 55	736447	112	10313	233,37/pc.
		51 - 58	736448	112	10313	237,11/pc.
		55 - 62	736449	112	10313	240,74/pc.
		59 - 66	736450	112	10313	275,26/pc.
		63 - 70	736451	112	10313	279,02/pc.
		67 - 74	736452	112	10313	282,72/pc.
	71 - 78	736453	112	10313	314,93/pc.	
	74 - 82	736454	112	10313	318,57/pc.	
	77 - 85	736455	112	10313	321,01/pc.	

Echelles à câbles

	type	référence	stock	page. catal.	groupe d'articles	prix en €
	Adaptateur pour pince ER					
	Acier inoxydable AISI 316	736456		112	10313	28,46/pc.
	 50 pc.					
	Pour échelon rond set de montage 74S inclus.					
	Boulonnerie 74S					
	Acier inoxydable AISI 316	74S	737198	112	10313	10,83/pc.
	 10 pc.					
	Deux sets sont nécessaire pour montage sur un échelon perforé.					
	Enrouleuse de câbles S					
	Acier galvanisé à chaud/ matière synthétique	S	718660	✓	114	10313 476,28/pc.
	Enrouleuse de câbles 38					
	Acier inoxydable/ matière synthétique	38	735998		115	10313 476,28/pc.
	Sac					
	Matière synthétique		780186		115	10313 442,77/pc.
	Set enrouleuses de câbles 66					
	Set composé de 1 sac et 10 enrouleuses 38.	66	780187		115	10313 4945,44/set
	Plaquette de marquage 93					
	Acier, laqué					
	jaune, RAL 1018	93	737704		116	10313 30,21/pc.
	orange, RAL 2008	93	737705		116	10313 30,21/pc.
	bleu, RAL 5012	93	737706		116	10313 30,21/pc.
	vert, RAL 6032	93	737707		116	10313 30,21/pc.
	noir, RAL 9005	93	737708		116	10313 30,21/pc.
	 10 pc.					
	Anti-corrosion zinc "GALVAFROID"					
	Pot 0,3 l		717637	✓	116	10313 112,16/pc.
	Peinture de retouche blanc					
	Bombe		739713		116	10302 130,12/pc.

Echelles à câbles

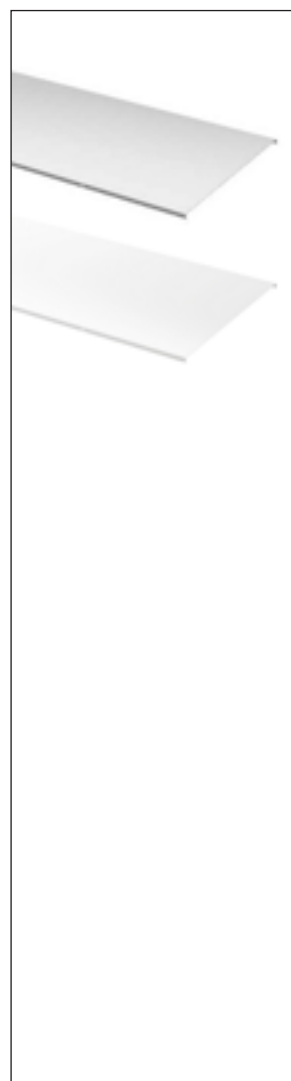

Couvercle W5

	type	référence	stock	page. catal.	groupe d'articles	prix en €
←→ 2 m	Acier galvanisé Sendzimir	150	732216	117	10313	14,08/m
		200	732217	117	10313	17,30/m
		300	732218	117	10313	22,99/m
		400	732219	117	10313	33,63/m
		500	732220	117	10313	39,08/m
		600	732221	117	10313	53,83/m
		1000	732222	117	10313	133,26/m

Couvercle W5

←→ 2 m	Acier galvanisé à chaud	150	732264	117	10313	34,92/m
		200	732265	117	10313	36,02/m
		300	732266	117	10313	45,73/m
		400	732267	117	10313	58,71/m
		500	732268	117	10313	59,79/m
		600	732269	117	10313	71,69/m
		800	782213	117	10313	257,30/m
		1000	732270	117	10313	158,47/m

Couvercle W5

←→ 2 m	Zinkpox blanc	150	782365	117	10302	94,27/m
		200	782366	117	10302	81,84/m
		300	782367	117	10302	109,85/m
		400	782368	117	10302	134,41/m
		500	782369	117	10302	156,35/m
		600	782370	117	10302	179,99/m
		800	782214	117	10302	sur demande
		1000	782371	117	10302	374,08/m

Couvercle W5

←→ 2 m	Acier inoxydable AISI 316L	150	732291	117	10305	111,98/m
		200	732292	117	10305	143,67/m
		300	732293	117	10305	180,15/m
		400	732294	117	10305	267,78/m
		500	732295	117	10305	318,62/m
		600	732296	117	10305	331,10/m
		800	783375	117	10305	752,80/m
		1000	732297	117	10305	834,49/m

Raccord de couvercle













	Acier galvanisé Sendzimir	150	712639	118	10313	15,78/pc.
		200	712640	118	10313	17,10/pc.
		300	712642	118	10313	17,38/pc.
		400	712643	118	10313	20,42/pc.
		500	712644	118	10313	24,59/pc.
		600	712645	118	10313	26,32/pc.

Raccord de couvercle













	Acier galvanisé à chaud	150	780452	118	10313	39,35/pc.
		200	780453	118	10313	41,18/pc.
		300	780454	118	10313	44,90/pc.
		400	780455	118	10313	46,81/pc.
		500	780456	118	10313	50,55/pc.
		600	780457	118	10313	52,42/pc.













Echelles à câbles

	type	référence	stock	page. catal.	groupe d'articles	prix en €	
	Support de couvercle 37						
	Acier galvanisé Sendzimir	37	729217	✓	119	10313	6,62/pc.
	 10 pc.						
	Support de couvercle 37						
	Acier galvanisé à chaud	37	730188	✓	119	10313	8,63/pc.
	 10 pc.						
	Support de couvercle 37						
	Zinkpox blanc	37	782382		119	10302	12,47/pc.
 10 pc.							
	Support de couvercle 37						
	Acier inoxydable AISI 316L	37	730190		119	10305	18,56/pc.
	 10 pc.						
	Etrier de couvercle						
	Zinc+		795598	✓	119	10313	6,84/pc.
	 10 pc.						
	Etrier de couvercle						
	Zinkpox blanc		782384		119	10312	sur demande
 10 pc.							
	Etrier de couvercle						
	Acier inoxydable AISI 316L		728586		119	10305	9,20/pc.
	 10 pc.						
	Couvercle courbe 90°						
	Acier galvanisé Sendzimir	150	732322		120	10313	150,91/pc.
		200	732323		120	10313	166,93/pc.
		300	732324		120	10313	193,17/pc.
		400	732325		120	10313	235,88/pc.
		500	732326		120	10313	281,14/pc.
		600	732327		120	10313	304,50/pc.
		800	781802		120	10313	376,41/pc.
		1000	732328		120	10313	396,97/pc.
	Couvercle courbe 90°						
	Acier galvanisé à chaud	150	781433		120	10313	119,94/pc.
		200	781434		120	10313	150,49/pc.
		300	781435		120	10313	169,33/pc.
		400	781436		120	10313	210,58/pc.
	500	781437		120	10313	223,66/pc.	
	600	781438		120	10313	254,74/pc.	
	800	781793		120	10313	730,87/pc.	
	1000	781439		120	10313	467,64/pc.	
Couvercle courbe 90°							
Zinkpox blanc	150	781751		120	10302	155,31/pc.	
	200	781752		120	10302	178,43/pc.	
	300	781753		120	10302	224,43/pc.	
	400	781754		120	10302	295,77/pc.	
	500	781755		120	10302	336,21/pc.	
	600	781756		120	10302	394,04/pc.	
	800	781794		120	10302	927,87/pc.	
	1000	781757		120	10302	806,54/pc.	

Echelles à câbles

	type	référence	 stock	page. catal.	groupe d'articles	prix en €
	Couvercle courbe 90°					
	Acier inoxydable AISI 316L	150	788639	120	10305	175,26/pc.
		200	788640	120	10305	194,53/pc.
		300	788641	120	10305	257,65/pc.
		400	788642	120	10305	470,01/pc.
		500	788643	120	10305	494,30/pc.
		600	788644	120	10305	656,03/pc.
		800	788645	120	10305	1166,33/pc.
	1000	788646	120	10305	2388,97/pc.	
	Couvercle pièce en T					
	Acier galvanisé Sendzimir	150	732345	121	10313	169,00/pc.
		200	732346	121	10313	205,75/pc.
		300	732347	121	10313	224,07/pc.
		400	732348	121	10313	240,38/pc.
		500	732349	121	10313	278,95/pc.
		600	732350	121	10313	309,10/pc.
		800	781803	121	10313	525,42/pc.
		1000	732351	121	10313	466,66/pc.
		Couvercle pièce en T				
Acier galvanisé à chaud		150	781440	121	10313	148,18/pc.
		200	781441	121	10313	174,64/pc.
		300	781442	121	10313	210,00/pc.
		400	781443	121	10313	254,95/pc.
		500	781444	121	10313	308,93/pc.
		600	781445	121	10313	334,75/pc.
		800	781796	121	10313	694,76/pc.
		1000	781446	121	10313	868,10/pc.
		Couvercle pièce en T				
	Zinkpox blanc	150	781765	120	10302	208,62/pc.
		200	781766	120	10302	245,65/pc.
		300	781767	120	10302	360,79/pc.
		400	781768	120	10302	365,55/pc.
		500	781769	120	10302	474,88/pc.
		600	781770	120	10302	519,90/pc.
		1000	781771	120	10302	1150,84/pc.
	Couvercle pièce en T					
	Acier inoxydable AISI 316L	150	788647	121	10305	244,62/pc.
		200	788648	121	10305	301,85/pc.
		300	788649	121	10305	369,39/pc.
		400	788650	121	10305	673,93/pc.
		500	788651	121	10305	1150,67/pc.
		600	788652	121	10305	1167,21/pc.
		800	788653	121	10305	2426,57/pc.
	1000	781654	121	10305	sur demande	
	Set de montage 2S					
	Acier galvanisé à chaud	M8x40	715735		130	10313
 10 pc.						
	Set de montage 20S					
	Acier galvanisé à chaud	M8x60	715736		130	10313
 10 pc.						

Echelles à câbles

	type	référence	stock	page. catal.	groupe d'articles	prix en €	
	Set de montage 22S						
	Acier galvanisé à chaud	M8x16	713694	✓	130	10313	1,07/pc.
	 10 pc.						
	Set de montage 22S						
	Acier inoxydable AISI 316L	M8x16	725582		130	10305	9,11/pc.
	 10 pc.						
	Ecrou coulissant pour échelons perforés						
	Acier galvanisé à chaud	M8	718632	✓	131	10313	4,10/pc.
	 10 pc.						
	Boulon en T 26U						
	Acier à zingage électrolytique	M8x30	795594	✓	-	10313	6,47/pc.
		M10x30	795588	✓	-	10313	6,57/pc.
	 10 pc.						
	Boulon en T 26U						
	Acier galvanisé à chaud	M8x30	795595	✓	-	10313	6,65/pc.
		M10x30	795589	✓	-	10313	6,70/pc.
		M10x40	795590	✓	-	10313	8,85/pc.
	 10 pc.	M10x50	795591	✓	-	10313	9,60/pc.
	Boulon en T 26U						
	Acier inoxydable AISI 316L	M8x30	795596		-	10305	71,52/pc.
		M10x30	795592		-	10305	66,08/pc.
	 10 pc.	M10x50	795593		-	10305	70,13/pc.



KG 281

KG 281

KG 281

KB 184

W4

Gaines à câbles KG 281

Chemins de câbles KB 184

Gaines et chemins de câbles W4

- ✓ La gamme la plus complète de gaines et chemins de câbles.
- ✓ Un choix étendu d'accessoires.
- ✓ Des raccordements sans vis, tels que des éclisses à boulonner, des ressorts d'accouplement, des verrous, des plaques de montage, etc. qui sont en outre faciles à monter et peu coûteux.
- ✓ Un choix étendu de fixations (encliquetables), adaptées à chaque sens de montage.
- ✓ Grâce au double rebord :
 - solidité renforcée ;
 - aucun risque d'endommagement du matériel ou de blessure ;
 - aucun endommagement lors de la pose de câbles.
- ✓ Esthétiquement les plus belles gaines/les plus beaux chemins de câbles :
 - élégants et jolis ;
 - disponibles en finition laquée, résistants aux rayures.



© Severin Maltaud

Les gaines à câbles STAGO

Design et fonctionnalité vont de pair

Les gaines à câbles constituent une partie importante de l'installation électrique. Après tout, les câbles doivent être transportés à travers le bâtiment d'une manière simple.

La flexibilité et la facilité de montage sont des caractéristiques essentielles pour un tel système de porteurs de câbles.

Mais saviez-vous que les gaines à câbles ont également une **valeur esthétique** ? Alors qu'on les installait auparavant exclusivement au-dessus du faux plafond, elles sont à présent montées de façon apparente selon la tendance du **look industriel**. La gamme des gaines à câbles STAGO en **version métallique et laquée** s'intègre parfaitement dans le nouvel intérieur industriel élégant qui regorge de matériaux robustes aux accents métalliques ou laqués. Conformément à cette nouvelle tendance, les bureaux, les magasins, les entreprises de restauration, ainsi que les habitations privées sont équipés de ces gaines à câbles STAGO originales, ce qui permet de parfaitement combiner l'aspect fonctionnel avec le nouveau look industriel.

Les gaines à câbles STAGO:
une touche d'originalité dans tout
intérieur moderne et industriel!

Les caractéristiques du système de gaines à câbles STAGO en un clin d'œil :



- Fonctionnel
- Élégant – adapté à tout intérieur industriel moderne
- Esthétique et épuré
- Qualitatif
- Disponible en stock en trois finitions : métallique, laqué noir et laqué blanc











Aperçu

KG281	KG281	KG281	KB184	W4
perforations latérales	perforations latérales / opercules défonçables	complètement fermé	perforé	perforé
				

Caractéristiques

G.S.	✓	✓	✓	✓	✓
H.D.					✓
 Laqué	✓		✓		
 mm	70-600	70-330	70-330	100-600	50-400
 mm	60	60	60	60	15
L mm	3000	3000	3000	3000	3000 (B ≤ 250) 1960 (B ≥ 300)

Applications

 Tertiaire	✓	✓	✓	✓	✓
 Industrie				✓	✓
 Centres de données				✓	
 Installations PV				✓	✓
 Industrie alimentaire				✓	✓
 Pétrochimie				✓	✓
 G.S.	page 44	page 44	page 44	page 44	page 42
 H.D.	-	-	-	-	page 43
Laqué	page 44		page 44		

G.S. galvanisation Sendzimir NBN EN 10346 – recommandé dans les environnements corrosifs C2 (faible)
H.D. galvanisation à chaud NBN EN ISO 1461 – recommandé dans les environnements corrosifs C3/C4 (moyen/haut)
Laqué Galvanisation Sendzimir et pourvu d'un poudrage électrostatique en noir (RAL 9005) ou blanc (RAL 9010).
 Les autres couleurs RAL sur demande.







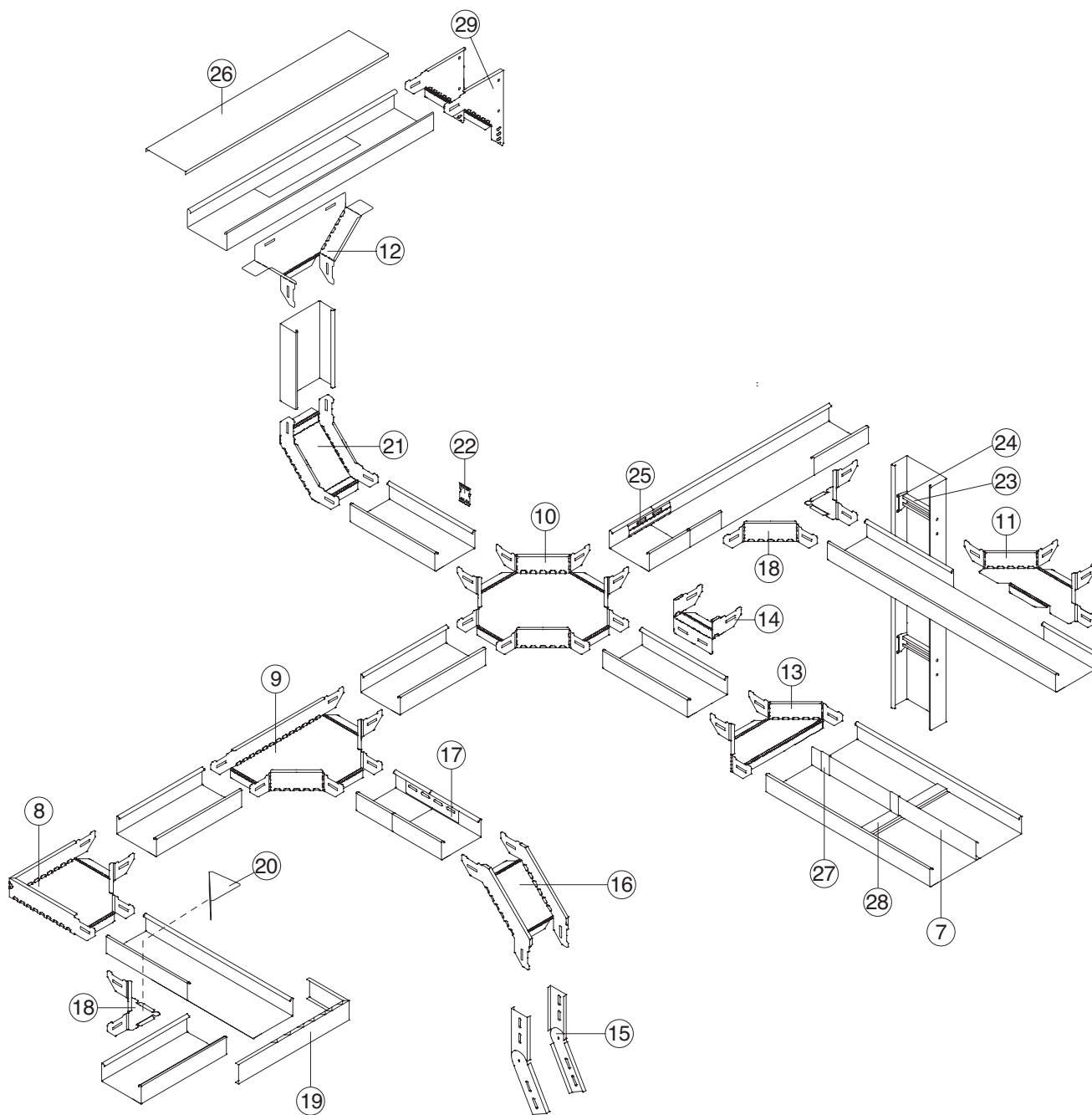
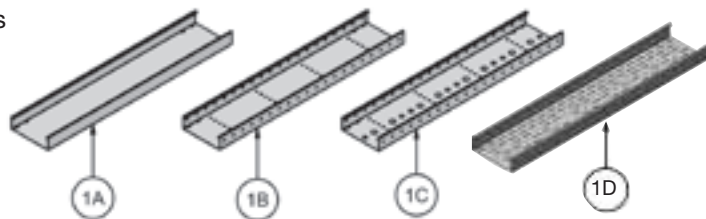

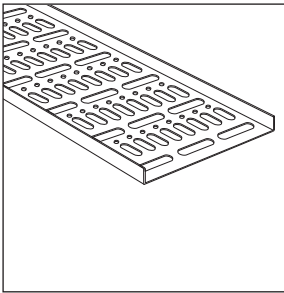

 voir page 4

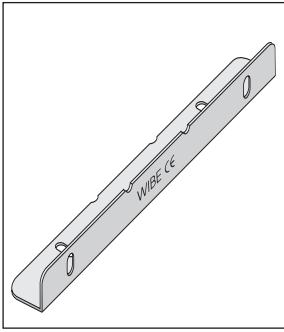

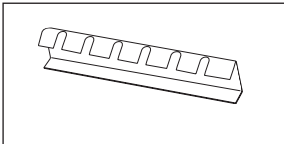



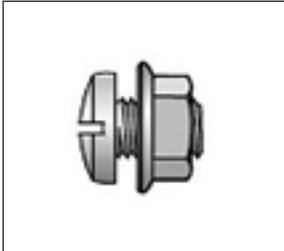

Vue d'ensemble

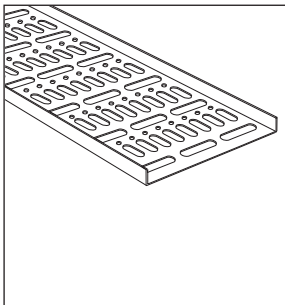
- 1A – Gaine à câbles KG 281 non perforée
- 1B – Gaine à câbles KG 281 avec perforations latérales
- 1C – Gaine à câbles KG 281 avec perforations latérales et opercules défonçables
- 1D – Chemin de câbles KB 184

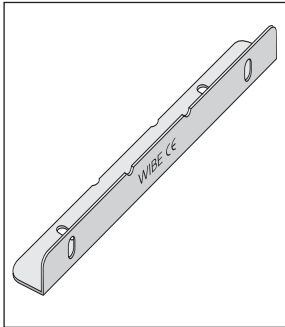

- | | | |
|---|--|-------------------------------------|
| 7 - Cloison de séparation | 16 - Raccord de descente | 23 - Echelon |
| 8 - Pièce d'angle | 17 - Accouplement | 24 - Fixation pour échelon |
| 9 - Pièce en T | 18 - Dérivation universelle | 25 - Accouplement sans vis |
| 10 - Croisillon | 19 - Accouplement / pièce de réduction | 26 - Couvercle |
| 11 - Dérivation | 20 - Couvercle pour dérivation universelle | 27 - Verrou pour cloison |
| 12 - Pièce murale verticale | 21 - Raccord de montée | 28 - Etrier de fond |
| 13 - Réduction | 22 - Fixation pour accessoire | 29 - Pièce en T verticale terminale |
| 14 - Dérivation surélevée | | |
| 15 - Raccord de descente: montée réglable | | |

	type	référence	 stock	page. catal.	groupe d'articles	prix en €
	Chemins de câbles W4					
	Acier galvanisé Sendzimir	50	735988	✓	46	10306 9,12/m
		75	735989	✓	46	10306 11,92/m
		100	735990	✓	46	10306 14,72/m
	↔ 3 m  6 m	150	735991	✓	46	10306 17,78/m
		200	735992	✓	46	10306 23,72/m
		250	735993		46	10306 30,74/m
	↔ 2 m	300	736609		46	10306 33,60/m
		400	736610		46	10306 41,86/m
		Accouplement W2				
Acier galvanisé Sendzimir			788572	✓	46	10306 5,70/pc.
	 10 pc.					
	Accouplement universel W4					
	Acier galvanisé Sendzimir		70510	✓	-	10306 2,88/pc.
	 20 pc.					
	Courbe 90° W4					
	Acier galvanisé Sendzimir	50	784073		46	10306 42,94/pc.
		75	784074		46	10306 45,41/pc.
		100	784075		46	10306 47,85/pc.
		150	784076		46	10306 53,98/pc.
		200	784077		46	10306 61,97/pc.
		250	784078		46	10306 69,32/pc.
	300	784079		46	10306 78,52/pc.	
	400	784080		46	10306 98,78/pc.	
	Pièce de montée/descente W4					
	Acier galvanisé Sendzimir	50	784089		47	10306 47,24/pc.
		75	784090		47	10306 51,52/pc.
		100	784091		47	10306 53,37/pc.
		150	784092		47	10306 60,76/pc.
		200	784093		47	10306 69,32/pc.
		250	784094		47	10306 77,30/pc.
		300	784095		47	10306 85,89/pc.
	400	784096		47	10306 100,61/pc.	
	Set de montage W34					
	Acier à zingage électrolytique	M6	718473	✓	58	10306 1,22/pc.
	 100 pc.					

	type	référence	stock	page. catal.	groupe d'articles	prix en €
	Chemins de câbles W4					
	Acier galvanisé à chaud	50	735977	✓	46	10306 12,35/m
		75	735978		46	10306 15,04/m
		100	735979	✓	46	10306 19,76/m
	↔ 3 m  6 m	150	735980		46	10306 24,44/m
		200	735981		46	10306 34,15/m
		250	735982		46	10306 43,46/m
	↔ 2 m	300	736619		46	10306 48,52/m
		400	736620		46	10306 59,33/m
		Accouplement W2				
Acier galvanisé à chaud			788573	✓	46	10306 6,75/pc.
	 10 pc.					
	Courbe 90° W4					
	Acier galvanisé à chaud	50	784081		46	10306 47,85/pc.
		75	784082		46	10306 50,30/pc.
		100	784083		46	10306 53,37/pc.
		150	784084		46	10306 62,57/pc.
		200	784085		46	10306 74,89/pc.
		250	784086		46	10306 79,14/pc.
		300	784087		46	10306 95,10/pc.
	400	784088		46	10306 115,95/pc.	
	Pièce de montée/descente W4					
	Acier galvanisé à chaud	50	784097		47	10306 52,15/pc.
		75	784098		47	10306 55,82/pc.
		100	784099		47	10306 58,28/pc.
		150	784100		47	10306 65,66/pc.
		200	784101		47	10306 76,08/pc.
		250	784102		47	10306 81,59/pc.
		300	784103		47	10306 93,25/pc.
	400	784104		47	10306 118,40/pc.	
	Set de montage W38P					
	Dacromet	M6	733258	✓	58	10306 1,47/pc.
	 100 pc.					



Gaine à câbles KG281 à parois latérales perforées H=60 mm, épaisseur 0,8 mm

type	référence	stock	page. catal.	groupe d'articles	prix en €	
Acier galvanisé Sendzimir ↔ 3 m  6 m	70	8601202	✓	24	10101	11,15/m
	120	8602202	✓	24	10101	12,48/m
	200	8603202	✓	24	10101	16,71/m
	250	8604202		24	10101	18,79/m

Gaine à câbles KG281 à parois latérales perforées H=60 mm, épaisseur 1 mm

Acier galvanisé Sendzimir ↔ 3 m  6 m	70	8601204	✓	24	10101	13,05/m
	120	8602204	✓	24	10101	15,52/m
	200	8603204	✓	24	10101	20,10/m
	250	8604204	✓	24	10101	24,09/m
	330	8605204	✓	24	10101	29,90/m
	400	8606204	✓	24	10101	36,23/m

Gaine à câbles KG281 à parois latérales perforées H=60 mm, épaisseur 1 mm

Acier galvanisé Sendzimir, laquage par poudrage blanc RAL 9010 ↔ 3 m	120	8602204UP9010N	-	10101	27,14/m
	200	8603204UP9010N	-	10101	35,20/m
	330	8605204UP9010N	-	10101	52,33/m

Gaine à câbles KG281 à parois latérales perforées H=60 mm, épaisseur 1 mm

Acier galvanisé Sendzimir, laquage par poudrage noir RAL 9005 ↔ 3 m	120	8602204UP9005N	✓	-	10101	27,14/m
	200	8603204UP9005N	✓	-	10101	35,20/m
	330	8605204UP9005N	✓	-	10101	52,33/m

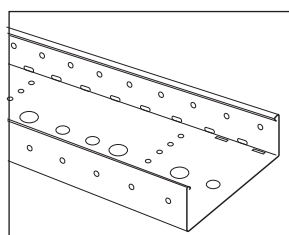

Gaine à câbles KG281 à parois latérales perforées et avec opercules défonçables H=60 mm, E=1mm

Acier galvanisé Sendzimir ↔ 3 m  6 m	70	8601004	✓	24	10101	13,70/m
	120	8602004	✓	24	10101	16,26/m
	200	8603004	✓	24	10101	21,12/m
	250	8604004	✓	24	10101	25,30/m
	330	8605004		24	10101	31,39/m

Gaine à câbles KG281 non perforée H=60mm, épaisseur 1 mm

Acier galvanisé Sendzimir ↔ 3 m  6 m	70	8601404	✓	24	10101	13,05/m
	120	8602404	✓	24	10101	15,52/m
	200	8603404	✓	24	10101	20,10/m
	250	8604404	✓	24	10101	24,09/m
	330	8605404	✓	24	10101	35,52/m

Gaine à câbles KG281 non perforée H=60mm, épaisseur 1 mm

Acier galvanisé Sendzimir, laquage par poudrage blanc RAL 9010 ↔ 3 m	120	8602404UP9010N	-	10101	27,14/m	
	200	8603404UP9010N	✓	-	10101	35,20/m
	330	8605404UP9010N	-	10101	62,17/m	

Gaine à câbles KG281 non perforée H=60mm, épaisseur 1 mm

Acier galvanisé Sendzimir, laquage par poudrage noir RAL 9005 ↔ 3 m	120	8602404UP9005N	✓	-	10101	27,14/m
	200	8603404UP9005N	✓	-	10101	35,20/m
	330	8605404UP9005N	✓	-	10101	62,17/m

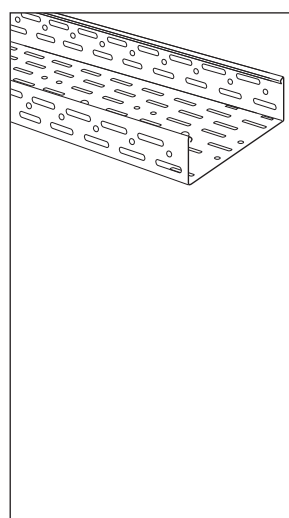

Chemin de câbles KB 184, H = 60 mm, épaisseur 1 mm

type	référence	stock	page. catal.	groupe d'articles	prix en €	
Acier galvanisé Sendzimir	100	76011004	✓	25	10102	14,78/m
↔ 3 m  6 m	150	76011504	✓	25	10102	17,54/m
	200	76012004	✓	25	10102	20,10/m
	250	76012504	✓	25	10102	24,09/m
	300	76013004	✓	25	10102	26,35/m
	400	76014004	✓	25	10102	34,21/m
	500	76015004	✓	25	10102	47,15/m
	600	76016004	✓	25	10102	54,30/m

Chemin de câbles KB 184, H = 60 mm, épaisseur 1,5 mm

Acier galvanisé Sendzimir	100	76011006		25	10102	27,05/m
↔ 3 m  6 m	200	76012006		25	10102	35,49/m
	300	76013006		25	10102	46,61/m
	400	76014006		25	10102	56,57/m
	500	76015006		25	10102	68,04/m
	600	76016006		25	10102	79,69/m



Accouplement

Acier galvanisé Sendzimir	200	80100	✓	26	10101	1,65/pc.
 10 pc.	Accouplement pour toutes épaisseurs.					



Unilock

Acier galvanisé Sendzimir		8010109	✓	26	10101	1,65/pc.
 10 pc.	Accouplement sans vis pour épaisseurs 0,8 mm et 1 mm.					



Raccord de descente et de montée, H = 60 mm

Acier galvanisé Sendzimir		8750000	✓	37	10122	12,20/set
 10 sets	Set pour les gaines à câbles KG281.					



Raccord de descente et de montée, H = 60 mm

Acier galvanisé Sendzimir		76120009	✓	37	10122	7,13/pc.
 20 pc.	Pour chemins de câbles KB 184.					



Cloison de séparation, H = 55 mm

Acier galvanisé Sendzimir		88701	✓	27	10101	6,57/m
↔ 3 m  30 m						















Verrou pour cloison de séparation

Acier galvanisé Sendzimir		88705	✓	27	10101	0,52/pc.
 50 pc.						









Etrier de fond

Acier galvanisé Sendzimir	70	88712		27	10101	6,13/pc.
	120	88722		27	10101	6,49/pc.
 10 pc.	200	88732		27	10101	7,01/pc.
	250	88742		27	10101	7,41/pc.
	330	88752		27	10101	8,47/pc.

	type	référence	 stock	page. catal.	groupe d'articles	prix en €
	Cloison de séparation, H = 55 mm					
	Acier galvanisé Sendzimir	760200	✓	28	10102	8,48/m
	↔ 3 m  30 m					
	Echelon					
	Acier galvanisé Sendzimir	70	81512		28	10101 sur demande
	 10 pc.	120	81522		28	10101 sur demande
		200	81532		28	10101 sur demande
		250	81542		28	10101 sur demande
		300	81550		28	10101 sur demande
		330	81552		28	10101 sur demande
		400	81562		28	10101 sur demande
500		81572		28	10101 sur demande	
600	81582		28	10101 sur demande		
	Fixation pour échelon					
	Acier galvanisé Sendzimir	81504		28	10101 sur demande	
	 24 pc.					
	Couvercle					
	Acier galvanisé Sendzimir	70	8161003	✓	29	10101 8,47/m
	↔ 2 m  4 m	100	8161103	✓	29	10101 10,99/m
		120	8162003	✓	29	10101 12,64/m
		150	8161503	✓	29	10101 14,27/m
		200	8163003	✓	29	10101 17,54/m
		250	8164003	✓	29	10101 20,31/m
		300	8164303	✓	29	10101 23,30/m
		330	8165004	✓	29	10101 31,63/m
		400	8166004	✓	29	10101 34,10/m
500		8167004		29	10101 39,62/m	
600	8168004		29	10101 54,58/m		
	Attache universelle					
	Acier inoxydable	88550	✓	29	10101	1,08/pc.
	 100 pc.					
	Attache extérieure					
	Acier inoxydable	H= 60mm 762400	✓	29	10101	2,13/pc.
	 20 pc.					
	Attache					
	Acier inoxydable	88520	✓	29	10101	1,28/pc.
	 100 pc.					

	type	référence	 stock	page. catal.	groupe d'articles	prix en €
	Plaque de montage universelle					
	Acier galvanisé Sendzimir	8090109	✓	30	10122	6,90/pc.
	 10 pc.					
	Plaque de montage plane					
	Acier galvanisé Sendzimir	8250109	✓	30	10122	6,37/pc.
	 10 pc.					
	Plaque de montage emboutie					
	Acier galvanisé Sendzimir	8250209	✓	30	10122	7,49/pc.
	 10 pc.					
	Ressort de serrage rapide pour plaque de montage					
	Acier inoxydable	88540		30	10122	0,39/pc.
	 100 pc.					
	Bande de protection					
	Matière synthétique/acier	8040000	✓	30	10122	63,93/pc.
	L = 5 m					
	Fixation pour accessoire					
	Acier inoxydable	8856050	✓	31	10122	1,21/pc.
	 20 pc.					

	type	référence	 stock	page. catal.	groupe d'articles	prix en €	
	Pièce d'angle, H = 60 mm						
	Acier galvanisé Sendzimir	70	36060702	✓	32	10122	25,80/pc.
		100	36061002	✓	32	10122	27,14/pc.
	Livrée sous forme aplanie.	120	36061202	✓	32	10122	27,73/pc.
		150	36061502	✓	32	10122	28,65/pc.
		200	36062002	✓	32	10122	30,76/pc.
		250	36062502	✓	32	10122	37,63/pc.
		300	36063002	✓	32	10122	45,52/pc.
		330	36063302	✓	32	10122	49,50/pc.
		400	36064002	✓	32	10122	58,80/pc.
		500	36065002		32	10122	74,31/pc.
	600	36066002		32	10122	94,71/pc.	
	Pièce d'angle, H = 60 mm						
	Acier galvanisé Sendzimir,	120	36061202UP9010N		-	10122	48,54/pc.
	laquage par poudrage blanc RAL 9010	200	36062002UP9010N	✓	-	10122	53,85/pc.
	330	36063302UP9010N		-	10122	86,63/pc.	
	Pièce d'angle, H = 60 mm						
	Acier galvanisé Sendzimir,	120	36061202UP9005N	✓	-	10122	48,54/pc.
	laquage par poudrage noir RAL 9005	200	36062002UP9005N	✓	-	10122	53,85/pc.
	330	36063302UP9005N	✓	-	10122	86,63/pc.	
	Couvercle pour pièce d'angle						
	Acier galvanisé Sendzimir	70	30060702	✓	32	10122	10,54/pc.
		100	30061002		32	10122	11,55/pc.
		120	30061202	✓	32	10122	12,64/pc.
		150	30061502		32	10122	15,04/pc.
		200	30062002	✓	32	10122	15,71/pc.
		250	30062502	✓	32	10122	18,47/pc.
		300	30063002		32	10122	25,65/pc.
		330	30063302		32	10122	26,45/pc.
		400	30064002		32	10122	34,35/pc.
		500	30065002		32	10122	47,96/pc.
		600	30066002		32	10122	69,57/pc.
	Pièce d'angle réglable, H = 60 mm						
	Acier galvanisé Sendzimir	70	36520702		32	10122	26,54/pc.
		100	36521002	✓	32	10122	29,30/pc.
	Livrée sous forme aplanie.	120	36521202	✓	32	10122	30,01/pc.
		150	36521502		32	10122	31,03/pc.
		200	36522002	✓	32	10122	32,46/pc.
		250	36522502		32	10122	36,45/pc.
		300	36523002		32	10122	38,32/pc.
		330	36523302		32	10122	57,04/pc.
		400	36524002		32	10122	100,71/pc.
		500	36525002		32	10122	142,00/pc.
	600	36526002		32	10122	166,04/pc.	



Pièce en T, H = 60 mm

	type	référence	stock	page. catal.	groupe d'articles	prix en €	
Acier galvanisé Sendzimir	70	36150702	✓	32	10122	34,69/pc.	
	100	36151002	✓	32	10122	37,59/pc.	
	Livrée sous forme aplanie.	120	36151202	✓	32	10122	39,68/pc.
		150	36151502	✓	32	10122	41,79/pc.
	200	36152002	✓	32	10122	45,69/pc.	
	250	36152502	✓	32	10122	54,20/pc.	
	300	36153002	✓	32	10122	62,70/pc.	
	330	36153302		32	10122	70,08/pc.	
	400	36154002		32	10122	87,39/pc.	
	500	36155002		32	10122	98,66/pc.	
600	36156002		32	10122	120,06/pc.		

Pièce en T, H = 60 mm

Acier galvanisé Sendzimir, laquage par poudrage blanc RAL 9010	120	36151202UP9010N	-	10122	69,43/pc.
	200	36152002UP9010N	-	10122	79,96/pc.
	330	36153302UP9010N	-	10122	122,64/pc.

Pièce en T, H = 60 mm

Acier galvanisé Sendzimir, laquage par poudrage noir RAL 9005	120	36151202UP9005N	-	10122	69,43/pc.
	200	36152002UP9005N	-	10122	79,96/pc.
	330	36153302UP9005N	-	10122	122,64/pc.

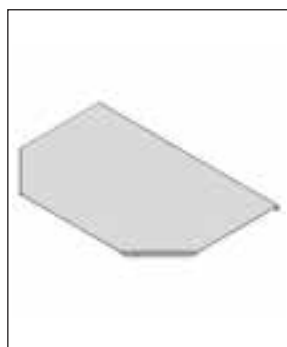

Couvercle pour pièce en T

Acier galvanisé Sendzimir	70	30150702	✓	33	10122	14,13/pc.
	100	30151002		33	10122	15,06/pc.
	120	30151202	✓	33	10122	16,52/pc.
	150	30151502		33	10122	16,93/pc.
	200	30152002	✓	33	10122	19,01/pc.
	250	30152502		33	10122	21,36/pc.
	300	30153002		33	10122	24,59/pc.
	330	30153302		33	10122	26,98/pc.
	400	30154002		33	10122	32,52/pc.
	500	30155002		33	10122	63,51/pc.
600	30156002		33	10122	77,56/pc.	



Croisillon, H = 60 mm







Acier galvanisé Sendzimir	70	36160702		33	10122	54,41/pc.	
	100	36161002		33	10122	55,38/pc.	
	Livrée sous forme aplanie.	120	36161202	✓	33	10122	56,02/pc.
		150	36161502		33	10122	56,93/pc.
	200	36162002	✓	33	10122	59,05/pc.	
	250	36162502		33	10122	69,12/pc.	
	300	36163002		33	10122	76,19/pc.	
	330	36163302		33	10122	100,07/pc.	
	400	36164002		33	10122	113,80/pc.	
	500	36165002		33	10122	134,14/pc.	
600	36166002		33	10122	164,39/pc.		

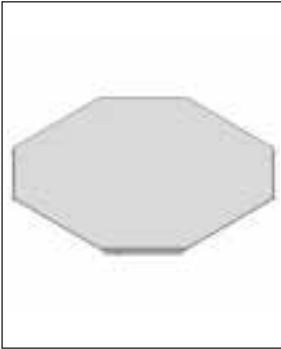

Croisillon, H = 60 mm

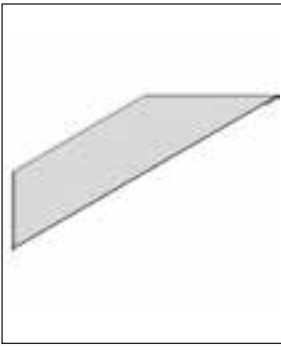



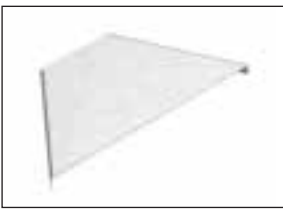

Acier galvanisé Sendzimir, laquage par poudrage blanc RAL 9010	120	36161202UP9010N	-	10122	98,03/pc.
	200	36162002UP9010N	-	10122	103,35/pc.
	330	36163302UP9010N	-	10122	153,07/pc.

Croisillon, H = 60 mm

Acier galvanisé Sendzimir, laquage par poudrage noir RAL 9005	120	36161202UP9005N	-	10122	98,03/pc.
	200	36162002UP9005N	-	10122	103,35/pc.
	330	36163302UP9005N	-	10122	153,07/pc.

	type	référence	 stock	page. catal.	groupe d'articles	prix en €	
	Couvercle pour croisillon						
	Acier galvanisé Sendzimir	70	30160702		33	10122	23,59/pc.
		100	30161002		33	10122	25,55/pc.
		120	30161202		33	10122	26,84/pc.
		150	30161502		33	10122	27,90/pc.
		200	30162002		33	10122	30,63/pc.
		250	30162502		33	10122	33,97/pc.
		300	30163002		33	10122	38,22/pc.
		330	30163302		33	10122	41,42/pc.
		400	30164002		33	10122	48,95/pc.
	500	30165002		33	10122	58,77/pc.	
	600	30166002		33	10122	70,52/pc.	
	Dérivation, H = 60 mm						
	Acier galvanisé Sendzimir	70	36070702	✓	33	10122	18,35/pc.
		100	36071002	✓	33	10122	19,54/pc.
	Livrée sous forme aplanie.	120	36071202	✓	33	10122	19,98/pc.
		150	36071502		33	10122	20,43/pc.
		200	36072002	✓	33	10122	22,14/pc.
		250	36072502	✓	33	10122	25,27/pc.
		300	36073002	✓	33	10122	36,15/pc.
		330	36073302	✓	33	10122	43,01/pc.
		400	36074002		33	10122	49,91/pc.
		500	36075002		33	10122	65,11/pc.
		600	36076002		33	10122	65,43/pc.
		Dérivation, H = 60 mm					
Acier galvanisé Sendzimir, laquage par poudrage blanc RAL 9010		120	36071202UP9010N		-	10122	34,99/pc.
		200	36072002UP9010N	✓	-	10122	38,74/pc.
	330	36073302UP9010N		-	10122	75,26/pc.	
	Dérivation, H = 60 mm						
	Acier galvanisé Sendzimir, laquage par poudrage noir RAL 9005	120	36071202UP9005N	✓	-	10122	34,99/pc.
		200	36072002UP9005N	✓	-	10122	38,74/pc.
	330	36073302UP9005N	✓	-	10122	75,26/pc.	
	Couvercle pour dérivation, H = 60 mm						
	Acier galvanisé Sendzimir	70	30070702	✓	34	10122	8,21/pc.
		100	30071002		34	10122	8,74/pc.
		120	30071202	✓	34	10122	10,37/pc.
		150	30071502		34	10122	11,97/pc.
		200	30072002	✓	34	10122	13,45/pc.
		250	30072502		34	10122	16,00/pc.
		300	30073002		34	10122	17,33/pc.
		330	30073302		34	10122	20,40/pc.
		400	30074002		34	10122	23,61/pc.
	500	30075002		34	10122	26,84/pc.	
	600	30076002		34	10122	33,10/pc.	
	Dérivation universelle, H = 60 mm						
	Acier galvanisé Sendzimir		36110002	✓	34	10122	7,94/pc.
	Livrée sous forme aplanie.						
	Couvercle pour dérivation universelle						
	Acier galvanisé Sendzimir		8980000	✓	34	10122	9,48/pc.

	type	référence	stock	page. catal.	groupe d'articles	prix en €	
	Dérivation surélevée, H = 60 mm						
	Acier galvanisé Sendzimir	70	36510702		35	10122	15,68/pc.
		100	36511002		35	10122	16,43/pc.
	Livrée sous forme aplanie.	120	36511202		35	10122	16,91/pc.
		150	36511502		35	10122	17,55/pc.
		200	36512002		35	10122	18,78/pc.
		250	36512502		35	10122	21,53/pc.
		300	36513002		35	10122	23,29/pc.
		330	36513302		35	10122	25,18/pc.
		400	36514002		35	10122	30,56/pc.
		Réduction, H = 60 mm					
	Acier galvanisé Sendzimir	70-120	36252202	✓	35	10122	22,57/pc.
		70-200	36252402		35	10122	29,68/pc.
	Livrée sous forme aplanie.	70-250	36252602		35	10122	30,71/pc.
		120-200	36254702	✓	35	10122	31,50/pc.
		120-250	36254802		35	10122	41,43/pc.
		200-250	36256402		35	10122	45,25/pc.
			Couvercle pour réduction				
Acier galvanisé Sendzimir			70-120	30252202	✓	35	10122
	70-200		30252402		35	10122	11,44/pc.
Livrée sous forme aplanie.	70-250		30252602		35	10122	14,35/pc.
	120-200		30254702	✓	35	10122	12,96/pc.
	120-250		30254802		35	10122	16,86/pc.
	200-250	30256402		35	10122	17,22/pc.	
	Accouplement / réduction, H = 60 mm						
	Acier galvanisé Sendzimir	605	8940000	✓	36	10122	9,12/pc.
Pour jonctions angulaires jusqu'à 330 mm.							
	Accouplement / réduction, H = 60 mm						
	Acier galvanisé Sendzimir	957	8960000	✓	36	10122	14,06/pc.
Pour jonctions angulaires jusqu'à 600 mm.							
	Raccord de montée, H = 60 mm						
	Acier galvanisé Sendzimir	70	36230702	✓	36	10122	20,15/pc.
		100	36231002	✓	36	10122	22,14/pc.
	Livré sous forme aplanie.	120	36231202	✓	36	10122	24,33/pc.
		150	36231502	✓	36	10122	26,49/pc.
		200	36232002	✓	36	10122	29,16/pc.
		250	36232502	✓	36	10122	36,86/pc.
		300	36233002	✓	36	10122	46,50/pc.
		330	36233302	✓	36	10122	51,18/pc.
		400	36234002		36	10122	62,00/pc.
		500	36235002		36	10122	74,92/pc.
		600	36236002		36	10122	81,17/pc.
Raccord de montée, H = 60 mm							
Acier galvanisé Sendzimir,	120	36231202UP9010N	-	10122	42,57/pc.		
laquage par poudrage	200	36232002UP9010N	-	10122	51,02/pc.		
blanc RAL 9010	330	36233302UP9010N	-	10122	89,58/pc.		
Raccord de montée, H = 60 mm							
Acier galvanisé Sendzimir,	120	36231202UP9005N	-	10122	42,57/pc.		
laquage par poudrage	200	36232002UP9005N	-	10122	51,02/pc.		
noir RAL 9005	330	36233302UP9005N	-	10122	89,58/pc.		

	type	référence	 stock	page. catal.	groupe d'articles	prix en €	
	Couvercle pour raccord de montée						
	Acier galvanisé Sendzimir	70	30230702	✓	36	10122	10,54/pc.
		100	30231002		36	10122	11,07/pc.
		120	30231202	✓	36	10122	12,25/pc.
		150	30231502		36	10122	14,26/pc.
		200	30232002		36	10122	15,71/pc.
		250	30232502		36	10122	19,84/pc.
		300	30233002		36	10122	23,59/pc.
		330	30233302		36	10122	24,59/pc.
		400	30234002		36	10122	31,03/pc.
		500	30235002		36	10122	37,08/pc.
	600	30236002		36	10122	47,65/pc.	
	Raccord de descente, H = 60 mm						
	Acier galvanisé Sendzimir	70	36220702	✓	37	10122	20,15/pc.
		100	36221002	✓	37	10122	22,14/pc.
	Livré sous forme aplanie.	120	36221202	✓	37	10122	24,33/pc.
		150	36221502	✓	37	10122	26,49/pc.
		200	36222002	✓	37	10122	29,16/pc.
		250	36222502	✓	37	10122	36,86/pc.
		300	36223002	✓	37	10122	46,50/pc.
		330	36223302		37	10122	51,18/pc.
		400	36224002		37	10122	62,00/pc.
		500	36225002		37	10122	74,92/pc.
		600	36226002		37	10122	81,17/pc.
		Raccord de descente, H = 60 mm					
Acier galvanisé Sendzimir, laquage par poudrage blanc RAL 9010		120	36221202UP9010N	-	10122	42,57/pc.	
		200	36222002UP9010N	-	10122	51,02/pc.	
	330	36223302UP9010N	-	10122	89,58/pc.		
	Raccord de descente, H = 60 mm						
	Acier galvanisé Sendzimir, laquage par poudrage noir RAL 9005	120	36221202UP9005N	-	10122	42,57/pc.	
		200	36222002UP9005N	-	10122	51,02/pc.	
	330	36223302UP9005N	-	10122	89,58/pc.		
	Couvercle pour raccord de descente, H = 60 mm						
	Acier galvanisé Sendzimir	70	30220702	✓	37	10122	10,54/pc.
		100	30221002		37	10122	11,30/pc.
		120	30221202	✓	37	10122	12,25/pc.
		150	30221502		37	10122	13,72/pc.
		200	30222002	✓	37	10122	15,71/pc.
		250	30222502		37	10122	19,84/pc.
		300	30223002		37	10122	22,27/pc.
		330	30223302		37	10122	24,59/pc.
		400	30224002		37	10122	31,03/pc.
		500	30225002		37	10122	37,08/pc.
		600	30226002		37	10122	47,65/pc.
		Pièce en T verticale terminale, H = 60 mm					
Acier galvanisé Sendzimir		70	36430702		37	10122	40,75/pc.
		100	36431002		37	10122	41,55/pc.
Livrée sous forme aplanie.		120	36431202	✓	37	10122	42,08/pc.
		150	36431502		37	10122	51,47/pc.
Pour la pièce en T verticale affichée, 2 pièces en T verticales terminales		200	36432002		37	10122	52,56/pc.
		250	36432502		37	10122	56,60/pc.
		300	36433002		37	10122	57,03/pc.
doivent être commandées.		330	36433302		37	10122	57,59/pc.
		400	36434002		37	10122	62,84/pc.
	500	36435002		37	10122	68,77/pc.	
	600	36436002		37	10122	71,73/pc.	



Pièce murale verticale avec couvercle, H = 60 mm

	type	référence	stock	page. catal.	groupe d'articles	prix en €
Acier galvanisé Sendzimir	70	36240702	✓	38	10122	67,15/pc.
	100	36241002		38	10122	67,49/pc.
Avec couvercle.	120	36241202	✓	38	10122	70,31/pc.
	150	36241502		38	10122	73,02/pc.
Livrée sous forme aplanie.	200	36242002		38	10122	76,57/pc.
	250	36242502		38	10122	88,16/pc.
	300	36243002		38	10122	100,89/pc.
	330	36243302		38	10122	112,92/pc.
	400	36244002		38	10122	123,61/pc.
	500	36245002		38	10122	167,50/pc.
	600	36246002		38	10122	205,20/pc.



Cloison terminale, H = 60 mm

Acier galvanisé Sendzimir	70	36180704	✓	38	10122	6,13/pc.
	100	36181004		38	10122	6,45/pc.
Livrée sous forme aplanie.	120	36181204	✓	38	10122	6,89/pc.
	150	36181504		38	10122	7,39/pc.
	200	36182004	✓	38	10122	7,70/pc.
	250	36182504		38	10122	8,29/pc.
	300	36183004		38	10122	9,42/pc.
	330	36183304		38	10122	10,10/pc.
	400	36184004		38	10122	10,94/pc.
	500	36185004		38	10122	13,04/pc.
	600	36186004		38	10122	15,20/pc.

Cloison terminale, H = 60 mm

Acier galvanisé Sendzimir, laquage par poudrage	120	36181204UP9010N	-	10122	12,05/pc.
	200	36182004UP9010N	-	10122	13,47/pc.
blanc RAL 9010	330	36183304UP9010N	-	10122	17,66/pc.

Cloison terminale, H = 60 mm

Acier galvanisé Sendzimir, laquage par poudrage	120	36181204UP9005N	-	10122	12,05/pc.
	200	36182004UP9005N	-	10122	13,47/pc.
noir RAL 9005	330	36183304UP9005N	-	10122	17,66/pc.

Vue d'ensemble

- | | |
|---|---|
| 1 - Gaine à câbles à parois latérales perforées | 9 - Fixation pour accessoire |
| 2 - Gaine à câbles avec opercules défonçables | 11 - Dispositif de verrouillage |
| 3 - Gaine à câbles non perforées | 12 - Cloison de séparation |
| 4 - Plaque de montage universelle | 13 - Accouplement |
| 5 - Echelon | 14 - Etrier de fond |
| 6 - Fixation pour échelon | 15 - Attache couvercle |
| 7 - Plaque de montage emboutie | 16 - Couvercle |
| 8 - Accouplement sans vis | 17 - Attache universelle pour couvercle |
| | 18 - Attache extérieure pour couvercle |

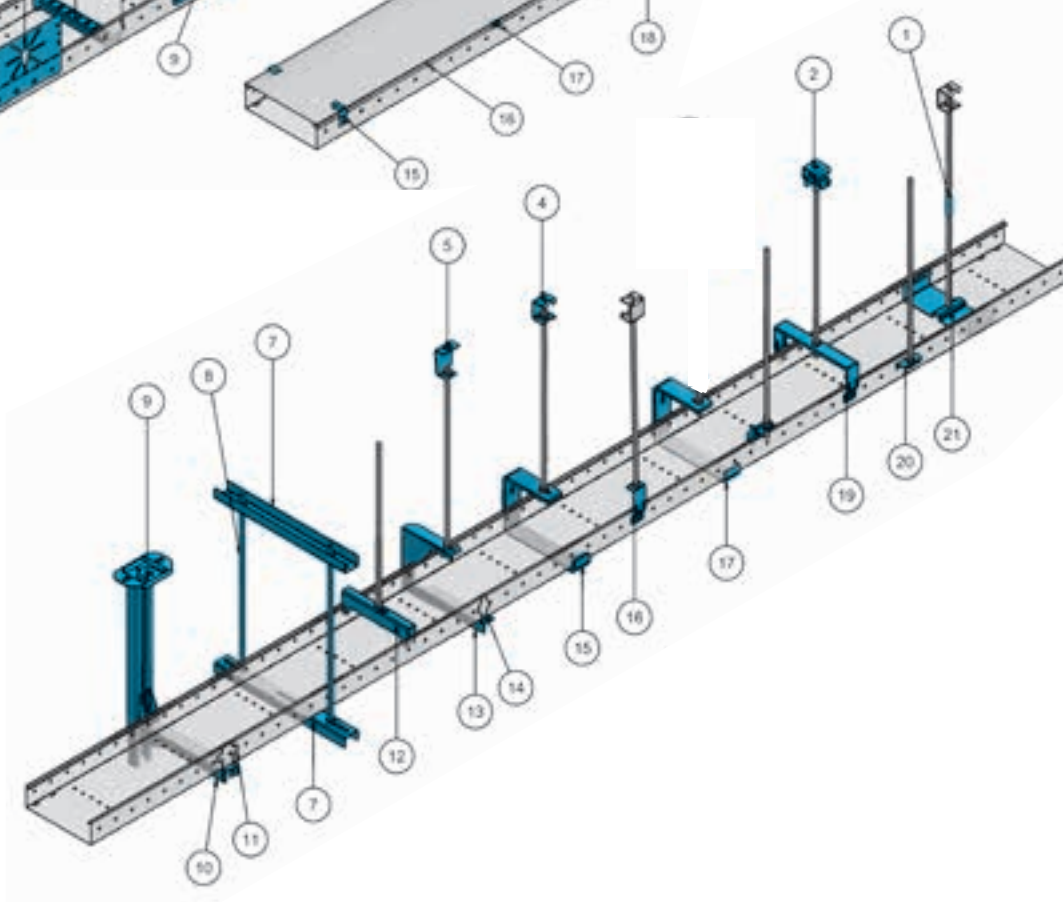
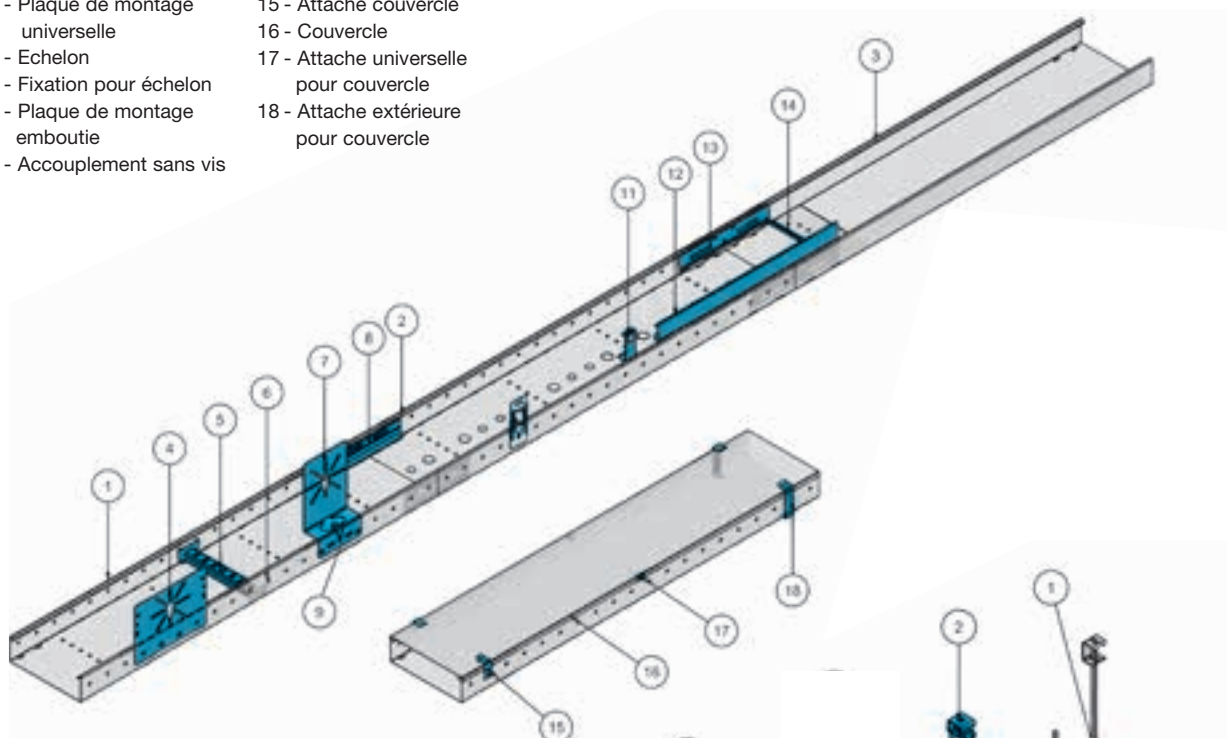











- | | | |
|------------------------------|----------------------------|---|
| 1 - Ecrou de rallonge | 10 - Console 50i | |
| 2 - Etrier de plafond | 11 - Ressort | |
| 4 - Etrier de plafond ouvert | 12 - Etrier supérieur | |
| 5 - Etrier de plafond | 13 - Etrier en C extérieur | 19 - Etrier supérieur pour porteur de câbles avec couvercle |
| 7 - Profilé de support | 14 - Ressort | |
| 8 - Tige filetée M10 | 15 - Etrier en C | 20 - Etrier pour perforation latérale |
| 9 - Pendard 2F | 16 - Etrier de suspension | |
| | 17 - Etrier en C | 21 - Etrier intérieur |

Systemes de suspension – gaines et chemins de câbles

	type	référence	stock	page. catal.	groupe d'articles	prix en €
	Etrier supérieur					
	Acier galvanisé Sendzimir	70	8101009	✓	49	10127 4,49/pc.
	 30 pc.	120	8112009	✓	49	10127 5,44/pc.
		200	8123009		49	10127 7,73/pc.
	 20 pc.	250	8134009		49	10127 8,74/pc.
	330	8135009		49	10127 11,53/pc.	
	Etrier supérieur					
	Acier galvanisé Sendzimir	70	86510		49	10127 13,82/pc.
	 25 pc.	120	86520		49	10127 16,23/pc.
	 10 pc.	200	86530		49	10127 18,33/pc.
	250	86540		49	10127 19,84/pc.	
	Etrier intérieur avec écrou M10					
	Acier galvanisé Sendzimir	70	8140709	✓	49	10127 7,62/pc.
	 5 pc.	100	8141009	✓	49	10127 8,54/pc.
		120	8141209	✓	49	10127 9,32/pc.
		150	8141509	✓	49	10127 10,16/pc.
		200	8142009	✓	49	10127 11,29/pc.
		250	8142509	✓	49	10127 13,39/pc.
		300	8143009	✓	49	10127 15,02/pc.
	330	8143309	✓	49	10127 16,19/pc.	
	Etrier en C extérieur					
	Acier galvanisé Sendzimir	70	81710	✓	50	10127 15,89/pc.
	 10 pc.	120	81720	✓	50	10127 17,44/pc.
		200	81730	✓	50	10127 23,61/pc.
		250	81740		50	10127 28,20/pc.
Deux pièces ressorts 84400 à commander séparément.						
	Ressort					
	Acier inoxydable		84400		50	10127 1,54/pc.
 25 pc.						
	Etrier en C					
	Acier galvanisé Sendzimir	70	CEZ070	✓	50	10504 7,95/pc.
	 10 pc.	100	CEZ100	✓	50	10504 8,53/pc.
		120	CEZ120	✓	50	10504 8,90/pc.
		150	CEZ150	✓	50	10504 12,24/pc.
	 6 pc.	200	CEZ200	✓	50	10504 13,61/pc.
		300	CEZ300	✓	50	10504 21,01/pc.
		400	CEZ400	✓	50	10504 27,48/pc.
	Etrier en C					
	Acier galvanisé à chaud	70	81712	✓	-	10127 11,53/pc.
	 20 pc.	100	81731	✓	-	10127 12,28/pc.
		120	81722	✓	-	10127 13,86/pc.
		150	81715	✓	-	10127 16,23/pc.
		200	81732	✓	-	10127 17,94/pc.
	 15 pc.	250	81742	✓	-	10127 24,24/pc.
		300	81733	✓	-	10127 26,87/pc.
	 10 pc.	330	81752	✓	-	10127 31,66/pc.
		400	81762	✓	-	10127 40,37/pc.

Systemes de suspension – gaines et chemins de câbles

	type	référence	 stock	page. catal.	groupe d'articles	prix en €
	Pendant simple 2F					
	Acier galvanisé à chaud	2F/ 280	717196	✓	51	10313 22,79/pc.
		2F/ 370	717197	✓	51	10313 26,04/pc.
		2F/ 505	717198	✓	51	10313 29,56/pc.
		2F/ 730	717199	✓	51	10313 33,93/pc.
		2F/ 1000	717200	✓	51	10313 38,97/pc.
	2F/ 1500	787276	✓	51	10313 113,17/pc.	
	Pendant double 20					
	Acier galvanisé à chaud	20/ 505	715723	✓	51	10313 70,78/pc.
		20/ 730	715724	✓	51	10313 86,09/pc.
		20/ 1000	715725	✓	51	10313 109,04/pc.
		20/ 1500	715726	✓	51	10313 142,33/pc.
		20/ 2000	715727	✓	51	10313 178,83/pc.
	20/ 3000	715728	✓	51	10313 296,12/pc.	
	Console 50i					
	Acier galvanisé Sendzimir	50i/ 100	791412	✓	52	10304 4,50/pc.
		50i/ 200	791413	✓	52	10304 6,27/pc.
		50i/ 300	791414	✓	52	10304 7,61/pc.
		50i/ 400	791415	✓	52	10304 12,32/pc.
		50i/ 500	795322	✓	-	10304 19,16/pc.
	50i/ 600	795323	✓	-	10304 21,76/pc.	
	Console 50i					
	Acier galvanisé à chaud	50i/ 100	795316	✓	-	10304 8,17/pc.
		50i/ 200	795317	✓	-	10304 9,23/pc.
		50i/ 300	795318	✓	-	10304 13,51/pc.
		50i/ 400	795319	✓	-	10304 15,34/pc.
		50i/ 500	795320	✓	-	10304 20,90/pc.
	50i/ 600	795321	✓	-	10304 23,59/pc.	
	Console 50i					
	Acier galvanisé Sendzimir, laquage par poudrage blanc RAL 9010	50i/ 100	791416	-	10304	21,16/pc.
		50i/ 200	791417	-	10304	26,27/pc.
		50i/ 300	791418	-	10304	30,09/pc.
		50i/ 400	791419	-	10304	46,58/pc.
		50i/ 500	795363	-	10304	51,65/pc.
	50i/ 600	795364	-	10304	56,19/pc.	
	Console murale ou plaque murale					
Acier galvanisé Sendzimir	70	80610	✓	53	10127 12,25/pc.	
 20 pc.						
Deux ressorts 84901 à commander séparément.						
	Profilé de suspension pour console					
	Acier galvanisé Sendzimir	100	40611	-	53	10127 2,52/pc.
	 20 pc.	120	80602	✓	53	10127 2,85/pc.
		150	40616	-	53	10127 3,37/pc.
		200	80603	✓	53	10127 4,61/pc.
	Apte à ressort 84901.	250	80604	✓	53	10127 5,64/pc.
		300	40631	✓	53	10127 7,28/pc.
		330	80605	-	53	10127 9,42/pc.
		400	80606	✓	53	10127 11,94/pc.
		500	80607	-	53	10127 18,53/pc.

Systemes de suspension – gaines et chemins de câbles

	type	référence	stock	page. catal.	groupe d'articles	prix en €
	Ressort					
	Acier inoxydable	84901	✓	-	10127	1,88/pc.
	 25 pc. Deux pièces par profilé de suspension.					
	Etrier de serrage					
	Acier galvanisé Sendzimir M10	81501		53	10127	3,37/pc.
	 50 pc.					
	Etrier de serrage					
	Acier galvanisé Sendzimir M10	81503		52	10127	4,11/pc.
	 50 pc.					
	Etrier de plafond					
	Acier galvanisé Sendzimir M10	80200	✓	52	10127	4,49/pc.
	Etrier de plafond, ouvert					
	Acier galvanisé à chaud M10	80202	✓	53	10127	3,69/pc.
	Etrier de plafond, réglable					
	Acier galvanisé à chaud M10	80201	✓	53	10127	8,65/pc.
	Equerre W8					
	Acier galvanisé Sendzimir W8	716821	✓	49	10306	5,18/pc.
	 10 pc.					
	Equerre W8					
	Acier galvanisé à chaud W8	728883		49	10306	8,69/pc.
	 10 pc.					

Systemes de suspension – gaines et chemins de câbles

	type	référence	stock	page. catal.	groupe d'articles	prix en €	
	Vis crénelée						
	Acier à zingage électrolytique	M6x10	08462000	✓	57	10127	0,23/pc.
	 100 pc.						
	Vis crénelée						
	Acier galvanisé à chaud	M6x10	08462020	✓	-	10127	0,25/pc.
	 100 pc.						
	Ecroû 6 pans à embase crénelée						
	Acier à zingage électrolytique	M6	08461000	✓	57	10127	0,21/pc.
	 100 pc.	M10	08890100	-	10127	0,59/pc.	
	Ecroû 6 pans à embase crénelée						
	Acier galvanisé à chaud	M6	08461020	✓	-	10127	0,26/pc.
	 100 pc.						
	Ecroû hexagonal						
	Acier à zingage électrolytique	M6	08180000	✓	57	10127	0,15/pc.
		M8	08891000	✓	57	10127	0,18/pc.
	 100 pc.	M10	08890000	✓	57	10127	0,21/pc.
	Rondelle						
	Acier à zingage électrolytique	M6	08190000	✓	57	10127	0,05/pc.
		M8	08901000	✓	57	10127	0,08/pc.
	 100 pc.	M10	08900000	✓	57	10127	0,21/pc.
	Rondelle						
	Acier galvanisé à chaud	M6	08190020	-	-	10127	0,21/pc.
	 100 pc.						
	Rondelle carrosserie						
	Acier à zingage électrolytique	M6	81977	✓	57	10127	0,08/pc.
		M8	89077	✓	57	10127	0,15/pc.
	 200 pc.	M10	89177	✓	57	10127	0,24/pc.
	Tige filetée						
	Acier à zingage électrolytique	M6	08050200	✓	58	10127	2,78/m
		M8	08051000	✓	58	10127	4,21/m
	 50 m ↔ 2 m	M10	08050000	✓	58	10127	5,00/m
	Tige filetée						
	Acier à zingage électrolytique	M10	08050100	✓	-	10127	5,00/m
	 50 m ↔ 3 m						
	Tige filetée						
	Acier galvanisé à chaud	M10	08051020	-	-	10127	16,53/m
	 50 m ↔ 1 m						
	Ecroû de rallonge hexagonal						
	Acier à zingage électrolytique	M8x24	725083	-	58	10313	3,67/pc.
	 10 pc.	M10x30	724806	✓	58	10313	5,12/pc.

NEW

gaines à câbles
fermées inducanal®chemins de câbles
perforés pemsaband®

inducanal® gaines à câbles fermées (N)

pemsaband® chemins de câbles perforés (N)



Système de raccordement Click

Le système de raccordement unique est pourvu de languettes, ce qui augmente la facilité de raccordement des longueurs et réduit considérablement la durée d'installation. Ainsi, les plaques d'accouplement deviennent superflues lors du montage de tracés droits. Deux boulons à collet et écrous à embase crénelée suffisent pour fixer le raccordement.

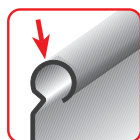

Sûr

Le rebord de sécurité offre une rigidité supplémentaire et permet d'éviter les blessures et l'endommagement du câblage.

Rebord fini

Grâce au rebord fini un couvercle PEMSA approprié peut être encliqueté sans matériel de fixation supplémentaire. Même dans le cas d'un montage vertical, le couvercle reste en place.

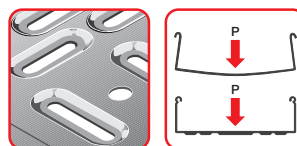

Rigide

La base profilée augmente considérablement la résistance

longitudinale et transversale. Les gaines à câbles en deviennent extrêmement solides avec une capacité élevée en comparaison d'un chemin de câbles sans relief.



Pemsaband LX & SX avec double rangée de perforations

Cela permet d'attacher les câbles au parois latérales d'une manière encore plus efficace et plus simple.

pemsaband®			inducanal®	
click SX	click LX	INOX	click fermé	INOX fermé



Caractéristiques					
G.S.	✓	✓		✓	
H.D.	✓	✓		✓	
INOX 304			✓		✓
◀ mm	100-600	100-600	100-600	60-600	60-600
↕ mm	60/85 (click) 100 (non-click)	35/60/85 (click) 100 (non-click)	60	35/60/85 (click) 100 (non-click)	60
L mm	3000	3000	3000	3000	3000
🌡	-50 °C / +150 °C				
⬇ N/m					
📦	20 J.				
🔥	E60				
Applications					
🏢 Tertiaire	✓	✓		✓	
🚶 Tunnels	✓	✓		✓	
📶 Centres de données	✓	✓		✓	
⚙ Installations PV	✓	✓			
🌿 Industrie alimentaire	✓	✓	✓	✓	✓
🏭 Pétrochimie	✓	✓	✓	✓	✓
📖 G.S.	page 61	page 61	-	page 62	-
📖 H.D.	page 74	page 74	-	page 71	-
📖 INOX 304	-	-	page 80	-	page 80

G.S. galvanisation Sendzimir NBN EN 10346 – recommandé dans les environnements corrosifs C2 (faible)
H.D. galvanisation à chaud NBN EN ISO 1461 – recommandé dans les environnements corrosifs C3/C4 (moyen/haut)
INOX 304 acier inoxydable AISI 304 – recommandé dans les environnements corrosifs C5-I (très haut – industrie)





Chemin de câbles Pemsaband LX Click, H = 35 mm

Acier galvanisé Sendzimir

type	référence	stock	page. catal.	groupe d'articles	prix en €
↔ 3 m  24 m	35x100 75821100	✓	092	20308	8,55/m
 12 m	35x150 75821150	✓	092	20308	10,62/m
	35x200 75821200		092	20308	14,06/m
	35x300 75821300	✓	092	20308	18,62/m
 6 m	35x400 75821400		092	20308	27,92/m



Chemin de câbles Pemsaband LX Click, H = 60 mm

Acier galvanisé Sendzimir

↔ 3 m  24 m	60x060 75822060		092	20310	sur demande
	60x100 75822100	✓	092	20310	9,01/m
 12 m	60x150 75822150	✓	092	20310	11,88/m
	60x200 75822200	✓	092	20310	13,43/m
 6 m	60x300 75822300	✓	092	20310	17,49/m
	60x400 75822400	✓	092	20310	21,88/m
	60x500 75822500	✓	092	20310	30,68/m
	60x600 75822600	✓	092	20310	35,93/m

Chemin de câbles Pemsaband SX Click, H = 60 mm

Acier galvanisé Sendzimir

↔ 3 m  24 m	60x100 75522100	✓	093	20308	10,44/m
	 12 m	60x150 75522150	✓	093	20308
60x200 75522200		✓	093	20308	15,11/m
 6 m	60x300 75522300	✓	093	20308	20,12/m
	60x400 75522400	✓	093	20308	29,07/m
	60x500 75522500	✓	093	20308	34,12/m
	60x600 75522600	✓	093	20308	40,06/m

Chemin de câbles Pemsaband LX Click, H = 85 mm

Acier galvanisé Sendzimir

↔ 3 m	85x200 75223200		092	20308	19,74/m
	85x300 75223300		092	20308	24,94/m
	85x400 75223400		092	20308	36,75/m
	85x500 75223500		092	20308	43,25/m
	85x600 75223600		092	20308	50,93/m

Chemin de câbles Pemsaband LX, H = 100 mm

Acier galvanisé Sendzimir

↔ 3 m	100x100 75224100		092	20308	16,05/m
	100x200 75224200		092	20308	21,25/m
	100x300 75224300		092	20308	26,45/m
	100x400 75224400		092	20308	39,18/m
	100x500 75224500		092	20308	45,11/m
	100x600 75224600		092	20308	54,00/m

Accouplement Rejiband-Pemsaband

Acier galvanisé Sendzimir



 1 set	60	70120200		106	20309	21,99/set
---	----	----------	--	-----	-------	-----------







Gaine à câbles Inducanal Click, H= 35 mm

Acier galvanisé Sendzimir

type	référence	stock	page. catal.	groupe d'articles	prix en €
↔ 3 m  24 m	35x100 75121100		095	20311	8,55/m
 12 m	35x150 75121150		095	20311	10,62/m
	35x200 75121200		095	20311	14,06/m
	35x300 75121300		095	20311	18,62/m

Gaine à câbles Inducanal Click, H= 60 mm

Acier galvanisé Sendzimir

↔ 3 m  24 m	60x060 75122060	✓	095	20311	10,44/m
	60x100 75122100	✓	095	20311	10,44/m
 12 m	60x150 75122150	✓	095	20311	13,94/m
	60x200 75122200	✓	095	20311	15,11/m
 6 m	60x300 75122300	✓	095	20311	20,12/m
	60x400 75122400		095	20311	29,07/m
	60x500 75122500		095	20311	34,12/m
	60x600 75122600		095	20311	54,18/m

Gaine à câbles Inducanal Click, H= 85 mm

Acier galvanisé Sendzimir

↔ 3 m	85x200 75423200		095	20311	22,45/m
	85x300 75423300		095	20311	29,81/m
	85x400 75423400		095	20311	42,37/m
	85x500 75423500		095	20311	49,36/m
	85x600 75423600		095	20311	55,80/m

Gaine à câbles Inducanal, H = 100 mm

Acier galvanisé Sendzimir

↔ 3 m	100x100 75424100		095	20311	20,83/m
	100x200 75424200		095	20311	24,18/m
	100x300 75424300		095	20311	32,18/m
	100x400 75424400		095	20311	44,55/m
	100x500 75424500		095	20311	51,36/m
	100x600 75424600		095	20311	68,55/m

Boulon à collet carré et écrou 6 pans à embase crénelée

Acier à zingage électrolytique

 100 pc.

M6X12	67010093	✓	100	20309	0,36/pc.
-------	----------	---	-----	-------	----------

Boulon à collet carré

Acier à zingage électrolytique

 100 pc.











M6x12	67010099	✓	174	20309	0,27/pc.
M6x20	67010100	✓	174	20309	0,30/pc.

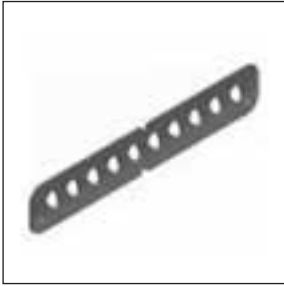
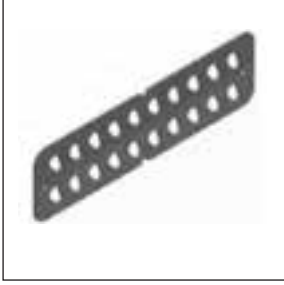
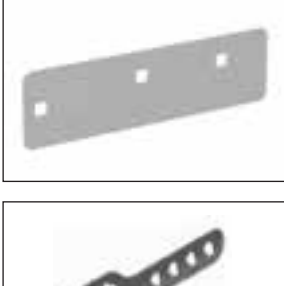

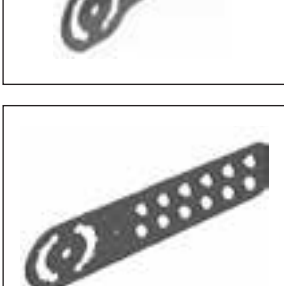

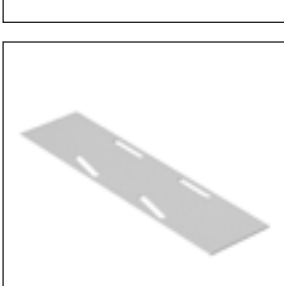

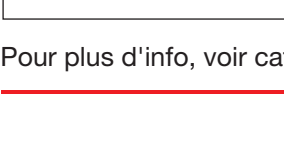

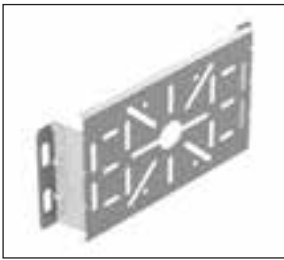

Écrou 6 pans à embase crénelée



Acier à zingage électrolytique





 50 pc.



M6	64010059	✓	174	20309	0,21/pc.
----	----------	---	-----	-------	----------

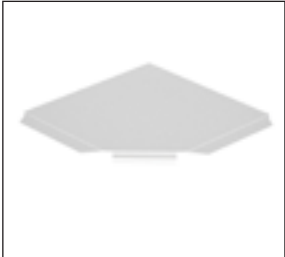

	type	référence	 stock	page. catal.	groupe d'articles	prix en €	
	Accouplement						
	Acier galvanisé Sendzimir	35	71021005	✓	100	20309	1,50/pc.
	Accouplement						
	Acier galvanisé Sendzimir	60	93910002	✓	66	20309	2,19/pc.
	Accouplement						
	Acier galvanisé Sendzimir	85/100	93910003		66	20309	3,95/pc.
	Plaque pour pièce de montée/descente						
	Acier galvanisé Sendzimir	35	71021006	✓	100	20309	1,24/pc.
	 4 pc.	4 plaques pour 1 pièce de montée/descente.					
	Plaque pour pièce de montée/descente						
	Acier galvanisé Sendzimir	60	93910012	✓	66	20309	2,31/pc.
	 8 pc.	4 plaques pour 1 pièce de montée/descente.					
	Plaque pour pièce de montée/descente						
	Acier galvanisé Sendzimir	85/100	93910013		66	20309	3,89/pc.
	 8 pc.	4 plaques pour 1 pièce de montée/descente.					
	Accouplement de fond						
	Acier galvanisé Sendzimir	300	71020300		100	20309	8,45/pc.
		400	71020400		100	20309	9,80/pc.
		500	71020500		100	20309	10,99/pc.
		600	71020600		100	20309	13,25/pc.
	 10 pc.						



	type	référence	 stock	page. catal.	groupe d'articles	prix en €		
	Plaque de montage Pemsaband							
	Acier galvanisé Sendzimir	60	70420911	✓	104	20309	6,31/pc.	
	 10 pc.							
	Bande de protection							
	Caoutchouc/adhésif		71000000	✓	104	20309	7,19/m	
	 25 m							
	Borne de terre							
	Laiton	16-50 mm ²	68000034	✓	106	20309	6,11/pc.	
	 20 pc.	50-110 mm ²	68000035		106	20309	12,27/pc.	
	Couvercle Click							
	Acier galvanisé Sendzimir							
	↔ 3 m	 24 m	60	73021060	✓	102	20316	7,27/m
			100	73021100	✓	102	20316	9,39/m
		 12 m	150	73021150	✓	102	20316	12,17/m
			200	73021200	✓	102	20316	14,82/m
		 6 m	300	73021300	✓	102	20316	22,59/m
		400	73021400		102	20316	28,94/m	
		500	73021500		102	20316	39,21/m	
		600	73021600		102	20316	46,01/m	
	Cloison de séparation							
	Acier galvanisé Sendzimir							
	↔ 3 m	 60 m	25	67020610	✓	104	20316	7,24/m
		 48 m	50	67020611	✓	104	20316	8,14/m
	 36 m	80	67020612		104	20316	14,31/m	
	Plaque d'identification							
	Matière synthétique		68000020		034	20307	1,21/pc.	
	 50 pc.							

	type	référence	stock	page. catal.	groupe d'articles	prix en €	
Courbe réglable							
	Acier galvanisé Sendzimir	35x100		116	20309	37,24/pc.	
		35x150		116	20309	39,26/pc.	
	Livrée sous forme aplanie.	35x200	70028120		116	20309	45,73/pc.
		35x300	70028130		116	20309	51,31/pc.
		60x100	70028210	✓	116	20309	37,81/pc.
		60x150	70028215		116	20309	40,12/pc.
		60x200	70028220	✓	116	20309	46,50/pc.
		60x300	70028230	✓	116	20309	52,43/pc.
	Embout et réduction						
		Acier galvanisé Sendzimir	35x100		116	20309	23,63/pc.
		35x150	71021015		116	20309	30,51/pc.
Livrée sous forme aplanie.		35x200	71021020		116	20309	32,44/pc.
		35x300	71021030		116	20309	43,8/pc.
		60x100	71022010	✓	116	20309	25,12/pc.
		60x150	71022015		116	20309	32,86/pc.
		60x200	71022020		116	20309	37,07/pc.
		60x300	71022030		116	20309	48,37/pc.
		60x400	71022040		116	20309	61,40/pc.
		60x500	71022050		116	20309	75,19/pc.
		60x600	71022060		116	20309	90,02/pc.
		85x200	71023020		116	20309	45,68/pc.
		85x300	71023030		116	20309	57,83/pc.
		85x400	71023040		116	20309	66,21/pc.
		85x500	71023050		116	20309	79,84/pc.
		85x600	71023060		116	20309	93,58/pc.
		100x100	71024010		116	20309	24,17/pc.
		100x200	71024020		116	20309	42,72/pc.
		100x300	71024030		116	20309	60,05/pc.
		100x400	71024040		116	20309	70,34/pc.
	100x500	71024050		116	20309	82,30/pc.	
	100x600	71024060		116	20309	96,73/pc.	
Courbe Click 90°							
	Acier galvanisé Sendzimir	35x100		108	20309	26,24/pc.	
		35x150	70020115		108	20309	29,30/pc.
	Livrée sous forme aplanie.	35x200	70020120		108	20309	33,56/pc.
		35x300	70020130		108	20309	38,94/pc.
		60x060	70020206		108	20309	25,05/pc.
		60x100	70020210	✓	108	20309	25,05/pc.
		60x150	70020215	✓	108	20309	26,88/pc.
		60x200	70020220	✓	108	20309	28,85/pc.
		60x300	70020230	✓	108	20309	42,69/pc.
		60x400	70020240	✓	108	20309	55,16/pc.
		60x500	70020250	✓	108	20309	63,58/pc.
		60x600	70020260	✓	108	20309	83,32/pc.
		85x200	70020320		108	20309	39,43/pc.
		85x300	70020330		108	20309	50,88/pc.
		85x400	70020340		108	20309	110,50/pc.
		85x500	70020350		108	20309	134,17/pc.
		85x600	70020360		108	20309	138,49/pc.
		100x100	70020410		108	20309	52,13/pc.
		100x200	70020420		108	20309	56,31/pc.
		100x300	70020430		108	20309	85,43/pc.
	100x400	70020440		108	20309	119,44/pc.	
	100x500	70020450		108	20309	150,25/pc.	
	100x600	70020460		108	20309	175,24/pc.	

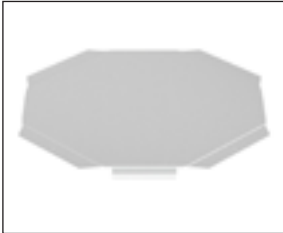







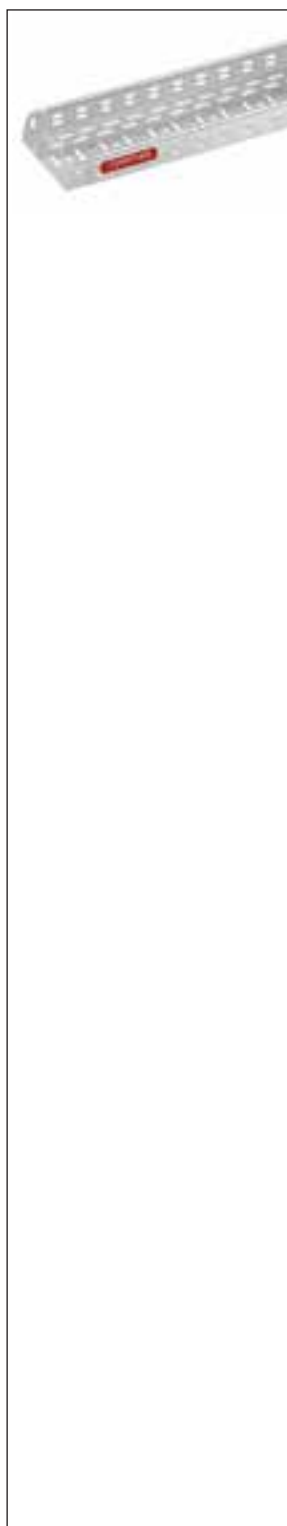



	type	référence	 stock	page. catal.	groupe d'articles	prix en €	
	Couvercle pour courbe Click 90°						
	Acier galvanisé Sendzimir	60	73020060		108	20309	21,88/pc.
		100	73020100	✓	108	20309	21,88/pc.
		150	73020150	✓	108	20309	25,00/pc.
		200	73020200	✓	108	20309	28,00/pc.
		300	73020300		108	20309	37,24/pc.
		400	73020400		108	20309	68,68/pc.
		500	73020500		108	20309	86,49/pc.
	600	73020600		108	20309	98,80/pc.	
	Pièce en T Click						
	Acier galvanisé Sendzimir	35x100	70022110		109	20309	34,74/pc.
		35x150	70022115		109	20309	38,81/pc.
	Livrée sous forme aplanie.	35x200	70022120		109	20309	44,49/pc.
		35x300	70022130		109	20309	51,55/pc.
		60x100	70022210	✓	109	20309	36,19/pc.
		60x150	70022215	✓	109	20309	40,56/pc.
		60x200	70022220	✓	109	20309	46,36/pc.
		60x300	70022230	✓	109	20309	53,55/pc.
		60x400	70022240		109	20309	99,74/pc.
		60x500	70022250		109	20309	143,18/pc.
		60x600	70022260		109	20309	163,63/pc.
		85x200	70022320		109	20309	52,19/pc.
		85x300	70022330		109	20309	67,13/pc.
		85x400	70022340		109	20309	119,35/pc.
		85x500	70022350		109	20309	139,62/pc.
		85x600	70022360		109	20309	177,55/pc.
		100x100	70022410		109	20309	52,42/pc.
		100x200	70022420		109	20309	73,94/pc.
		100x300	70022430		109	20309	106,86/pc.
	100x400	70022440		109	20309	122,55/pc.	
	100x500	70022450		109	20309	139,25/pc.	
	100x600	70022460		109	20309	185,24/pc.	
	Couvercle pour pièce en T Click						
	Acier galvanisé Sendzimir	100	73022100		109	20309	29,01/pc.
		150	73022150		109	20309	32,44/pc.
		200	73022200		109	20309	37,07/pc.
		300	73022300		109	20309	53,18/pc.
		400	73022400		109	20309	78,86/pc.
		500	73022500		109	20309	113,31/pc.
	600	73022600		109	20309	129,41/pc.	
	Pièce murale verticale						
	Acier galvanisé Sendzimir	60x100	70027100		106	20309	15,20/pc.
		60x150	70027150		106	20309	17,25/pc.
	Livrée sous forme aplanie.						

	type	référence	stock	page. catal.	groupe d'articles	prix en €		
Dérivation Click								
	Acier galvanisé Sendzimir	35x100		70023110	110	20309	26,05/pc.	
		35x150		70023115	110	20309	29,01/pc.	
	Livrée sous forme aplanie.	35x200		70023120	110	20309	33,82/pc.	
		35x300		70023130	110	20309	38,55/pc.	
		60x060		70023206	110	20309	21,49/pc.	
		60x100		70023210	✓	110	20309	21,49/pc.
		60x150		70023215	✓	110	20309	22,45/pc.
		60x200		70023220	✓	110	20309	24,33/pc.
		60x300		70023230	✓	110	20309	37,75/pc.
		60x400		70023240	✓	110	20309	54,33/pc.
		60x500		70023250		110	20309	62,20/pc.
		60x600		70023260		110	20309	65,72/pc.
		85x200		70023320		110	20309	40,94/pc.
		85x300		70023330		110	20309	47,12/pc.
		85x400		70023340		110	20309	55,43/pc.
		85x500		70023350		110	20309	60,18/pc.
		85x600		70023360		110	20309	61,44/pc.
		100x100		70023410		110	20309	32,05/pc.
		100x200		70023420		110	20309	46,88/pc.
		100x300		70023430		110	20309	50,88/pc.
	100x400		70023440		110	20309	61,75/pc.	
	100x500		70023450		110	20309	68,32/pc.	
	100x600		70023460		110	20309	71,04/pc.	
Couvercle pour dérivation Click								
	Acier galvanisé Sendzimir	60		73023060	110	20309	22,13/pc.	
		100		73023100	110	20309	22,13/pc.	
		150		73023150	110	20309	22,45/pc.	
		200		73023200	110	20309	23,56/pc.	
		300		73023300	110	20309	30,42/pc.	
		400		73023400	110	20309	31,74/pc.	
		500		73023500	110	20309	38,63/pc.	
		600		73023600	110	20309	39,99/pc.	
	Croisillon Click							
	Acier galvanisé Sendzimir	35x100		70024110	112	20309	38,00/pc.	
		35x150		70024115	112	20309	41,00/pc.	
	Livrée sous forme aplanie.	35x200		70024120	112	20309	47,49/pc.	
		35x300		70024130	112	20309	56,31/pc.	
		60x100		70024210	112	20309	38,99/pc.	
		60x150		70024215	112	20309	39,50/pc.	
		60x200		70024220	✓	112	20309	45,73/pc.
		60x300		70024230	✓	112	20309	55,80/pc.
		60x400		70024240		112	20309	63,50/pc.
		60x500		70024250		112	20309	118,62/pc.
		60x600		70024260		112	20309	163,48/pc.
		85x200		70024320		112	20309	53,00/pc.
		85x300		70024330		112	20309	64,56/pc.
		85x400		70024340		112	20309	73,63/pc.
		85x500		70024350		112	20309	133,61/pc.
		85x600		70024360		112	20309	184,11/pc.
		100x100		70024410		112	20309	67,78/pc.
		100x200		70024420		112	20309	80,36/pc.
		100x300		70024430		112	20309	110,43/pc.
		100x400		70024440		112	20309	132,05/pc.
	100x500		70024450		112	20309	144,05/pc.	
	100x600		70024460		112	20309	187,68/pc.	

	type	référence	 stock	page. catal.	groupe d'articles	prix en €	
	Couvercle pour croisillon Click						
	Acier galvanisé Sendzimir	100	73024100		112	20309	32,81/pc.
		150	73024150		112	20309	35,82/pc.
		200	73024200		112	20309	40,49/pc.
		300	73024300		112	20309	56,50/pc.
		400	73024400		112	20309	87,12/pc.
		500	73024500		112	20309	123,73/pc.
	600	73024600		112	20309	141,44/pc.	
	Pièce de montée Click						
	Acier galvanisé Sendzimir	35x100	70025110		113	20309	32,24/pc.
		35x150	70025115		113	20309	35,99/pc.
	Livrée sous forme aplanie.	35x200	70025120		113	20309	41,25/pc.
		35x300	70025130		113	20309	47,81/pc.
		60x060	70025206		113	20309	24,33/pc.
		60x100	70025210	✓	113	20309	24,33/pc.
		60x150	70025215	✓	113	20309	29,11/pc.
		60x200	70025220	✓	113	20309	32,03/pc.
		60x300	70025230	✓	113	20309	48,21/pc.
		60x400	70025240		113	20309	63,83/pc.
		60x500	70025250		113	20309	70,29/pc.
		60x600	70025260		113	20309	92,16/pc.
		85x200	70025320		113	20309	49,19/pc.
		85x300	70025330		113	20309	58,12/pc.
		85x400	70025340		113	20309	69,99/pc.
		85x500	70025350		113	20309	102,30/pc.
		85x600	70025360		113	20309	107,12/pc.
		100x100	70025410		113	20309	40,45/pc.
	100x200	70025420		113	20309	51,18/pc.	
	100x300	70025430		113	20309	62,74/pc.	
	100x400	70025440		113	20309	45,23/pc.	
	100x500	70025450		113	20309	107,44/pc.	
	100x600	70025460		113	20309	112,44/pc.	
	Couvercle pour pièce de montée Click						
	Acier galvanisé Sendzimir	60	73025060		113	20309	26,87/pc.
		100	73025100		113	20309	26,87/pc.
		150	73025150		113	20309	30,06/pc.
		200	73025200		113	20309	34,37/pc.
		300	73025300		113	20309	48,07/pc.
		400	73025400		113	20309	73,94/pc.
		500	73025500		113	20309	106,18/pc.
	600	73025600		113	20309	121,31/pc.	

	type	référence	stock	page. catal.	groupe d'articles	prix en €	
Pièce de descente Click							
	Acier galvanisé Sendzimir	35x100		114	20309	32,24/pc.	
		35x150		114	20309	35,99/pc.	
	Livrée sous forme aplanie.	35x200	70026120		114	20309	41,25/pc.
		35x300	70026130		114	20309	47,81/pc.
		60x060	70026206		114	20309	24,33/pc.
		60x100	70026210	✓	114	20309	24,33/pc.
		60x150	70026215	✓	114	20309	29,11/pc.
		60x200	70026220	✓	114	20309	32,03/pc.
		60x300	70026230	✓	114	20309	48,21/pc.
		60x400	70026240	✓	114	20309	63,83/pc.
		60x500	70026250		114	20309	70,29/pc.
		60x600	70026260		114	20309	92,16/pc.
		85x200	70026320		114	20309	43,19/pc.
		85x300	70026330		114	20309	59,37/pc.
		85x400	70026340		114	20309	66,62/pc.
		85x500	70026350		114	20309	79,74/pc.
		85x600	70026360		114	20309	84,42/pc.
		100x100	70026410		114	20309	38,44/pc.
		100x200	70026420		114	20309	46,68/pc.
		100x300	70026430		114	20309	61,75/pc.
	100x400	70026440		114	20309	69,25/pc.	
	100x500	70026450		114	20309	82,12/pc.	
	100x600	70026460		114	20309	89,48/pc.	
Couvercle pour pièce de descente Click							
	Acier galvanisé Sendzimir	60	73026060		114	20309	25,99/pc.
		100	73026100		114	20309	25,99/pc.
		150	73026150		114	20309	29,12/pc.
		200	73026200		114	20309	33,24/pc.
		300	73026300		114	20309	46,56/pc.
		400	73026400		114	20309	71,61/pc.
		500	73026500		114	20309	102,80/pc.
		600	73026600		114	20309	117,49/pc.
Dérivation universelle Click							
	Acier galvanisé Sendzimir	35	70021100		118	20309	14,19/pc.
		60	70021200	✓	118	20309	14,82/pc.
	Livrée sous forme aplanie.	85	70021300		118	20309	17,88/pc.
		100	70021400		118	20309	17,99/pc.



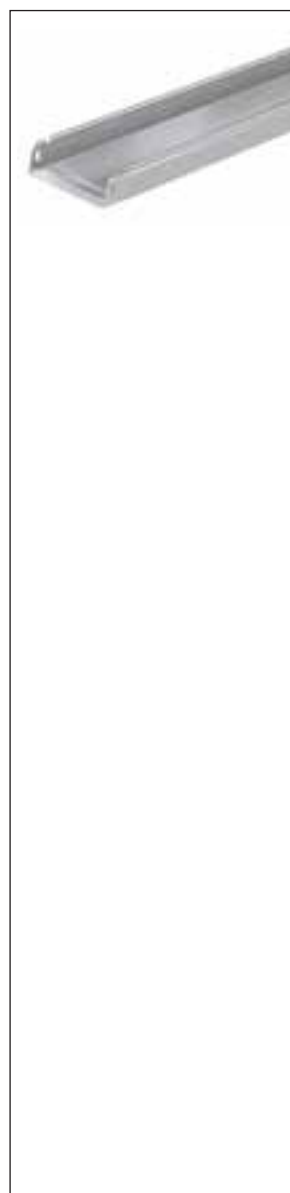

	type	référence	 stock	page. catal.	groupe d'articles	prix en €
Chemin de câbles Pemsaband LX Click, H = 35 mm						
Acier galvanisé à chaud						
↔ 3 m	 24 m	35x100 75831100		092	20308	21,82/m
	 12 m	35x150 75831150		092	20308	27,18/m
		35x200 75831200		092	20308	33,87/m
		35x300 75831300		092	20308	45,36/m
Chemin de câbles Pemsaband LX Click, H = 60 mm						
Acier galvanisé à chaud						
↔ 3 m	 24 m	60x100 75832100		092	20310	21,20/m
	 12 m	60x150 75832150		092	20310	28,81/m
		60x200 75832200		092	20310	33,19/m
	 6 m	60x300 75832300		092	20310	44,38/m
		60x400 75832400		092	20310	56,56/m
		60x500 75832500		092	20310	69,30/m
		60x600 75832600		092	20310	79,69/m
Chemin de câbles Pemsaband SX Click, H = 60 mm						
Acier galvanisé à chaud						
↔ 3 m	 24 m	60x100 75232100	✓	093	20308	27,26/m
	 12 m	60x150 75232150		093	20308	32,18/m
		60x200 75232200	✓	093	20308	38,69/m
	 6 m	60x300 75232300	✓	093	20308	49,25/m
		60x400 75232400	✓	093	20308	63,61/m
		60x500 75232500		093	20308	84,06/m
		60x600 75232600		093	20308	99,80/m
Chemin de câbles Pemsaband LX Click, H = 85 mm						
Acier galvanisé à chaud						
↔ 3 m	 6 m	85x200 75233200		092	20308	45,25/m
		85x300 75233300		092	20308	62,26/m
		85x400 75233400		092	20308	78,12/m
		85x500 75233500		092	20308	91,37/m
		85x600 75233600		092	20308	106,05/m
Chemin de câbles Pemsaband LX, H = 100 mm						
Acier galvanisé à chaud						
↔ 3 m	 6 m	100x100 75234100		092	20308	33,32/m
		100x200 75234200		092	20308	48,63/m
		100x300 75234300		092	20308	59,87/m
		100x400 75234400		092	20308	82,81/m
		100x500 75234500		092	20308	95,43/m
		100x600 75234600		092	20308	111,18/m
Accouplement Rejiband-Pemsaband						
Acier galvanisé à chaud						
	 1 set	60 70130200		106	20309	26,45/set





Gaine à câbles Inducanal Click, H= 35 mm

Acier galvanisé à chaud

type	référence	stock	page. catal.	groupe d'articles	prix en €
↔ 3 m  24 m	35x100 75131100		095	20311	24,31/m
 12 m	35x150 75131150		095	20311	27,88/m
	35x200 75131200		095	20311	33,82/m
	35x300 75131300		095	20311	44,43/m

Gaine à câbles Inducanal Click, H= 60 mm

Acier galvanisé à chaud

↔ 3 m  24 m	60x060 75132060	✓	095	20311	27,37/m
	60x100 75132100		095	20311	27,37/m
 12 m	60x150 75132150		095	20311	35,57/m
	60x200 75132200		095	20311	37,76/m
 6 m	60x300 75132300		095	20311	48,32/m
	60x400 75132400		095	20311	90,74/m
	60x500 75132500		095	20311	102,30/m
	60x600 75132600		095	20311	117,42/m

Gaine à câbles Inducanal Click, H= 85 mm

Acier galvanisé à chaud

↔ 3 m  6 m	85x200 75433200		095	20311	45,62/m
	85x300 75433300		095	20311	57,19/m
	85x400 75433400		095	20311	97,06/m
	85x500 75433500		095	20311	118,93/m
	85x600 75433600		095	20311	129,36/m

Gaine à câbles Inducanal, H = 100 mm

Acier galvanisé à chaud

↔ 3 m  6 m	100x100 75434100		095	20311	42,58/m
	100x200 75434200		095	20311	49,57/m
	100x300 75434300		095	20311	60,56/m
	100x400 75434400		095	20311	100,12/m
	100x500 75434500		095	20311	123,12/m
	100x600 75434600		095	20311	152,86/m

Boulon à collet carré et écrou 6 pans à embase crénelée

Acier galvanisé à chaud

M6x12 67030093	✓	100	20309	0,50/pc.
----------------	---	-----	-------	----------

 100 pc.

Boulon à collet carré

Acier galvanisé à chaud

M6x12 67030099		174	20309	0,34/pc.
----------------	--	-----	-------	----------

 100 pc.











M6x20 67030100	✓	174	20309	0,47/pc.
----------------	---	-----	-------	----------

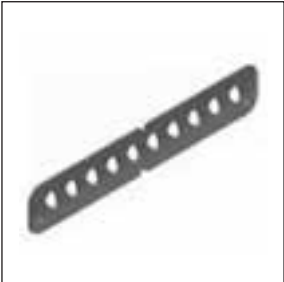
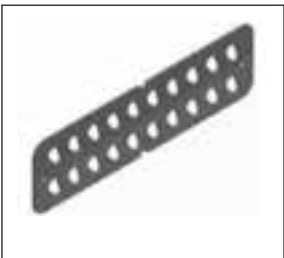
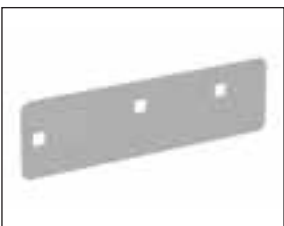





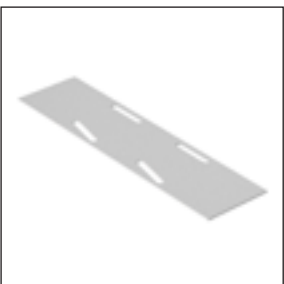







Écrou 6 pans à embase crénelée

Lamellar zinc



M6 64030059	✓	174	20309	0,26/pc.
-------------	---	-----	-------	----------





 50 pc.

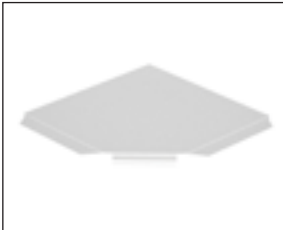

	type	référence	 stock	page. catal.	groupe d'articles	prix en €
	Accouplement					
	Lamellar zinc	35	71031005	✓	100	20309 1,99/pc.
	Accouplement					
	Lamellar zinc	60	93930002	✓	066	20309 3,19/pc.
	Accouplement					
	Lamellar zinc	85/100	93930003		066	20309 5,50/pc.
	Plaque pour pièce de montée/descente					
	Lamellar zinc	35	71031006		100	20309 1,76/pc.
	 4 pc.	4 plaques pour 1 pièce de montée/descente.				
	Plaque pour pièce de montée/descente					
	Lamellar zinc	60	93930012	✓	066	20309 2,76/pc.
	 8 pc.	4 plaques pour 1 pièce de montée/descente.				
	Plaque pour pièce de montée/descente					
	Lamellar zinc	85/100	93930013		066	20309 5,19/pc.
	 8 pc.	4 plaques pour 1 pièce de montée/descente.				
	Accouplement de fond					
	Acier galvanisé à chaud	300	71030300		100	20309 11,88/pc.
	 10 pc.	400	71030400		100	20309 13,75/pc.
		500	71030500		100	20309 18,75/pc.
		600	71030600		100	20309 22,50/pc.





	type	référence	 stock	page. catal.	groupe d'articles	prix en €	
	Plaque de montage Pemsaband						
	Lamellar zinc  10 pc.	60 70430911		104	20309	9,57/pc.	
	Bande de protection						
	Caoutchouc/adhésif  25 m	71000000	✓	104	20309	7,19/m	
	Borne de terre						
	Laiton  20 pc.	16-50 mm ² 68000034 50-110 mm ² 68000035	✓	106 106	20309 20309	6,11/pc. 12,27/pc.	
	Couvercle Click						
	Acier galvanisé à chaud						
	↔ 3 m  24 m	60 100	73031060 73031100	✓ ✓	102 102	20316 20316	12,19/m 17,01/m
	 12 m	150 200	73031150 73031200	✓ ✓	102 102	20316 20316	23,12/m 29,25/m
	 6 m	300 400 500 600	73031300 73031400 73031500 73031600	✓	102 102 102 102	20316 20316 20316 20316	44,49/m 57,61/m 70,73/m 83,86/m
	Cloison de séparation						
	Acier galvanisé à chaud						
↔ 3 m  60 m	25	67030610	✓	104	20316	9,94/m	
 48 m	50	67030611	✓	104	20316	13,49/m	
 36 m	80	67030612		104	20316	19,00/m	
	Plaque d'identification						
	Matière synthétique  50 pc.	68000020		034	20307	1,21/pc.	

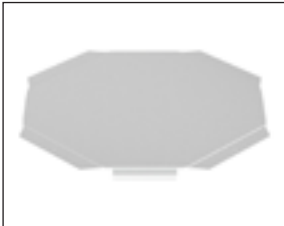

	type	référence	 stock	page. catal.	groupe d'articles	prix en €	
	Courbe réglable						
	Acier galvanisé à chaud	35x100	70038110	116	20309	41,88/pc.	
		35x150	70038115	116	20309	44,80/pc.	
		35x200	70038120	116	20309	53,31/pc.	
		35x300	70038130	116	20309	62,18/pc.	
		60x100	70038210	116	20309	43,11/pc.	
		60x150	70038215	116	20309	46,68/pc.	
		60x200	70038220	116	20309	55,31/pc.	
		60x300	70038230	116	20309	65,18/pc.	
		Embout					
Acier galvanisé à chaud		35x100	70039110	118	20309	24,56/pc.	
		35x150	70039115	118	20309	32,07/pc.	
		35x200	70039120	118	20309	37,43/pc.	
		35x300	70039130	118	20309	49,87/pc.	
		60x100	70039210	118	20309	26,50/pc.	
		60x150	70039215	118	20309	33,87/pc.	
		60x200	70039220	118	20309	41,00/pc.	
		60x300	70039230	118	20309	56,62/pc.	
		60x400	70039240	118	20309	83,24/pc.	
		60x500	70039250	118	20309	101,99/pc.	
		60x600	70039260	118	20309	122,18/pc.	
		85x200	70039320	118	20309	58,06/pc.	
		85x300	70039330	118	20309	86,93/pc.	
		85x400	70039340	118	20309	99,43/pc.	
		85x500	70039350	118	20309	119,98/pc.	
		85x600	70039360	118	20309	140,68/pc.	
		100x100	70039410	118	20309	33,04/pc.	
		100x200	70039420	118	20309	64,12/pc.	
		100x300	70039430	118	20309	90,31/pc.	
		100x400	70039440	118	20309	105,74/pc.	
		100x500	70039450	118	20309	123,62/pc.	
		100x600	70039460	118	20309	145,36/pc.	
		Réduction					
		Acier galvanisé à chaud	35x100	71031010	116	20309	25,00/pc.
		35x150	71031015	116	20309	32,55/pc.	
		35x200	71031020	116	20309	38,00/pc.	
		35x300	71031030	116	20309	50,62/pc.	
		60x100	71032010	116	20309	26,87/pc.	
		60x150	71032015	116	20309	34,37/pc.	
		60x200	71032020	116	20309	41,61/pc.	
		60x300	71032030	116	20309	54,24/pc.	
		60x400	71032040	116	20309	83,24/pc.	
		60x500	71032050	116	20309	101,99/pc.	
		60x600	71032060	116	20309	122,18/pc.	
		85x200	71033020	116	20309	58,06/pc.	
		85x300	71033030	116	20309	86,93/pc.	
		85x400	71033040	116	20309	99,43/pc.	
		85x500	71033050	116	20309	119,98/pc.	
		85x600	71033060	116	20309	140,68/pc.	
		100x100	71034010	116	20309	33,04/pc.	
		100x200	71034020	116	20309	59,92/pc.	
		100x300	71034030	116	20309	84,36/pc.	
		100x400	71034040	116	20309	98,80/pc.	
		100x500	71034050	116	20309	115,56/pc.	
		100x600	71034060	116	20309	135,88/pc.	

	type	référence	 stock	page. catal.	groupe d'articles	prix en €	
	Pièce murale verticale						
	Acier galvanisé à chaud	60x100	70037100		106	20309	38,43/pc.
		60x150	70037150		106	20309	43,31/pc.
	Courbe Click 90°						
	Acier galvanisé à chaud	35x100	70030110		108	20309	30,13/pc.
		35x150	70030115		108	20309	33,56/pc.
		35x200	70030120		108	20309	38,55/pc.
		35x300	70030130		108	20309	51,06/pc.
		60x100	70030210	✓	108	20309	32,38/pc.
		60x150	70030215		108	20309	35,11/pc.
		60x200	70030220	✓	108	20309	40,19/pc.
		60x300	70030230	✓	108	20309	54,63/pc.
		60x400	70030240		108	20309	93,63/pc.
		60x500	70030250		108	20309	143,18/pc.
		60x600	70030260		108	20309	172,80/pc.
		85x200	70030320		108	20309	44,24/pc.
		85x300	70030330		108	20309	58,42/pc.
		85x400	70030340		108	20309	111,98/pc.
		85x500	70030350		108	20309	157,60/pc.
		85x600	70030360		108	20309	181,30/pc.
		100x100	70030410		108	20309	68,47/pc.
		100x200	70030420		108	20309	78,86/pc.
		100x300	70030430		108	20309	94,81/pc.
	100x400	70030440		108	20309	171,36/pc.	
	100x500	70030450		108	20309	206,19/pc.	
	100x600	70030460		108	20309	267,17/pc.	
	Couvercle pour courbe Click 90°						
	Acier galvanisé à chaud	100	73030100		108	20309	26,29/pc.
		150	73030150		108	20309	29,50/pc.
		200	73030200		108	20309	32,93/pc.
		300	73030300		108	20309	47,06/pc.
		400	73030400		108	20309	79,00/pc.
		500	73030500		108	20309	101,67/pc.
	600	73030600		108	20309	118,80/pc.	









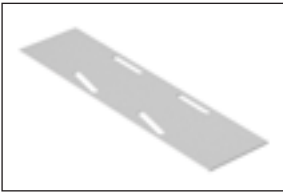

	type	référence	 stock	page. catal.	groupe d'articles	prix en €
Pièce en T Click						
	Acier galvanisé à chaud					
	35x100	70032110		109	20309	41,93/pc.
	35x150	70032115		109	20309	46,80/pc.
	35x200	70032120		109	20309	54,88/pc.
	35x300	70032130		109	20309	61,50/pc.
	60x100	70032210	✓	109	20309	44,69/pc.
	60x150	70032215		109	20309	48,94/pc.
	60x200	70032220	✓	109	20309	55,93/pc.
	60x300	70032230	✓	109	20309	72,17/pc.
	60x400	70032240		109	20309	123,05/pc.
	60x500	70032250		109	20309	170,80/pc.
	60x600	70032260		109	20309	205,36/pc.
	85x200	70032320		109	20309	63,68/pc.
	85x300	70032330		109	20309	87,23/pc.
	85x400	70032340		109	20309	170,92/pc.
	85x500	70032350		109	20309	214,06/pc.
	85x600	70032360		109	20309	261,35/pc.
	100x100	70032410		109	20309	72,39/pc.
	100x200	70032420		109	20309	97,11/pc.
	100x300	70032430		109	20309	140,19/pc.
100x400	70032440		109	20309	173,94/pc.	
100x500	70032450		109	20309	227,91/pc.	
100x600	70032460		109	20309	278,30/pc.	
Couvercle pour pièce en T Click						
	Acier galvanisé à chaud					
	100	73032100		109	20309	52,62/pc.
	150	73032150		109	20309	57,29/pc.
	200	73032200		109	20309	64,49/pc.
	300	73032300		109	20309	87,68/pc.
	400	73032400		109	20309	137,86/pc.
	500	73032500		109	20309	198,23/pc.
600	73032600		109	20309	202,85/pc.	
Dérivation Click						
	Acier galvanisé à chaud					
	35x100	70033110		110	20309	32,24/pc.
	35x150	70033115		110	20309	35,99/pc.
	35x200	70033120		110	20309	42,24/pc.
	35x300	70033130		110	20309	48,94/pc.
	60x100	70033210	✓	110	20309	34,37/pc.
	60x150	70033215		110	20309	38,50/pc.
	60x200	70033220	✓	110	20309	44,00/pc.
	60x300	70033230	✓	110	20309	50,81/pc.
	60x400	70033240	✓	110	20309	59,81/pc.
	60x500	70033250		110	20309	65,37/pc.
	60x600	70033260		110	20309	71,38/pc.
	85x200	70033320		110	20309	51,81/pc.
	85x300	70033330		110	20309	58,42/pc.
	85x400	70033340		110	20309	62,48/pc.
	85x500	70033350		110	20309	69,94/pc.
	85x600	70033360		110	20309	72,86/pc.
	100x100	70033410		110	20309	41,43/pc.
	100x200	70033420		110	20309	56,31/pc.
	100x300	70033430		110	20309	63,00/pc.
100x400	70033440		110	20309	69,43/pc.	
100x500	70033450		110	20309	76,35/pc.	
100x600	70033460		110	20309	79,07/pc.	





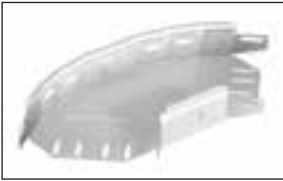

	type	référence	 stock	page. catal.	groupe d'articles	prix en €
	Couvercle pour dérivation Click					
	Acier galvanisé à chaud	100	73033100	110	20309	25,82/pc.
		150	73033150	110	20309	27,31/pc.
		200	73033200	110	20309	28,76/pc.
		300	73033300	110	20309	36,75/pc.
		400	73033400	110	20309	38,63/pc.
		500	73033500	110	20309	46,75/pc.
	Croisillon Click					
	Acier galvanisé à chaud	35x100	70034110	112	20309	46,88/pc.
		35x150	70034115	112	20309	51,76/pc.
		35x200	70034120	112	20309	59,92/pc.
		35x300	70034130	112	20309	69,49/pc.
		60x100	70034210	112	20309	48,80/pc.
		60x150	70034215	112	20309	54,06/pc.
		60x200	70034220	112	20309	62,43/pc.
		60x300	70034230	112	20309	84,26/pc.
		60x400	70034240	112	20309	134,38/pc.
		60x500	70034250	112	20309	193,04/pc.
		60x600	70034260	112	20309	221,29/pc.
		85x200	70034320	112	20309	70,36/pc.
		85x300	70034330	112	20309	94,00/pc.
		85x400	70034340	112	20309	142,06/pc.
		85x500	70034350	112	20309	234,23/pc.
		85x600	70034360	112	20309	286,33/pc.
		100x100	70034410	112	20309	91,43/pc.
		100x200	70034420	112	20309	101,80/pc.
		100x300	70034430	112	20309	150,98/pc.
		100x400	70034440	112	20309	199,67/pc.
	100x500	70034450	112	20309	239,43/pc.	
	100x600	70034460	112	20309	292,73/pc.	
	Couvercle pour croisillon Click					
	Acier galvanisé à chaud	100	73034100	112	20309	39,75/pc.
		150	73034150	112	20309	44,49/pc.
		200	73034200	112	20309	49,67/pc.
		300	73034300	112	20309	81,36/pc.
		400	73034400	112	20309	109,37/pc.
		500	73034500	112	20309	157,12/pc.
	600	73034600	112	20309	179,47/pc.	



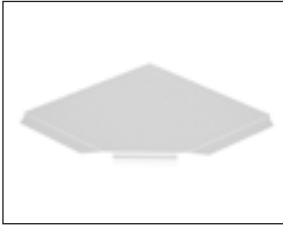



	type	référence	 stock	page. catal.	groupe d'articles	prix en €	
	Pièce de montée Click						
	Acier galvanisé à chaud						
		35x100	70035110		113	20309	39,81/pc.
		35x150	70035115		113	20309	44,43/pc.
		35x200	70035120		113	20309	50,93/pc.
		35x300	70035130		113	20309	59,05/pc.
		60x100	70035210		113	20309	41,88/pc.
		60x150	70035215		113	20309	46,94/pc.
		60x200	70035220		113	20309	53,61/pc.
		60x300	70035230		113	20309	74,05/pc.
		60x400	70035240		113	20309	97,32/pc.
		60x500	70035250		113	20309	113,74/pc.
		60x600	70035260		113	20309	124,05/pc.
		85x200	70035320		113	20309	62,06/pc.
		85x300	70035330		113	20309	76,62/pc.
		85x400	70035340		113	20309	92,06/pc.
		85x500	70035350		113	20309	122,61/pc.
		85x600	70035360		113	20309	127,68/pc.
		100x100	70035410		113	20309	55,58/pc.
		100x200	70035420		113	20309	68,17/pc.
	100x300	70035430		113	20309	80,50/pc.	
	100x400	70035440		113	20309	99,43/pc.	
	100x500	70035450		113	20309	134,87/pc.	
	100x600	70035460		113	20309	140,43/pc.	
	Couvercle pour pièce de montée Click						
	Acier galvanisé à chaud						
		100	73035100		113	20309	33,13/pc.
		150	73035150		113	20309	37,12/pc.
		200	73035200		113	20309	42,43/pc.
		300	73035300		113	20309	69,56/pc.
		400	73035400		113	20309	91,24/pc.
	500	73035500		113	20309	131,05/pc.	
	600	73035600		113	20309	131,05/pc.	
	Pièce de descente Click						
	Acier galvanisé à chaud						
		35x100	70036110		114	20309	40,43/pc.
		35x150	70036115		114	20309	45,20/pc.
		35x200	70036120		114	20309	51,76/pc.
		35x300	70036130		114	20309	60,01/pc.
		60x100	70036210		114	20309	42,13/pc.
		60x150	70036215		114	20309	47,18/pc.
		60x200	70036220		114	20309	53,93/pc.
		60x300	70036230		114	20309	66,26/pc.
		60x400	70036240		114	20309	86,29/pc.
		60x500	70036250		114	20309	97,34/pc.
		60x600	70036260		114	20309	101,11/pc.
		85x200	70036320		114	20309	56,31/pc.
		85x300	70036330		114	20309	70,87/pc.
		85x400	70036340		114	20309	85,68/pc.
		85x500	70036350		114	20309	98,69/pc.
		85x600	70036360		114	20309	102,44/pc.
		100x100	70036410		114	20309	51,73/pc.
		100x200	70036420		114	20309	61,93/pc.
	100x300	70036430		114	20309	74,43/pc.	
	100x400	70036440		114	20309	90,81/pc.	
	100x500	70036450		114	20309	103,62/pc.	
	100x600	70036460		114	20309	112,69/pc.	

	type	référence	 stock	page. catal.	groupe d'articles	prix en €	
	Couvercle pour pièce de descente Click						
	Acier galvanisé à chaud	100	73036100		114	20309	31,82/pc.
		150	73036150		114	20309	35,62/pc.
		200	73036200		114	20309	40,69/pc.
		300	73036300		114	20309	56,93/pc.
		400	73036400		114	20309	87,55/pc.
		500	73036500		114	20309	125,81/pc.
	600	73036600		114	20309	143,74/pc.	
	Dérivation universelle Click						
	Acier galvanisé à chaud	35	70031100		118	20309	20,26/pc.
		60	70031200	✓	118	20309	21,67/pc.
		85	70031300		118	20309	25,68/pc.
		100	70031400		118	20309	26,24/pc.

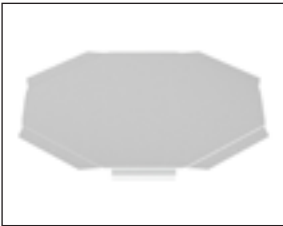
	type	référence	 stock	page. catal.	groupe d'articles	prix en €	
	Chemin de câbles Pemsaband, H = 60 mm						
	Acier inoxydable AISI 304						
	↔ 3 m  24 m	60x100	76452100	✓	096	20315	64,60/m
	 12 m	60x150 60x200	76452150 76452200	✓	096 096	20315 20315	65,29/m 90,12/m
	 6 m	60x300 60x400 60x500 60x600	76452300 76452400 76452500 76452600	✓	096 096 096 096	20315 20315 20315 20315	113,57/m 115,89/m 158,76/m 201,03/m
		Gaine à câbles Inducanal, H = 60 mm					
		Acier inoxydable AISI 304					
↔ 3 m  24 m		60x100	76552100	✓	097	20315	62,79/m
 12 m		60x150 60x200	76552150 76552200	✓	097 097	20315 20315	65,53/m 90,27/m
 6 m		60x300 60x400 60x500 60x600	76552300 76552400 76552500 76552600	✓	097 097 097 097	20315 20315 20315 20315	113,81/m 116,09/m 159,58/m 201,78/m
		Boulon à collet carré					
		Acier inoxydable AISI 316L	M6x12	67060099	✓	174	20309
	Ecrou 6 pans à embase crénelée						
	Acier inoxydable AISI 316L	M6	64060059	✓	174	20309	1,03/pc.
	 100 pc.						
	Accouplement						
	Acier inoxydable AISI 304	60	93950002	✓	066	20309	7,96/pc.
	 50 pc.						
	Plaque pour pièce de montée/descente						
	Acier inoxydable AISI 304	60	93950012	✓	066	20309	8,28/pc.
	 8 pc.						
	4 plaques pour 1 pièce de montée/descente.						

	type	référence	stock	page. catal.	groupe d'articles	prix en €	
	Accouplement						
	Acier inoxydable AISI 304	300	71050300	100	20309	17,60/pc.	
	 10 pc.	400	71050400	100	20309	24,01/pc.	
		500	71050500	100	20309	29,68/pc.	
		600	71050600	100	20309	34,65/pc.	
Couvercle Click							
	Acier inoxydable AISI 304						
	↔ 3 m  24 m	100	73051100	✓	102	20316	43,28/m
	 12 m	150	73051150	✓	102	20316	57,74/m
		200	73051200	✓	102	20316	70,70/m
	 6 m	300	73051300	✓	102	20316	98,82/m
		400	73051400		102	20316	127,57/m
		500	73051500		102	20316	138,82/m
		600	73051600		102	20316	190,38/m
		Cloison de séparation					
		Acier inoxydable 304	50	67050611		104	20316
↔ 3 m  48 m							
	Courbe réglable						
	Acier inoxydable AISI 304	60x100	70058210	116	20309	39,22/pc.	
		60x150	70058215	116	20309	62,18/pc.	
		60x200	70058220	116	20309	68,59/pc.	
		60x300	70058230	116	20309	115,23/pc.	
	Embout et réduction						
	Acier inoxydable AISI 304	60x100	71052010	116	20309	46,25/pc.	
		60x150	71052015	116	20309	60,24/pc.	
		60x200	71052020	116	20309	79,82/pc.	
		60x300	71052030	116	20309	102,87/pc.	
		60x400	71052040	116	20309	93,58/pc.	
		60x500	71052050	116	20309	119,91/pc.	
		60x600	71052060	116	20309	147,59/pc.	
	Courbe Click 90°						
	Acier inoxydable AISI 304	60x100	70050210	✓	108	20309	50,71/pc.
		60x150	70050215		108	20309	57,19/pc.
		60x200	70050220	✓	108	20309	88,84/pc.
		60x300	70050230		108	20309	116,09/pc.
		60x400	70050240		108	20309	163,36/pc.
		60x500	70050250		108	20309	237,72/pc.
		60x600	70050260		108	20309	240,61/pc.

	type	référence	 stock	page. catal.	groupe d'articles	prix en €	
	Couvercle pour courbe Click 90°						
	Acier inoxydable AISI 304	100	73050100		108	20309	54,68/pc.
		150	73050150		108	20309	65,09/pc.
		200	73050200		108	20309	90,77/pc.
		300	73050300		108	20309	98,20/pc.
		400	73050400		108	20309	177,72/pc.
		500	73050500		108	20309	223,41/pc.
	Pièce en T Click						
	Acier inoxydable AISI 304	60x100	70052210	✓	109	20309	62,28/pc.
		60x150	70052215		109	20309	68,05/pc.
		60x200	70052220	✓	109	20309	87,65/pc.
		60x300	70052230		109	20309	116,09/pc.
		60x400	70052240		109	20309	235,14/pc.
		60x500	70052250		109	20309	237,32/pc.
	Couvercle pour pièce en T Click						
	Acier inoxydable AISI 304	100	73052100		109	20309	74,13/pc.
		150	73052150		109	20309	92,12/pc.
		200	73052200		109	20309	116,55/pc.
		300	73052300		109	20309	152,27/pc.
		400	73052400		109	20309	294,13/pc.
		500	73052500		109	20309	319,89/pc.
	Dérivation Click						
	Acier inoxydable AISI 304	60x100	70053210		110	20309	45,78/pc.
		60x150	70053215		110	20309	46,02/pc.
		60x200	70053220		110	20309	58,68/pc.
		60x300	70053230		110	20309	59,05/pc.
		60x400	70053240		110	20309	82,03/pc.
		60x500	70053250		110	20309	82,11/pc.
	Couvercle pour dérivation Click						
	Acier inoxydable AISI 304	100	73053100		110	20309	49,84/pc.
		150	73053150		110	20309	51,40/pc.
		200	73053200		110	20309	52,27/pc.
		300	73053300		110	20309	68,20/pc.
		400	73053400		110	20309	65,85/pc.
		500	73053500		110	20309	92,19/pc.
	Croisillon Click						
	Acier inoxydable AISI 304	60x100	70054210		112	20309	68,27/pc.
		60x150	70054215		112	20309	99,45/pc.
		60x200	70054220		112	20309	90,63/pc.
		60x300	70054230		112	20309	162,17/pc.
		60x400	70054240		112	20309	234,84/pc.
		60x500	70054250		112	20309	237,72/pc.
	60x600	70054260		112	20309	318,97/pc.	

	type	référence	 stock	page. catal.	groupe d'articles	prix en €
	Couvercle pour croisillon Click					
	Acier inoxydable AISI 304	100	73054100	112	20309	87,11/pc.
		150	73054150	112	20309	108,82/pc.
		200	73054200	112	20309	106,55/pc.
		300	73054300	112	20309	187,65/pc.
		400	73054400	112	20309	242,56/pc.
		500	73054500	112	20309	303,66/pc.
	600	73054600	112	20309	358,80/pc.	
	Pièce de montée Click					
	Acier inoxydable AISI 304	60x100	70055210	113	20309	60,30/pc.
		60x150	70055215	113	20309	71,01/pc.
		60x200	70055220	113	20309	72,11/pc.
		60x300	70055230	113	20309	88,27/pc.
		60x400	70055240	113	20309	112,66/pc.
		60x500	70055250	113	20309	163,20/pc.
	60x600	70055260	113	20309	163,20/pc.	
	Couvercle pour pièce de montée Click					
	Acier inoxydable AISI 304	100	73055100	113	20309	52,35/pc.
		150	73055150	113	20309	59,21/pc.
		200	73055200	113	20309	68,99/pc.
		300	73055300	113	20309	100,23/pc.
		400	73055400	113	20309	123,12/pc.
		500	73055500	113	20309	148,67/pc.
	600	73055600	113	20309	222,41/pc.	
	Pièce de descente Click					
	Acier inoxydable AISI 304	60x100	70056210	114	20309	44,38/pc.
		60x150	70056215	114	20309	52,19/pc.
		60x200	70056220	114	20309	68,99/pc.
		60x300	70056230	114	20309	84,68/pc.
		60x400	70056240	114	20309	110,61/pc.
		60x500	70056250	114	20309	121,71/pc.
	60x600	70056260	114	20309	132,96/pc.	
	Couvercle pour pièce de descente Click					
	Acier inoxydable AISI 304	100	73056100	114	20309	74,61/pc.
		150	73056150	114	20309	78,43/pc.
		200	73056200	114	20309	96,86/pc.
		300	73056300	114	20309	124,37/pc.
		400	73056400	114	20309	190,15/pc.
		500	73056500	114	20309	260,62/pc.
	600	73056600	114	20309	329,82/pc.	
	Dérivation universelle Click					
	Acier inoxydable AISI 304	60	70051200	118	20309	21,34/pc.

inducanal[®] gaines à câbles fermées

pemsa[®] chemins de câbles perforés



GS



HD • 304 • 3016L

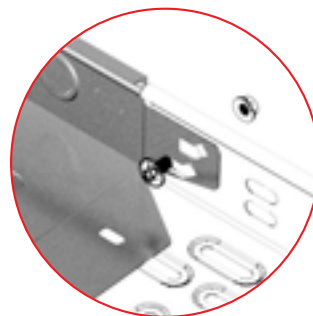

Systeme Click
Sans accouplements

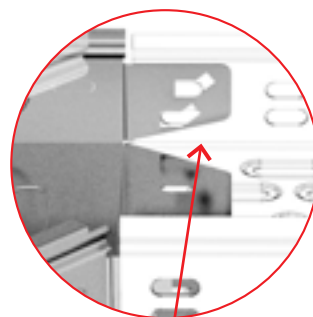
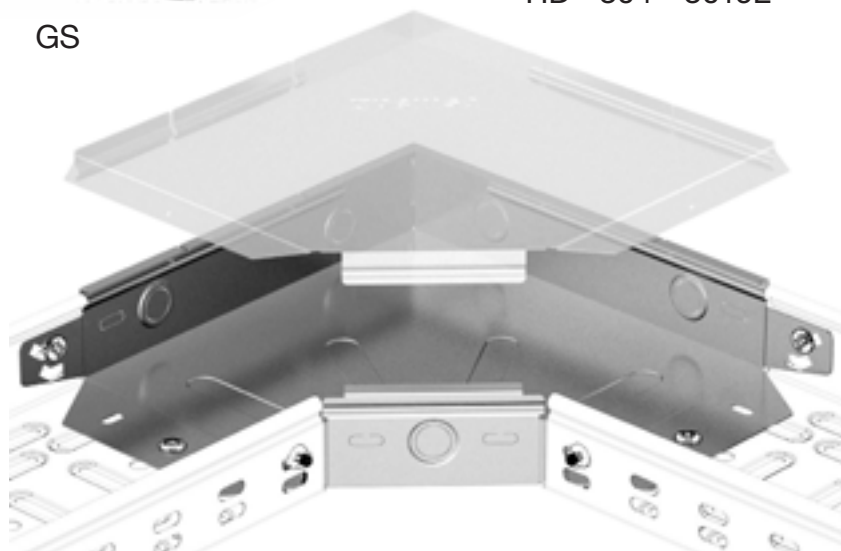

Systeme universel brevet

Compatible avec tous les porteurs de câbles

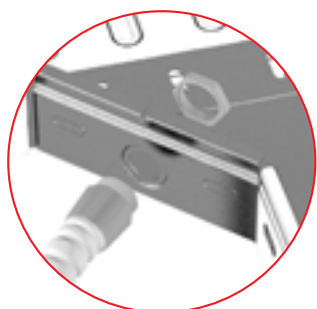





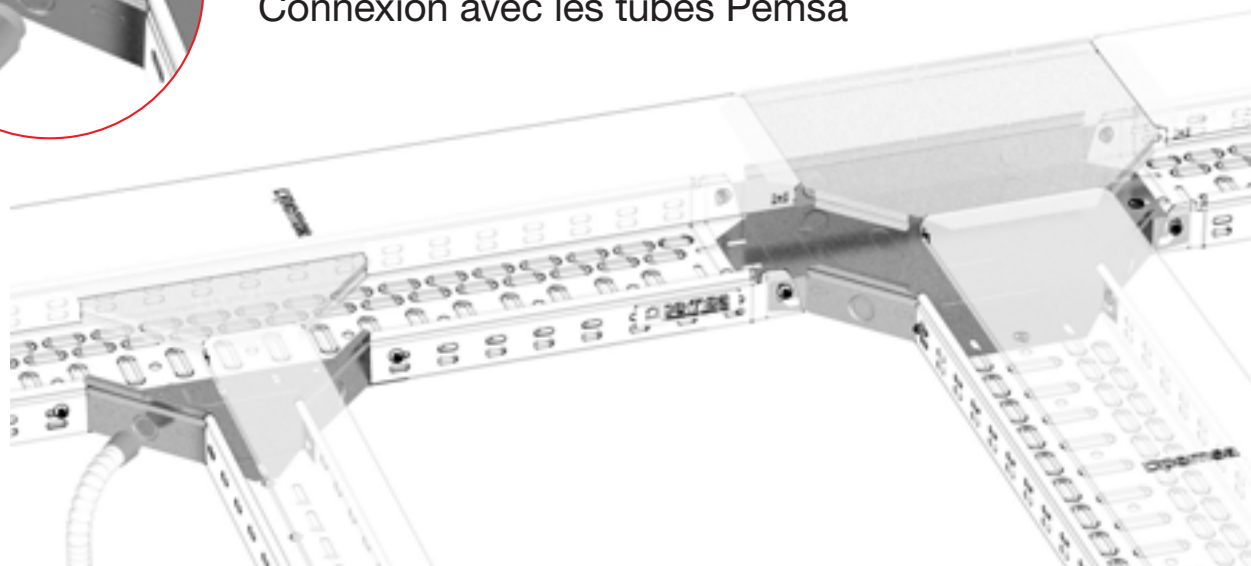







Sortie de tubes

Connexion avec les tubes Pemsa

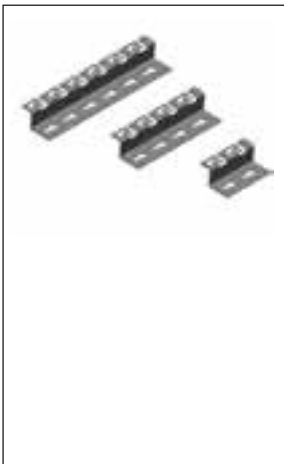

Systemes de suspension – chemins et gaines à câbles

	type	référence	stock	page. catal.	groupe d'articles	prix en €	
	RPLUS console Click						
	Acier galvanisé Sendzimir	100	62025103	✓	128	20307	8,14/pc.
	 4 pc.	150	62025153	✓	128	20307	9,50/pc.
		200	62025203	✓	128	20307	10,93/pc.
		300	62025303	✓	128	20307	12,51/pc.
		400	62025403		128	20307	18,07/pc.
		500	62025503		128	20307	20,97/pc.
600		62025603		128	20307	23,86/pc.	
	RPLUS console Click						
	Acier galvanisé à chaud	100	62035103	✓	128	20307	12,58/pc.
	 4 pc.	150	62035153	✓	128	20307	14,06/pc.
		200	62035203	✓	128	20307	16,61/pc.
		300	62035303	✓	128	20307	20,56/pc.
		400	62035403	✓	128	20307	23,00/pc.
		500	62035503		128	20307	28,68/pc.
600		62035603		128	20307	33,37/pc.	
	RPLUS console						
	Acier inoxydable AISI 304	100	62055103	✓	128	20307	28,30/pc.
	 4 pc.	150	62055153	✓	128	20307	31,20/pc.
		200	62055203	✓	128	20307	34,90/pc.
		300	62055303	✓	128	20307	42,37/pc.
	 4 pc.	400	62055403	✓	128	20307	70,99/pc.
		500	62055503	✓	128	20307	80,11/pc.
600		62055603	✓	128	20307	91,02/pc.	
Kit embout étrier réglable							
Acier galvanisé à chaud		62037002		130	20307	20,23/pc.	
 4 pc.	Kit embout étrier réglable						
	Acier inoxydable AISI 304		62057002		130	20307	sur demande
	RPLUS distanceur Click						
	Acier galvanisé Sendzimir	100	67020520	✓	140	20307	8,11/pc.
	 10 pc.	200	67020522	✓	140	20307	9,70/pc.
		300	67020524	✓	140	20307	11,15/pc.
RPLUS distanceur Click							
Acier galvanisé à chaud	100	67030520	✓	140	20307	10,06/pc.	
 10 pc.	200	67030522	✓	140	20307	12,79/pc.	
	300	67030524	✓	140	20307	15,39/pc.	
	RPLUS distanceur Click						
Acier inoxydable AISI 304	100	67050520	✓	140	20307	12,54/pc.	
 10 pc.	200	67050522	✓	140	20307	20,69/pc.	
	300	67050524	✓	140	20307	28,48/pc.	

Systemes de suspension – chemins et gaines à câbles



SPLUS console Oméga Click

	type	référence	stock	page. catal.	groupe d'articles	prix en €
Acier galvanisé Sendzimir 5 pc.	100	62021104	✓	126	20307	6,52/pc.
	150	62021154	✓	126	20307	8,42/pc.
	200	62021204	✓	126	20307	9,65/pc.
	300	62021304	✓	126	20307	11,38/pc.
	400	62021404	✓	126	20307	17,01/pc.

SPLUS console Oméga Click

	type	référence	stock	page. catal.	groupe d'articles	prix en €
Acier galvanisé à chaud 5 pc.	100	62031104	✓	126	20307	9,98/pc.
	150	62031154		126	20307	12,76/pc.
	200	62031204	✓	126	20307	13,68/pc.
	300	62031304	✓	126	20307	14,63/pc.
	400	62031404		126	20307	22,57/pc.

SPLUS console Oméga Click

	type	référence	stock	page. catal.	groupe d'articles	prix en €
Acier inoxydable AISI 304 5 pc.	100	62051104		126	20307	20,62/pc.
	150	62051154		126	20307	25,58/pc.
	200	62051204		126	20307	32,18/pc.
	300	62051304		126	20307	39,00/pc.
	400	62051404		126	20307	47,44/pc.

SPLUS pendard Oméga

	type	référence	stock	page. catal.	groupe d'articles	prix en €
Acier galvanisé Sendzimir 5 pc.	500	62021504	✓	144	20307	19,45/pc.
	600	62021604	✓	144	20307	23,20/pc.

SPLUS pendard Oméga

	type	référence	stock	page. catal.	groupe d'articles	prix en €
Acier galvanisé à chaud 5 pc.	500	62031504		144	20307	26,18/pc.
	600	62031604		144	20307	31,34/pc.

SPLUS pendard Oméga

	type	référence	stock	page. catal.	groupe d'articles	prix en €
Acier inoxydable AISI 304 5 pc.	500	62051504		144	20307	54,81/pc.
	600	62051604		144	20307	62,38/pc.



SPLUS étrier en C Oméga Click

	type	référence	stock	page. catal.	groupe d'articles	prix en €
Acier galvanisé Sendzimir 4 pc.	100	62022104	✓	126	20307	12,87/pc.
	150	62022154	✓	126	20307	13,52/pc.
	200	62022204	✓	126	20307	14,54/pc.
	300	62022304	✓	126	20307	17,01/pc.
	400	62022404	✓	126	20307	25,10/pc.

SPLUS étrier en C Oméga Click







	type	référence	stock	page. catal.	groupe d'articles	prix en €
Acier galvanisé à chaud 4 pc.	100	62032104	✓	126	20307	17,01/pc.
	150	62032154		126	20307	18,71/pc.
	200	62032204	✓	126	20307	20,89/pc.
	300	62032304	✓	126	20307	25,03/pc.
	400	62032404		126	20307	38,27/pc.

SPLUS étrier en C Oméga Click

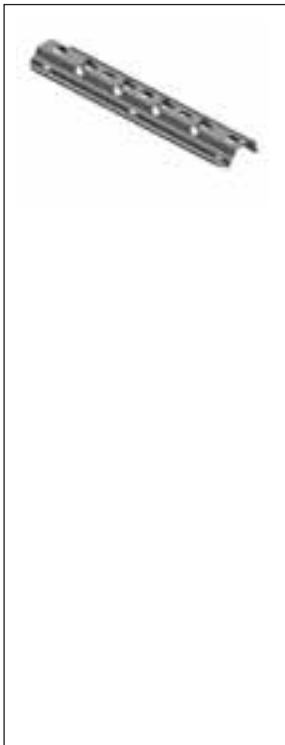
	type	référence	stock	page. catal.	groupe d'articles	prix en €
Acier inoxydable AISI 304 4 pc.	100	62052104		126	20307	35,19/pc.
	150	62052154		126	20307	38,17/pc.
	200	62052204		126	20307	50,18/pc.
	300	62052304		126	20307	57,65/pc.
	400	62052404		126	20307	66,63/pc.



Systemes de suspension – chemins et gaines à câbles

	type	référence	stock	page. catal.	groupe d'articles	prix en €	
	SPLUS console Oméga Click						
	Acier galvanisé Sendzimir	100	63022104	✓	142	20307	4,41/pc.
	 10 pc.	150	63022154	✓	142	20307	4,87/pc.
		200	63022204	✓	142	20307	6,11/pc.
		300	63022304	✓	142	20307	7,19/pc.
		400	63022404	✓	142	20307	9,72/pc.
		500	63022504	✓	142	20307	10,95/pc.
600		63022604	✓	142	20307	14,47/pc.	
SPLUS console Oméga Click							
Acier galvanisé à chaud	100	63032104		142	20307	7,33/pc.	
 10 pc.	150	63032154		142	20307	7,84/pc.	
	200	63032204		142	20307	9,59/pc.	
	300	63032304		142	20307	11,51/pc.	
	400	63032404		142	20307	13,98/pc.	
	500	63032504		142	20307	16,50/pc.	
	600	63032604		142	20307	19,75/pc.	
SPLUS console Oméga Click							
Acier inoxydable AISI 304	100	63052104		142	20307	14,02/pc.	
 10 pc.	150	63052154		142	20307	16,93/pc.	
	200	63052204		142	20307	19,63/pc.	
	300	63052304		142	20307	24,52/pc.	
	400	63052404		142	20307	31,19/pc.	
	500	63052504		142	20307	38,09/pc.	
	600	63052604		142	20307	46,21/pc.	
SPLUS profilé Oméga Click							
Acier galvanisé Sendzimir							
↔ 1 m		67020110		142	20307	29,33/m	
↔ 2 m		67020111		142	20307	29,33/m	
↔ 3 m		67020112		142	20307	29,33/m	
SPLUS profilé Oméga Click							
Acier galvanisé à chaud							
↔ 1 m		67030110		142	20307	47,80/m	
↔ 2 m		67030111		142	20307	47,80/m	
↔ 3 m		67030112		142	20307	47,80/m	
Etrier intérieur avec écrou M10							
Acier galvanisé Sendzimir	100	70122210	✓	136	20309	7,34/pc.	
 10 pc.	150	70122215	✓	136	20309	8,89/pc.	
	200	70122220	✓	136	20309	10,33/pc.	
	300	70122230	✓	136	20309	13,35/pc.	
	400	70122240	✓	136	20309	16,21/pc.	
Etrier intérieur avec écrou M10							
Lamellar zinc	100	70132210		136	20309	10,22/pc.	
 10 pc.	150	70132215		136	20309	12,38/pc.	
	200	70132220		136	20309	14,65/pc.	
	300	70132230		136	20309	18,99/pc.	
	400	70132240		136	20309	23,19/pc.	

Systemes de suspension – chemins et gaines à câbles

	type	référence	 stock	page. catal.	groupe d'articles	prix en €
	Ecrou hexagonal					
	Acier à zingage électrolytique	M8	67020095	175	20307	0,18/pc.
	 100 pc.	M10	67020079	175	20307	0,21/pc.
	Ecrou hexagonal					
	Acier inoxydable AISI 304	M8	67060062	175	20307	1,12/pc.
	 100 pc.	M10	67060014	175	20307	2,56/pc.
	Rondelle					
	Acier à zingage électrolytique	M8	67020083	176	20307	0,08/pc.
	 100 pc.	M10	67020061	176	20307	0,21/pc.
	Rondelle					
	Acier inoxydable AISI 316L	M8	67060063	176	20307	0,57/pc.
	 100 pc.	M10	67060064	176	20307	0,83/pc.
	Rondelle étoilée					
	Acier inoxydable	M8	67020084	176	20307	0,27/pc.
	 100 pc.					
	Rondelle étoilée					
	Acier inoxydable	M10	67020086	176	20307	0,36/pc.
	 100 pc.					
	Tige filetée					
	Acier à zingage électrolytique	M6	67010140	148	20307	3,04/pc.
	↔ 0,5 m					
	Tige filetée					
Acier inoxydable AISI 316L	M8	67060044	148	20307	29,37/pc.	
↔ 0,5 m						
Tige filetée						
Acier à zingage électrolytique	M6	67010141	148	20307	3,90/m	
↔ 1 m						
Tige filetée						
Acier inoxydable AISI 316L	M8	67060045	148	20307	38,34/m	
↔ 1 m	M10	67060145	148	20307	48,11/m	



Systemes de support de câbles en matière composite



Le polyester renforcé de fibres de verre (Glass Reinforced Polymer) offre une excellente résistance au feu et à la corrosion. En outre, il ne subit aucune modification en cas de variations de température ou de conditions climatiques défavorables et la gamme est stable aux UV. C'est pourquoi le polyester renforcé de fibres de verre est la solution la plus rentable à long terme.

Notre gamme de produits renforcés de fibres de verre se compose de gaines (fermées) et d'échelles à câbles. De plus, nous proposons ces systèmes dans une gamme étendue de résines, en fonction de l'utilisation prévue.

Application:

- Chemins de fer
- Exploitation pétrolière et gazière
- Pétrochimie
- Navigation
- Tunnels
- Traitement des déchets



	<p>Gaine à câbles (fermée)</p> <p>Hauteur : 60 - 110 mm Largeur : 100 - 150 - 200 - 300 - 400 mm Longueur : 3000 mm</p>
	<p>Echelles à câbles</p> <p>Hauteur : 100 - 150 mm Largeur : 150 jusqu'à 1000 mm Longueur : 3000 - 6000 mm</p>
	<p>Profilés</p> <p>Dimensions : 41,5 x 41,5 mm 85 x 43,5 mm (double) Longueur : 3000 mm</p>



reijiband[®] treillis à câbles

Gamme étendue des exécutions et traitements de surface

- ✓ zingage électrolytique
- ✓ zingage électrolytique, bichromaté
- ✓ galvanisation Sendzimir
- ✓ Black C8, Résistance Haute Protection, CLASS 8 IEC 61537
- ✓ acier inoxydable AISI 304 ou AISI 316

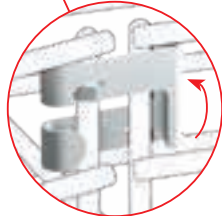
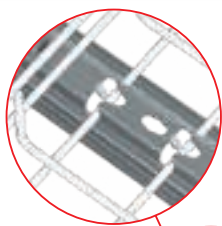

Système CLICK

- ✓ consoles et accessoires

Embouts de sécurité

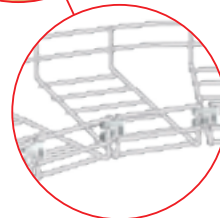
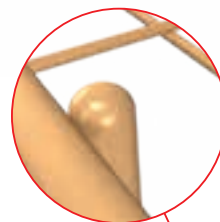

Système simple

- ✓ système à couper, courber et connecter
- ✓ gain de temps et de montage
- ✓ nombre d'accessoires limité

reijiband[®] RAPIDE





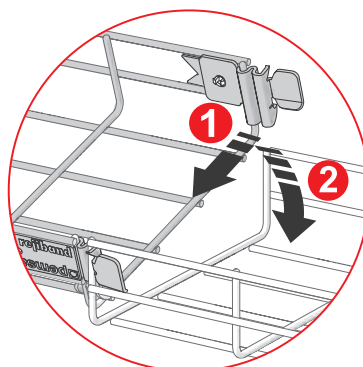
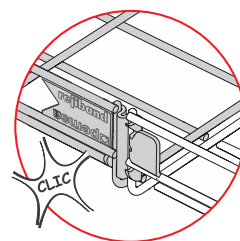

NEW

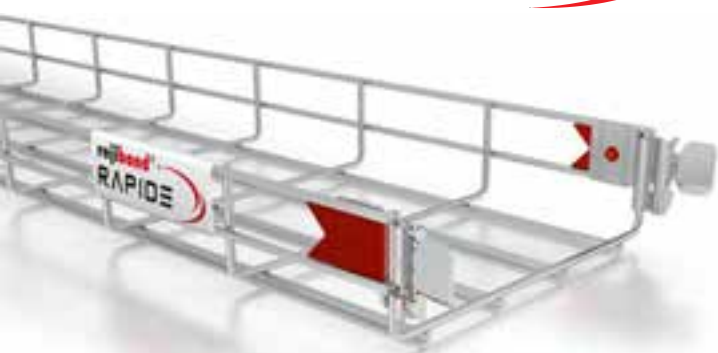
Seulement en 2 clics

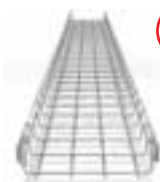

Le système le plus rapide



rejiband®		rejitech®	
rejiband® rapide	rejiband®	rejitech® rejitech G+®	treillis angulaire
 		 	

Caractéristiques				
E.Z.	H60/100	H35	H60/100	
Z.B.	H60/100	H35	H60/100	H60
H.D.		H35/60/100	H60/100	H60
C8	H60/100	H35	H60/100	
INOX 304		H35/60/100		H60
 mm	60-600	60-600	60-200	109
 mm	60-100	35/60/100	60-100	60
L mm	3000	3000	2000-3000	3000
 N/m				
	E90	E90		
Applications				
 Tertiaire	✓	✓	✓	✓
 Tunnels	✓	✓		
 Centres de données	✓	✓	✓	✓
 Installations PV	✓	✓		
 Industrie alimentaire	✓	✓		
 Pétrochimie	✓	✓		
 E.Z.	-	-	page 112	-
 Z.B.	page 96	page 93-95	page 112	page 113
 H.D.	-	page 93-95	-	page 113
 C8	-	-	-	-
 INOX 304	-	page 93-95	-	page 113

E.Z. zingage électrolytique NBN EN ISO 2081 – recommandé dans les environnements corrosifs C1 (très faible)
Z.B. zingage électrolytique, bichromaté NBN EN ISO 2081 – recommandé dans les environnements corrosifs C2 (faible)
H.D. galvanisation à chaud NBN EN ISO 1461 – recommandé dans les environnements corrosifs C3/C4 (moyen/haut)
C8 Black C8, Protection Haute Résistance, recommandé dans les environnements corrosifs C5-I (très haut – industrie)
INOX 304 acier inoxydable AISI 304 – recommandé dans les environnements corrosifs C5-I (très haut – industrie)

 voir page 4

Treillis à câbles

rejiband[®] 60x60-2

avec double fil

NEW



fixation spéciale



Installation facile



Charge élevée



Possibilités pour fixer

Fixation directe

Sur chaque type de support ou structure grâce au kit de fixation.

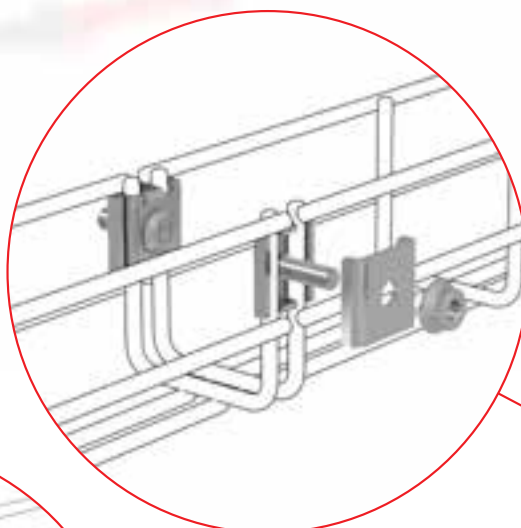

Accouplement renforcé

Pour un accouplement solide.

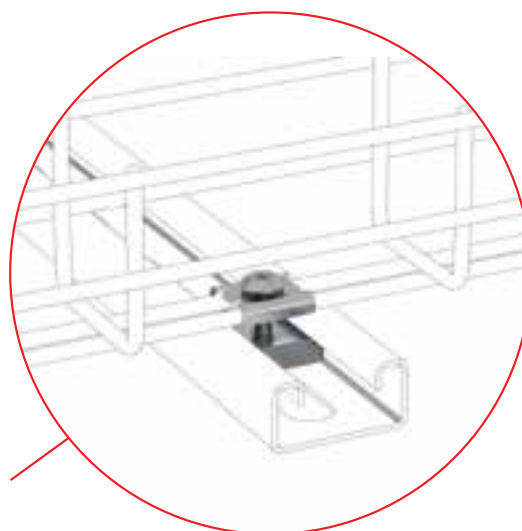
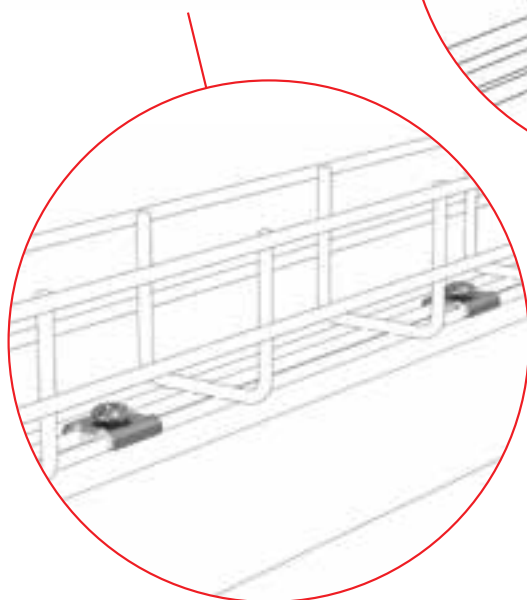

Fixation très simple sur un profilé avec un écrou coulissant

Le boulon à tête cruciforme et éclipse de branchement se vissent dans le boulon coulissant.

Treillis à câbles

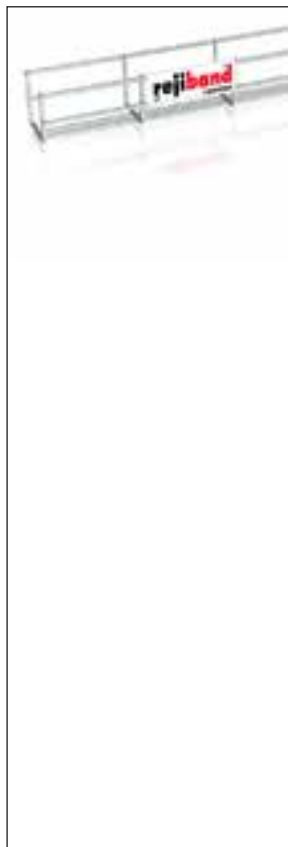

Treillis à câbles Rejiband 60 avec deux fils dans le fond

type	référence	stock	page. catal.	groupe d'articles	prix en €
Acier à zingage électrolytique	60 x 60-2 60212065		026	20304	9,39/m
↔ 3 m  18 m					

Treillis à câbles Rejiband 60 avec deux fils dans le fond

Acier à zingage électrolytique, bichromaté	60 x 60-2 60222065		026	20301	10,42/m
↔ 3 m  18 m					

Treillis à câbles Rejiband 60 avec deux fils dans le fond

Acier galvanisé à chaud	60 x 60-2 60232065	✓	026	20305	15,56/m
↔ 3 m  18 m					

Treillis à câbles Rejiband 60 avec deux fils dans le fond

Black C8	60 x 60-2 60282065		026	20306	13,72/m
↔ 3 m  18 m					

Treillis à câbles Rejiband 60 avec deux fils dans le fond

Acier inoxydable AISI 304	60 x 60-2 60252065	✓	026	20302	50,97/m
↔ 3 m  18 m					

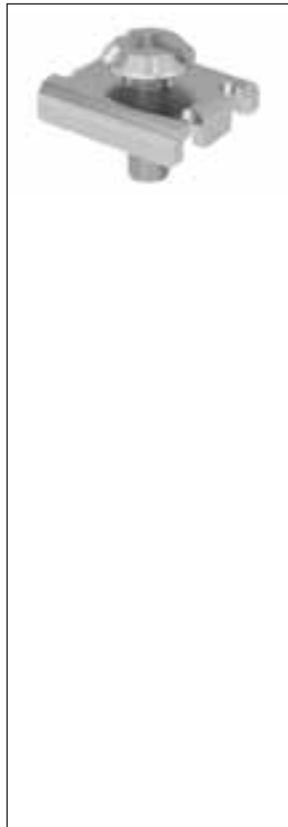

Accouplement pour les deux fils dans le fond

Acier à zingage électrolytique	60-2 64010058	✓	026	20307	0,75/pc.
 25 pc.					

Accouplement pour les deux fils dans le fond

Acier à zingage électrolytique, bichromaté	60-2 64020058		026	20307	0,81/pc.
 25 pc.					

Accouplement pour les deux fils dans le fond

Lamellar zinc	60-2 64030058	✓	026	20307	1,02/pc.
 25 pc.					

Accouplement pour les deux fils dans le fond

Black C8	60-2 64080058	✓	026	20307	1,04/pc.
 25 pc.					

Accouplement pour les deux fils dans le fond

Acier inoxydable AISI 316L	60-2 64060058		026	20307	2,92/pc.
 25 pc.					

NEW

rejiband® RAPIDE

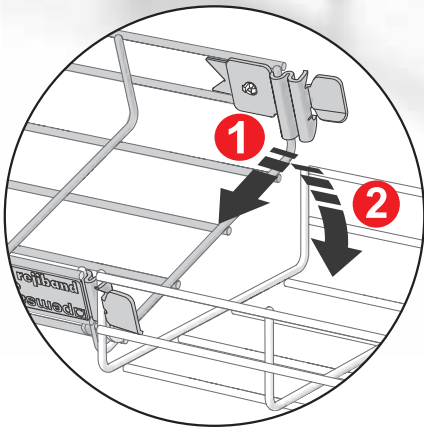
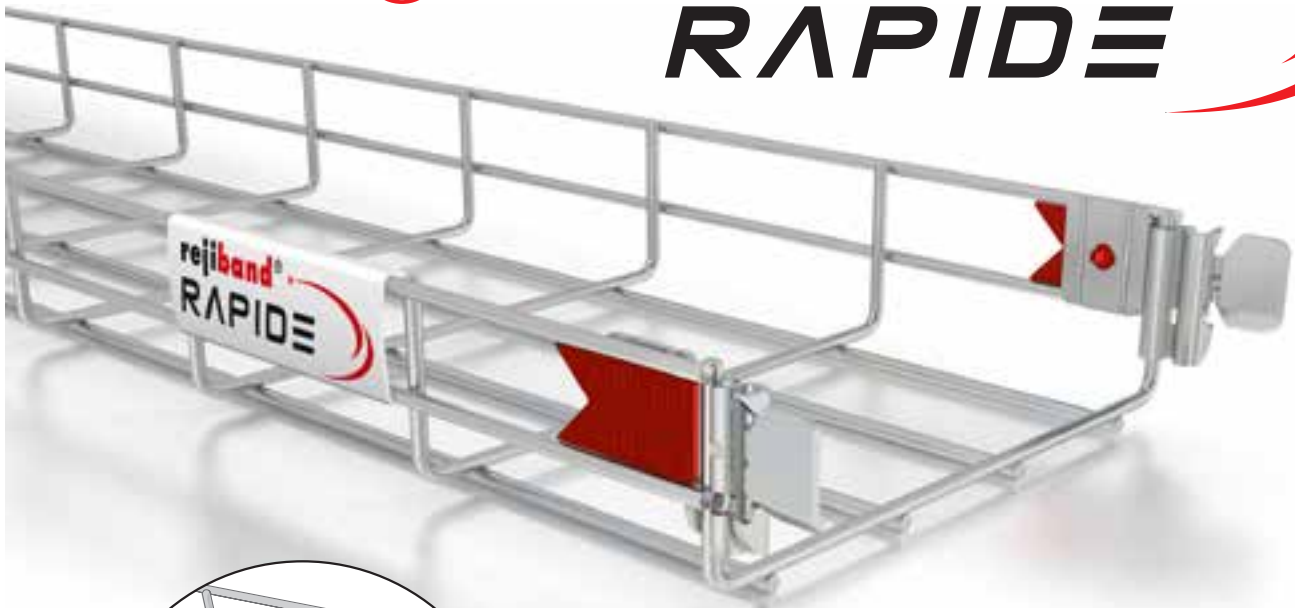

**Seulement
en 2 clicks**

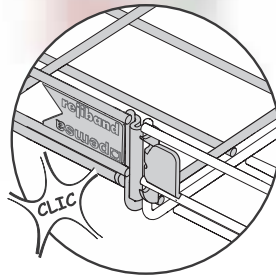

**Le système le
plus rapide**

Gain de temps & de main d'oeuvre, installation rapide

ASSEMBLAGE VERTICAL

MONTAGE BASCULANT

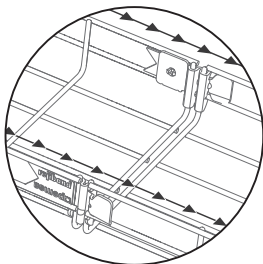

Continuité électrique
selon la norme

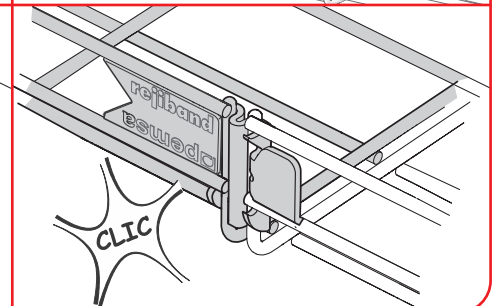
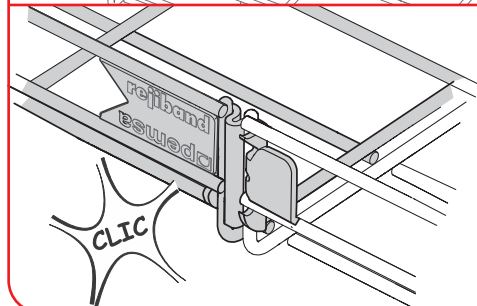
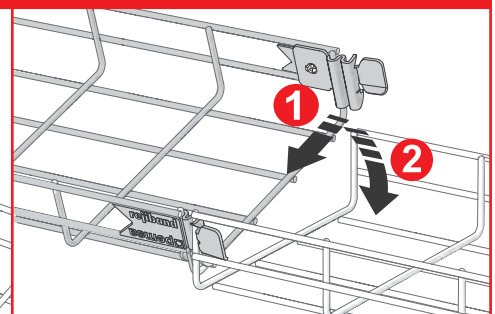
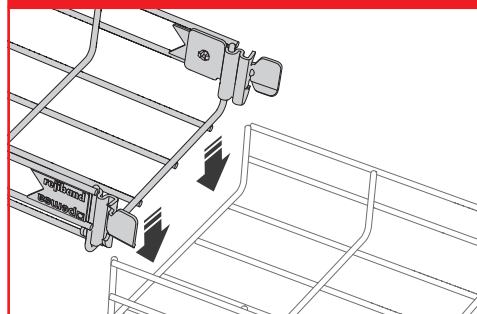

Treillis à câbles



type	référence	stock	page. catal.	groupe d'articles	prix en €
------	-----------	-------	--------------	-------------------	-----------

Treillis à câbles Rejiband RAPIDE 60

Acier à zingage électrolytique

↔ 3 m	18 m	60 x 60-2	60512060	✓	020	20304	9,28/m
	24 m	60 x 100 60 x 150	60512100 60512150	✓ ✓	020 020	20304 20304	11,75/m 14,39/m
	18 m	60 x 200	60512200	✓	020	20304	16,20/m
	12 m	60 x 300	60512300	✓	020	20304	21,00/m
	6 m	60 x 400 60 x 500 60 x 600	60512400 60512500 60512600	✓ ✓ ✓	020 020 020	20304 20304 20304	30,06/m 37,03/m 43,77/m

Treillis à câbles Rejiband RAPIDE 60

Acier à zingage électrolytique, bichromaté

↔ 3 m	18 m	60 x 60-2	60522060	✓	020	20301	10,12/m
	24 m	60 x 100 60 x 150	60522100 60522150	✓ ✓	020 020	20301 20301	13,02/m 15,95/m
	18 m	60 x 200	60522200	✓	020	20301	17,98/m
	12 m	60 x 300	60522300	✓	020	20301	23,22/m
	6 m	60 x 400 60 x 500 60 x 600	60522400 60522500 60522600	✓	020 020 020	20301 20301 20301	33,13/m 41,07/m 48,33/m

Treillis à câbles Rejiband RAPIDE 60

Black C8

↔ 3 m	18 m	60 x 60-2	60582060	✓	020	20306	13,72/m
	24 m	60 x 100 60 x 150	60582100 60582150	✓ ✓	020 020	20306 20306	15,81/m 19,53/m
	18 m	60 x 200	60582200	✓	020	20306	23,12/m
	12 m	60 x 300	60582300	✓	020	20306	31,60/m
	6 m	60 x 400 60 x 500 60 x 600	60582400 60582500 60582600	✓	020 020 020	20306 20306 20306	41,74/m 49,22/m 58,09/m

Accouplement latéral pour treillis à câbles Rejiband RAPIDE

Acier à zingage électrolytique	4	64010038	✓	028	20307	2,71/pc.
20 pc.	5	64010040	✓	028	20307	2,71/pc.

Accouplement latéral pour treillis à câbles Rejiband RAPIDE

Acier à zingage électrolytique, bichromaté	4	64020038	✓	028	20307	3,00/pc.
20 pc.	5	64020040	✓	028	20307	3,00/pc.

Accouplement latéral pour treillis à câbles Rejiband RAPIDE

Black C8	4	64080038		028	20307	4,30/pc.
20 pc.	5	64080040		028	20307	4,30/pc.

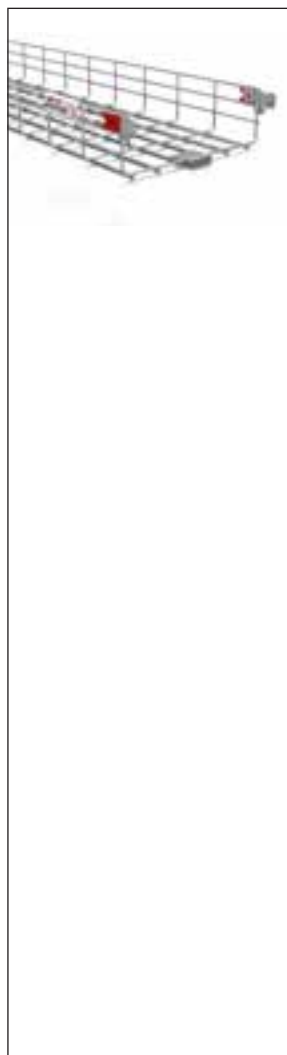

Treillis à câbles



type	référence	stock	page. catal.	groupe d'articles	prix en €
------	-----------	-------	--------------	-------------------	-----------



Treillis à câbles Rejiband RAPIDE 100

Acier à zingage électrolytique

↔ 3 m		12 m	100 x 100	60513100	020	20304	22,38/m
			100 x 150	60513150	020	20304	27,39/m
			100 x 200	60513200	020	20304	29,71/m
	6 m		100 x 300	60513300	020	20304	35,71/m
			100 x 400	60513400	020	20304	46,49/m
			100 x 500	60513500	020	20304	55,25/m
			100 x 600	60513600	020	20304	56,22/m



Treillis à câbles Rejiband RAPIDE 100

Acier à zingage électrolytique, bichromaté

↔ 3 m		12 m	100 x 100	60523100	020	20301	22,90/m
			100 x 150	60523150	020	20301	28,00/m
			100 x 200	60523200	020	20301	30,49/m
	6 m		100 x 300	60523300	020	20301	36,49/m
			100 x 400	60523400	020	20301	47,51/m
			100 x 500	60523500	020	20301	57,31/m
			100 x 600	60523600	020	20301	58,37/m

Treillis à câbles Rejiband RAPIDE 100

Black C8

↔ 3 m		12 m	100 x 100	60583100	020	20306	25,16/m
			100 x 150	60583150	020	20306	28,50/m
			100 x 200	60583200	020	20306	35,82/m
	6 m		100 x 300	60583300	020	20306	46,12/m
			100 x 400	60583400	020	20306	56,49/m
			100 x 500	60583500	020	20306	73,17/m
			100 x 600	60583600	020	20306	79,41/m

Accouplement de fond pour treillis à câbles Rejiband RAPIDE

Acier à zingage électrolytique	4	64010046	✓	030	20307	4,07/pc.
 20 pc.	5	64010048	✓	030	20307	4,07/pc.

Accouplement de fond pour treillis à câbles Rejiband RAPIDE

Acier à zingage électrolytique,	4	64020046	✓	030	20307	4,43/pc.
bichromaté	5	64020048	✓	030	20307	4,43/pc.
 20 pc.						

Accouplement de fond pour treillis à câbles Rejiband RAPIDE

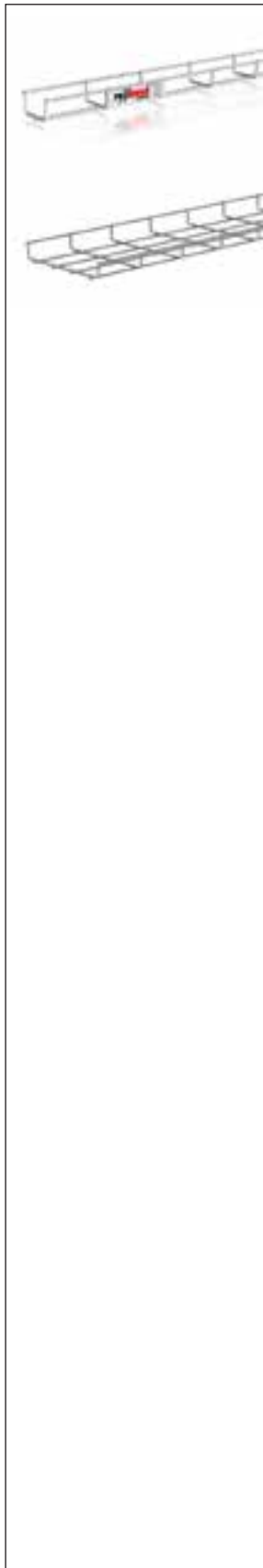

Black C8	4	64080046		030	20307	6,14/pc.
 20 pc.	5	64080048		030	20307	6,14/pc.

Trellis à câbles





Trellis à câbles Rejiband 35

Acier à zingage électrolytique

	type	référence	stock	page. catal.	groupe d'articles	prix en €	
↔ 3 m	 24 m	35 x 60	60211060	✓	024	20304	9,42/m
		35 x 100	60211100	✓	024	20304	9,71/m
		35 x 150	60211150		024	20304	13,64/m
 18 m		35 x 200	60211200	✓	024	20304	14,92/m
		35 x 300	60211300		024	20304	21,41/m
 12 m		35 x 400	60211400		024	20304	26,84/m



Trellis à câbles Rejiband 35

Acier à zingage électrolytique, bichromaté

↔ 3 m	 24 m	35 x 60	60221060	✓	024	20301	9,76/m
		35 x 100	60221100	✓	024	20301	10,06/m
		35 x 150	60221150		024	20301	14,13/m
 18 m		35 x 200	60221200	✓	024	20301	15,45/m
		35 x 300	60221300	✓	024	20301	22,18/m
 12 m		35 x 400	60221400		024	20301	27,82/m



Trellis à câbles Rejiband 35

Acier galvanisé à chaud

↔ 3 m	 24 m	35 x 60	60231060	✓	024	20305	11,70/m
		35 x 100	60231100	✓	024	20305	12,94/m
		35 x 150	60231150		024	20305	16,74/m
 18 m		35 x 200	60231200		024	20305	19,01/m
		35 x 300	60231300		024	20305	26,32/m
 12 m		35 x 400	60231400		024	20305	31,30/m



Trellis à câbles Rejiband 35

Black C8

↔ 3 m	 24 m	35 x 60	60281060	✓	024	20306	10,30/m
		35 x 100	60281100	✓	024	20306	11,40/m
		35 x 150	60281150		024	20306	14,72/m
 18 m		35 x 200	60281200	✓	024	20306	16,74/m
		35 x 300	60281300		024	20306	23,15/m
 12 m		35 x 400	60281400		024	20306	27,55/m

Trellis à câbles Rejiband 35

Acier inoxydable AISI 304

↔ 3 m	 24 m	35 x 60	60251060	✓	024	20302	32,18/m
		35 x 100	60251100	✓	024	20302	38,34/m
		35 x 150	60251150		024	20302	45,64/m
 18 m		35 x 200	60251200		024	20302	59,07/m
		35 x 300	60251300		024	20302	78,10/m
 12 m		35 x 400	60251400		024	20302	117,09/m

Treillis à câbles

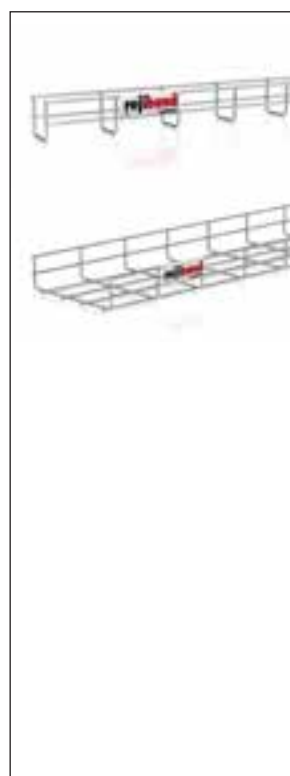

Treillis à câbles Rejiband 60

	type	référence	stock	page. catal.	groupe d'articles	prix en €			
←→ 3 m	Acier galvanisé à chaud	60 x 60	60232060	✓	024	20305	13,25/m		
		60 x 100	60232100	✓	024	20305	17,92/m		
		60 x 150	60232150	✓	024	20305	22,18/m		
	18 m	60 x 200	60232200	✓	024	20305	26,26/m		
			12 m	60 x 300	60232300	✓	024	20305	35,92/m
					6 m	60 x 400	60232400	✓	024
	60 x 500	60232500		024			20305	55,94/m	
		60 x 600	60232600				024	20305	66,02/m

Treillis à câbles Rejiband 60

	type	référence	stock	page. catal.	groupe d'articles	prix en €			
←→ 3 m	Acier inoxydable AISI 304	60 x 60	60252060	✓	024	20302	38,70/m		
		60 x 100	60252100	✓	024	20302	52,71/m		
		60 x 150	60252150	✓	024	20302	62,44/m		
	18 m	60 x 200	60252200	✓	024	20302	71,90/m		
			12 m	60 x 300	60252300	✓	024	20302	90,88/m
					6 m	60 x 400	60252400	✓	024
	60 x 500	60252500		024			20302	134,42/m	
		60 x 600	60252600				024	20302	152,75/m

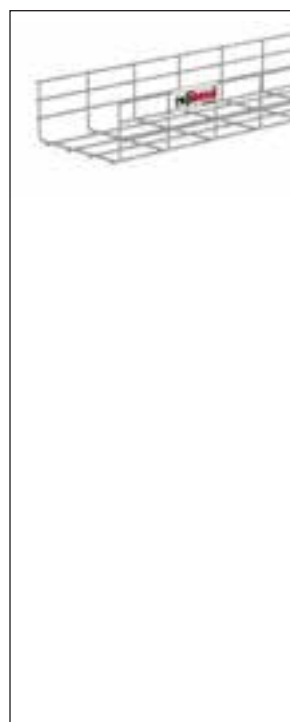

Treillis à câbles Rejiband 100

	type	référence	stock	page. catal.	groupe d'articles	prix en €			
←→ 3 m	Acier galvanisé à chaud	12 m	100 x 100	60233100	024	20305	28,26/m		
				6 m	100 x 150	60233150	024	20305	31,41/m
						100 x 200	60233200	024	20305
		100 x 300	60233300			024	20305	52,25/m	
		100 x 400	60233400			024	20305	63,75/m	
		100 x 500	60233500			024	20305	74,37/m	
		100 x 600	60233600			024	20305	79,41/m	

Treillis à câbles Rejiband 100

	type	référence	stock	page. catal.	groupe d'articles	prix en €			
←→ 3 m	Acier inoxydable AISI 304	12 m	100 x 100	60253100	024	20302	66,19/m		
				6 m	100 x 150	60253150	024	20302	74,58/m
						100 x 200	60253200	024	20302
		100 x 300	60253300			024	20302	113,77/m	
		100 x 400	60253400			024	20302	133,57/m	
		100 x 500	60253500			024	20302	155,05/m	
		100 x 600	60253600			024	20302	173,69/m	

Treillis à câbles



Accouplement renforcé 61

Acier à zingage électrolytique 64010061 ✓ 028 20307 1,61/pc.
 50 pc.

Accouplement renforcé 61

Acier à zingage électrolytique, bichromaté 64020061 ✓ 028 20307 1,61/pc.
 50 pc.

Accouplement renforcé 61

Lamellar zinc 64030061 ✓ 028 20307 2,27/pc.
 50 pc.

Accouplement renforcé 61

Black C8 64080061 ✓ 028 20307 2,27/pc.
 50 pc.

Accouplement renforcé 61

Acier inoxydable AISI 316L 64060061 ✓ 028 20307 6,61/pc.
 50 pc.



Accouplement Click

Acier à zingage électrolytique 64010035 028 20307 2,40/pc.
 50 pc.

Accouplement Click

Acier à zingage électrolytique, bichromaté 64020035 028 20307 2,40/pc.
 50 pc.





Accouplement Click

Lamellar zinc 64030035 ✓ 028 20307 3,37/pc.
 50 pc.

Accouplement Click

Black C8 64080035 028 20307 3,37/pc.
 50 pc.

















Treillis à câbles

	type	référence	 stock	page. catal.	groupe d'articles	prix en €
	Accouplement de fond Click					
	Acier à zingage électrolytique	64010036		028	20307	3,43/pc.
	 10 pc.					
	Accouplement de fond Click					
	Acier à zingage électrolytique, bichromaté	64020036		028	20307	3,43/pc.
	 10 pc.					
	Accouplement de fond Click					
	Lamellar zinc	64030036		028	20307	4,80/pc.
 10 pc.						
Accouplement de fond Click						
	Black C8	64080036		028	20307	4,80/pc.
	 10 pc.					
	Accouplement Click					
	Acier à zingage électrolytique	64010020		028	20307	4,28/pc.
 25 pc.						
Accouplement Click						
Acier à zingage électrolytique, bichromaté	64020030		028	20307	4,28/pc.	
 25 pc.						
Accouplement Click						
Lamellar zinc	64030030		028	20307	5,11/pc.	
 25 pc.						
Accouplement Click						
Black C8	64080030		028	20307	5,11/pc.	
 25 pc.						
Accouplement au flanc 41						
Acier à zingage électrolytique	64010041		030	20307	1,52/pc.	
 50 pc.						
Accouplement au flanc 41						
Acier à zingage électrolytique, bichromaté	64020041		030	20307	1,52/pc.	
 50 pc.						
Accouplement au flanc 41						
Lamellar zinc	64030041		030	20307	2,41/pc.	
 50 pc.						
Accouplement au flanc 41						
Black C8	64080041		030	20307	2,41/pc.	
 50 pc.						
Accouplement au flanc 41						
Acier inoxydable AISI 316L	64060041		030	20307	8,28/pc.	
 50 pc.						

Treillis à câbles

	type	référence	 stock	page. catal.	groupe d'articles	prix en €
	Multi-éclisse					
	Acier à zingage électrolytique	L = 300 mm 67010053	✓	030	20307	4,66/pc.
	 10 pc.					
	Multi-éclisse					
	Acier à zingage électrolytique, bichromaté	L = 300 mm 67020053	✓	030	20307	4,66/pc.
 10 pc.						
Multi-éclisse						
Lamellar zinc	L = 300 mm 67030047	✓	030	20307	7,48/pc.	
 10 pc.						
Multi-éclisse						
Black C8	L = 300 mm 67080053	✓	030	20307	7,48/pc.	
 10 pc.						
Multi-éclisse						
Acier inoxydable AISI 316L	L = 300 mm 67060053		030	20307	13,80/pc.	
 10 pc.						
	Borne de terre					
	Laiton	16-35 mm ² 68000032	✓	032	20307	9,80/pc.
 20 pc.						
	Borne de terre					
	Laiton	35-45 mm ² 68000033		032	20307	55,45/pc.
 20 pc.						
	Borne de terre					
	Laiton	16-50 mm ² 68000034 50-110 mm ² 68000035	✓	032 032	20309 20309	6,11/pc. 12,27/pc.
 20 pc.						

Treillis à câbles

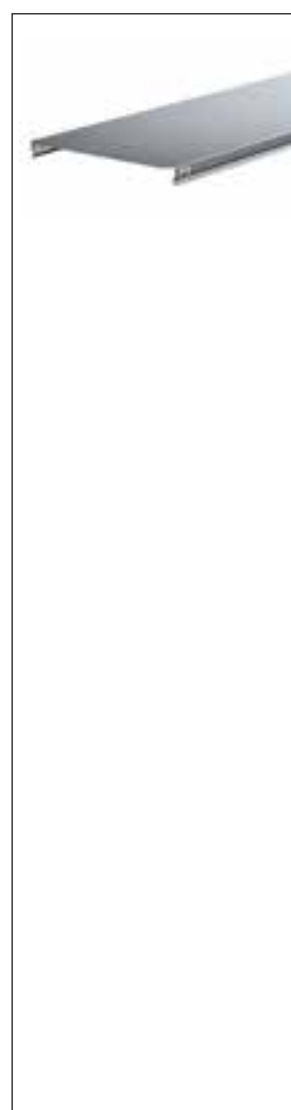

	type	référence	 stock	page. catal.	groupe d'articles	prix en €
	Accouplement 60					
	Acier à zingage électrolytique	64010060	✓	030	20307	1,18/pc.
	 50 pc.					
	Accouplement 60					
	Acier à zingage électrolytique, bichromaté	64020060	✓	030	20307	1,18/pc.
	 50 pc.					
	Accouplement 60					
	Lamellar zinc	64030060	✓	030	20307	1,78/pc.
	 50 pc.					
	Accouplement 60					
	Black C8	64080060	✓	030	20307	1,78/pc.
	 50 pc.					
	Accouplement 60					
	Acier inoxydable AISI 316L	64060060	✓	030	20307	4,53/pc.
	 50 pc.					
	Plaque d'accouplement 62					
	Acier à zingage électrolytique	64010062	✓	032	20307	0,64/pc.
	 50 pc.					
	Plaque d'accouplement 62					
	Acier à zingage électrolytique, bichromaté	64020062	✓	032	20307	0,64/pc.
	 50 pc.					
	Plaque d'accouplement 62					
	Lamellar zinc	64030062	✓	032	20307	0,67/pc.
	 50 pc.					
	Plaque d'accouplement 62					
	Acier inoxydable AISI 316L	64060062	✓	032	20307	2,37/pc.
	 50 pc.					
	Accouplement courbe Click					
	Acier à zingage électrolytique	64010072		030	20307	1,46/pc.
	 50 pc.					
	Accouplement courbe Click					
	Acier à zingage électrolytique, bichromaté	64020072		030	20307	1,46/pc.
	 50 pc.					
	Accouplement courbe Click					
	Lamellar zinc	64030072		030	20307	2,01/pc.
	 50 pc.					
	Accouplement courbe Click					
	Black C8	64080072		030	20307	2,01/pc.
 50 pc.						

Treillis à câbles





Couvercle Click

Acier galvanisé Sendzimir

	type	référence	stock	page. catal.	groupe d'articles	prix en €	
↔ 3 m	 24 m	60	73021060	✓	034	20316	7,27/m
		100	73021100	✓	034	20316	9,39/m
	 12 m	150	73021150	✓	034	20316	12,17/m
		200	73021200	✓	034	20316	14,82/m
	 6 m	300	73021300	✓	034	20316	22,59/m
		400	73021400		034	20316	28,94/m
		500	73021500		034	20316	39,21/m
		600	73021600		034	20316	46,01/m



Couvercle Click

Acier galvanisé à chaud

↔ 3 m	 24 m	60	73031060	✓	034	20316	12,19/m
		100	73031100	✓	034	20316	17,01/m
	 12 m	150	73031150	✓	034	20316	23,12/m
		200	73031200	✓	034	20316	29,25/m
	 6 m	300	73031300	✓	034	20316	44,49/m
		400	73031400		034	20316	57,61/m
		450	73031450		034	20316	72,07/m
		500	73031500		034	20316	70,73/m
		600	73031600		034	20316	83,86/m

Couvercle Click

Acier inoxydable AISI 304

↔ 3 m	 24 m	60	73051060	✓	034	20316	30,63/m
		100	73051100	✓	034	20316	43,28/m
	 12 m	150	73051150	✓	034	20316	57,74/m
		200	73051200	✓	034	20316	70,70/m
	 6 m	300	73051300	✓	034	20316	98,82/m
		400	73051400		034	20316	127,57/m
		500	73051500		034	20316	138,82/m
		600	73051600		034	20316	190,38/m

Cloison de séparation H = 25 mm

Acier galvanisé Sendzimir

↔ 3 m	 60 m	67020610	✓	032	20316	7,24/m
-------	--	----------	---	-----	-------	--------

Cloison de séparation H = 25 mm

Acier galvanisé à chaud

















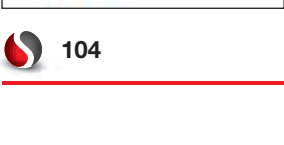

↔ 3 m	 60 m	67030610	✓	032	20316	9,94/m
-------	--	----------	---	-----	-------	--------

Cloison de séparation H = 25 mm

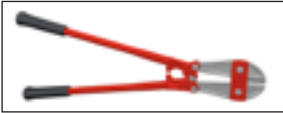
Acier inoxydable AISI 304

↔ 3 m	 60 m	67050610		032	20316	25,46/m
-------	--	----------	--	-----	-------	---------







Treillis à câbles

	type	référence	 stock	page. catal.	groupe d'articles	prix en €
	Cloison de séparation, H = 50 mm					
	Acier galvanisé Sendzimir	67020611	✓	032	20316	8,14/m
	↔ 3 m  48 m					
	Cloison de séparation, H = 50 mm					
	Acier galvanisé à chaud	67030611	✓	032	20316	13,49/m
	↔ 3 m  48 m					
	Cloison de séparation, H = 50 mm					
	Acier inoxydable AISI 304	67050611		032	20316	34,71/m
	↔ 3 m  48 m					
	Cloison de séparation, H = 80 mm					
	Acier galvanisé Sendzimir	67020612		032	20316	14,31/m
	↔ 3 m  36 m					
	Cloison de séparation, H = 80 mm					
	Acier galvanisé à chaud	67030612		032	20316	19,00/m
	↔ 3 m  36 m					
	Cloison de séparation, H = 80 mm					
	Acier inoxydable AISI 304	67050612		032	20316	47,22/m
	↔ 3 m  36 m					
	Plaque d'identification					
	Matière synthétique rouge	68000020		034	20307	1,21/pc.
	 50 pc.					
	Cisaille pour treillis à câbles					
	450x140	68000058	✓	036	20307	324,53/pc.
	Embout de finition					
	Matière synthétique noir	68000049	✓	036	20307	0,47/pc.
	 100 pc.					
	Galvanospray 0,4l					
	Zinc	68000052	✓	036	20307	59,04/pc.
	Galvanospray 0,4l					
	Black C8	68000053	✓	036	20307	101,53/pc.
	Support pour boîte de montage					
	Matière synthétique rouge	68000040		036	20307	1,47/pc.
	 20 pc.					









Treillis à câbles

	type	référence	stock	page. catal.	groupe d'articles	prix en €	
	Etrier pour éclairage ou boîte de distribution						
	Acier à zingage électrolytique	67010030		038	20307	8,91/pc.	
	 10 pc.						
	Etrier pour éclairage ou boîte de distribution						
	Acier à zingage électrolytique, bichromaté	67020030		038	20307	8,91/pc.	
	 10 pc.						
	Etrier pour éclairage ou boîte de distribution						
	Lamellar zinc	67030030		038	20307	9,80/pc.	
	 10 pc.						
	Etrier pour éclairage ou boîte de distribution						
	Black C8	67080030		038	20307	9,80/pc.	
	 10 pc.						
	Bande auto-adhésive Rejifix						
	ABS noir	68000002		040	20307	146,00/pc.	
	1 pc. = 25 m						
	Support pour câbles						
	ABS rouge	68000010		038	20307	2,10/pc.	
	 20 pc.						
	Plaquette d'identification						
	Polypropylène	69000400		040	20307	1,35/pc.	
	 20 pc.						
	Mini-support universel						
	Acier galvanisé Sendzimir	87x65	62026010	✓	038	20307	3,39/pc.
	 10 pc.						
	Mini-support universel						
	Lamellar zinc	87x65	62036010	✓	038	20307	7,27/pc.
	 10 pc.						
	Mini-support universel						
	Black C8	87x65	62086010	✓	038	20307	7,27/pc.
 10 pc.							
Mini-support universel							
Acier inoxydable AISI 316L	87x65	62066010	✓	038	20307	12,87/pc.	
 10 pc.							

Treillis à câbles

	type	référence	 stock	page. catal.	groupe d'articles	prix en €	
	Plaque de montage						
	Acier galvanisé Sendzimir	109x170	62026011	✓	038	20307	6,31/pc.
	 10 pc.						
	Plaque de montage						
	Lamellar zinc	109x170	62036011	✓	038	20307	11,09/pc.
	 10 pc.						
	Plaque de montage						
	Black C8	109x170	62086011		038	20307	11,09/pc.
 10 pc.							
	Plaque de montage						
	Acier inoxydable AISI 316L	109x170	62066011		038	20307	26,97/pc.
	 10 pc.						
	Sortie pour câbles optiques						
	Matière synthétique rouge		67020039	✓	040	20307	4,37/pc.
	 10 pc.						
	Sortie pour câbles						
	Acier galvanisé Sendzimir		67010016		040	20307	8,06/pc.
	Sortie pour câbles						
	Acier galvanisé à chaud		67030016		040	20307	13,46/pc.
	Etrier avec sorties pour tubes						
	Acier à zingage électrolytique		67010040		040	20307	4,99/pc.
	 10 pc.						
	Etrier avec sorties pour tubes						
	Acier à zingage électrolytique, bichromaté		67020040		040	20307	4,99/pc.
	 10 pc.						
Etrier avec sorties pour tubes							
Black C8		67080040		040	20307	7,11/pc.	
 10 pc.							

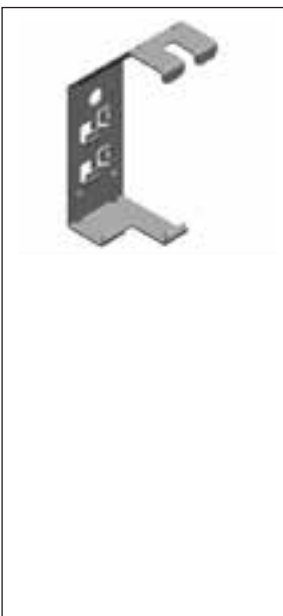













Treillis à câbles

	type	référence	stock	page. catal.	groupe d'articles	prix en €	
	Etrier avec 2 sorties de tubes						
	Acier à zingage électrolytique	M20, PG13, 1/2"	67010240	042	20307	5,22/pc.	
		M25, PG16, 3/4"	67010340	042	20307	5,22/pc.	
		M32, PG29, 1"	67010440	042	20307	5,22/pc.	
	 10 pc.						
	Etrier avec 2 sorties de tubes						
	Acier à zingage électrolytique, bichromaté	M20, PG13, 1/2"	67020240	042	20307	5,51/pc.	
		M25, PG16, 3/4"	67020340	042	20307	5,51/pc.	
		M32, PG29, 1"	67020440	042	20307	5,51/pc.	
	 10 pc.						
	Etrier avec 2 sorties de tubes						
	Black C8	M20, PG13, 1/2"	67080240	042	20307	6,31/pc.	
		M25, PG16, 3/4"	67080340	042	20307	6,31/pc.	
		M32, PG29, 1"	67080440	042	20307	6,31/pc.	
	 10 pc.						
	Etrier mural léger						
	Acier à zingage électrolytique		62016021	✓	042	20307	1,89/pc.
	 25 pc.						
	Etrier mural léger						
	Acier à zingage électrolytique, bichromaté		62026021	✓	042	20307	1,89/pc.
 25 pc.							
Etrier mural léger							
Lamellar zinc		62036021	✓	042	20307	3,15/pc.	
 25 pc.							
Etrier mural léger							
Black C8		62086021	✓	042	20307	3,15/pc.	
 25 pc.							
	Etrier de plafond léger						
	Acier à zingage électrolytique		62016020		042	20307	7,57/pc.
	 10 pc.						
	Etrier de plafond léger						
	Acier à zingage électrolytique, bichromaté		62026020	✓	042	20307	7,57/pc.
	 10 pc.						
	Etrier de plafond léger						
	Lamellar zinc		62036020		042	20307	11,27/pc.
	 10 pc.						
	Etrier de plafond léger						
Black C8		62086020		042	20307	11,27/pc.	
 10 pc.							

Treillis à câbles

	type	référence	 stock	page. catal.	groupe d'articles	prix en €
	Support de fond 60					
	Acier à zingage électrolytique	100x63	62016022		042 20307	6,24/pc.
	 10 pc.					
	Support de fond 60					
	Acier à zingage électrolytique, bichromaté	100x63	62026022		042 20307	6,24/pc.
 10 pc.						
Support de fond 60						
Lamellar zinc	100x63	62036022	✓	042 20307	8,31/pc.	
Support de fond 60						
Black C8	100x63	62086022		042 20307	8,31/pc.	
 10 pc.						
Support de fond 60						
Acier inoxydable AISI 316L	100x63	62066022		042 20307	16,38/pc.	
 10 pc.						
	Support pour flanc 60					
	Acier à zingage électrolytique	104x30	62011060	✓	044 20307	3,24/pc.
	 25 pc.					
	Support pour flanc 60					
	Acier à zingage électrolytique, bichromaté	104x30	62021060	✓	044 20307	3,24/pc.
	 25 pc.					
	Support pour flanc 60					
Lamellar zinc	104x30	62031060	✓	044 20307	4,35/pc.	
 25 pc.						
Support pour flanc 60						
Black C8	104x30	62081060	✓	044 20307	4,35/pc.	
 25 pc.						
Support pour flanc 60						
Acier inoxydable AISI 316L	104x30	62061060	✓	044 20307	7,79/pc.	
 25 pc.						
	Accouplement pour treillis / profilé					
	Lamellar zinc		67030049	✓	046 20307	2,64/pc.
 50 pc.						

Treillis à câbles

	type	référence	stock	page. catal.	groupe d'articles	prix en €	
	Suspension centrale Click						
	Acier à zingage électrolytique	M6	67010143	✓	044	20307	4,02/pc.
	 20 pc.	M8/M10	67010043	✓	044	20307	4,02/pc.
	Suspension centrale Click						
	Acier à zingage électrolytique, bichromaté	M6	67020143	✓	044	20307	4,02/pc.
	 20 pc.	M8/M10	67020043	✓	044	20307	4,02/pc.
	Suspension centrale Click						
	Lamellar zinc	M6	67030143		044	20307	5,01/pc.
	 20 pc.	M8/M10	67030043		044	20307	5,01/pc.
	Suspension centrale Click						
	Black C8	M6	67080143		044	20307	5,01/pc.
	 20 pc.	M8/M10	67080043	✓	044	20307	5,01/pc.
	Suspension centrale Click						
	Acier inoxydable AISI 316L	M6	67060143		044	20307	9,40/pc.
	 20 pc.	M8/M10	67060043	✓	044	20307	9,40/pc.
	Suspension centrale						
	Acier à zingage électrolytique	M6	67010144		044	20307	1,56/pc.
	 20 pc.	M8/M10	67010046	✓	044	20307	1,36/pc.
	Suspension centrale						
	Acier à zingage électrolytique, bichromaté	M8/M10	67020046	✓	044	20307	1,36/pc.
	 20 pc.						
	Suspension centrale						
	Lamellar zinc	M8/M10	67030046	✓	044	20307	2,32/pc.
	 20 pc.						
	Suspension centrale						
Black C8	M8/M10	67080046	✓	044	20307	2,32/pc.	
 20 pc.							
Suspension centrale							
Acier inoxydable AISI 316L	M8/M10	67060046	✓	044	20307	3,55/pc.	
 20 pc.							
	Accouplement pour treillis / profilé						
	Acier inoxydable AISI 316L		67060050		044	20307	3,81/pc.
 100 pc.							

Treillis à câbles

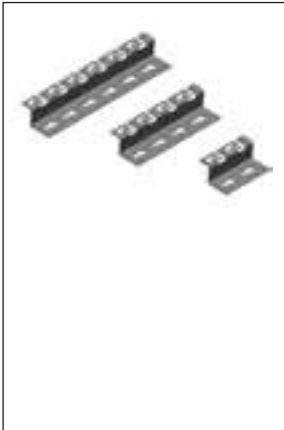
	type	référence	stock	page. catal.	groupe d'articles	prix en €	
	Pied d'appui						
	Matière synthétique rouge 100 pc. Hauteur 40 mm empilable.	68000060	✓	048	20307	3,08/pc.	
	Adhésif pour pied (2 x 4 kg)						
	Adhésif + durcisseur suffisant pour env. 400 pieds d'appui.	68000066		048	20307	342,44/pc.	
	Roofsupport						
	Matière synthétique/béton 1 set = 20 supports	60102011RSC	✓	-	20307	316,19/bt.	
	Distanceur						
	Acier galvanisé Sendzimir 10 pc.	180 350	67030539 67030540	✓ ✓	046 046	20307 20307	8,37/pc. 10,52/pc.
	Distanceur						
	Acier galvanisé à chaud 10 pc.	180 350	67030541 67030542	✓	046 046	20307 20307	14,84/pc. 17,06/pc.
	Distanceur						
	Acier inoxydable AISI 316L 10 pc.	180 350	67060541 67060542	✓	046 046	20307 20307	41,55/pc. 56,89/pc.
	RPLUS distanceur Click						
	Acier galvanisé Sendzimir 10 pc.	100 200 300	67020520 67020522 67020524	✓ ✓ ✓	046 046 046	20307 20307 20307	8,11/pc. 9,70/pc. 11,15/pc.
	RPLUS distanceur Click						
	Acier galvanisé à chaud 10 pc.	100 200 300	67030520 67030522 67030524	✓ ✓ ✓	046 046 046	20307 20307 20307	10,06/pc. 12,79/pc. 15,39/pc.
	RPLUS distanceur Click						
	Acier inoxydable AISI 304 10 pc.	100 200 300	67050520 67050522 67050524	✓ ✓ ✓	046 046 046	20307 20307 20307	12,54/pc. 20,69/pc. 28,48/pc.
	RPLUS100 distanceur Click						
	Acier inoxydable AISI 316L 10 pc.	100 200 300	67060560 67060562 67060564		046 046 046	20307 20307 20307	11,45/pc. 19,89/pc. 28,59/pc.

rejiband® BLACK C8®

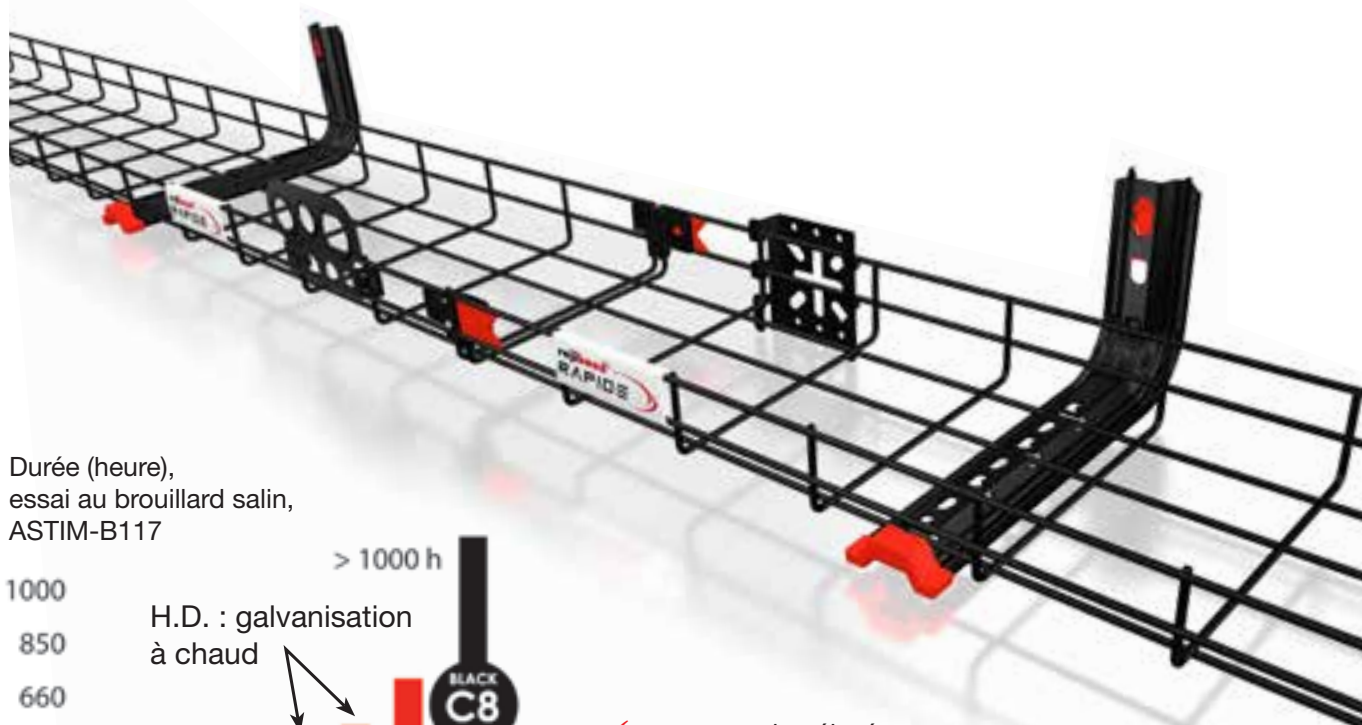

Durée (heure),
essai au brouillard salin,
ASTIM-B117

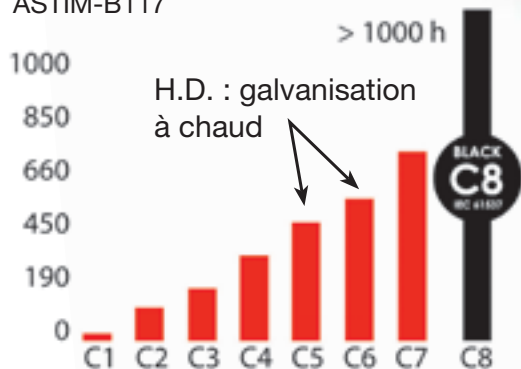

- ✓ une protection élevée contre la corrosion
- ✓ une finition esthétique de haute qualité – un revêtement lisse et régulier
- ✓ libre de membranes de zinc et de particules de zinc libres
- ✓ écologique

Trellis à câbles









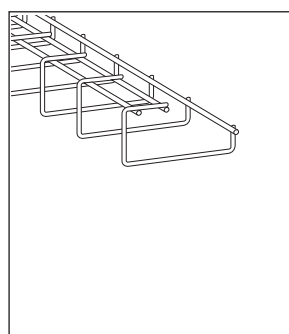





rejitech® G+













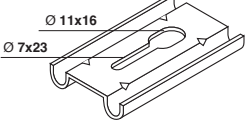

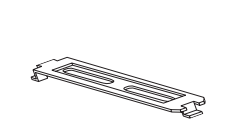
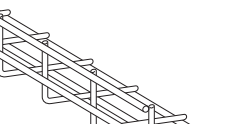

- ✓ installation rapide avec étrier
- ✓ directement au plafond
- ✓ pas besoin des étriers en C

Treillis de plafond et treillis angulaire

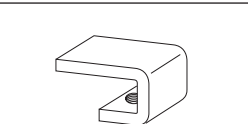

	type	référence	 stock	page. catal.	groupe d'articles	prix en €
Treillis de plafond Rejitech						
	Acier à zingage électrolytique 60 x 100	60215020	✓	050	20304	16,90/m
	↔ 2 m  16 m					
Treillis de plafond Rejitech						
	Acier à zingage électrolytique, bichromaté 60 x 100	60225020	✓	050	20301	17,51/m
	↔ 2 m  16 m					
Treillis de plafond Rejitech G+						
	Acier à zingage électrolytique					
	↔ 3 m  24 m	60 x 60 60613206	✓	052	20304	15,83/m
		100 x 60 60613306	✓	052	20304	18,54/m
	 12 m	100 x 100 60613310	✓	052	20304	23,12/m
	 6 m	100 x 150 60613315	✓	052	20304	25,14/m
		100 x 200 60613320	✓	052	20304	29,88/m
Treillis de plafond Rejitech G+						
	Acier à zingage électrolytique, bichromaté					
	↔ 3 m  24 m	60 x 60 60623206		052	20301	16,89/m
		100 x 60 60623306		052	20301	19,78/m
	 12 m	100 x 100 60623310		052	20301	24,68/m
	 6 m	100 x 150 60623315		052	20301	26,86/m
		100 x 200 60623320		052	20301	31,85/m
Treillis de plafond Rejitech G+						
	Acier galvanisé à chaud					
	↔ 3 m  24 m	60 x 60 60633206		052	20305	24,20/m
		100 x 60 60633306		052	20305	29,51/m
	 12 m	100 x 100 60633310		052	20305	34,81/m
	 6 m	100 x 150 60633315		052	20305	37,14/m
		100 x 200 60633320		052	20305	45,67/m
Treillis de plafond Rejitech G+						
	Black C8					
	↔ 3 m  24 m	60 x 60 60683206		052	20306	21,30/m
		100 x 60 60683306		052	20306	25,97/m
	 12 m	100 x 100 60683310	✓	052	20306	30,63/m
	 6 m	100 x 150 60683315		052	20306	32,64/m
		100 x 200 60683320		052	20306	40,20/m

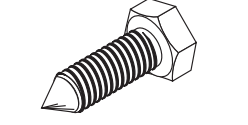
Treillis de plafond et treillis angulaire

	type	référence	 stock	page. catal.	groupe d'articles	prix en €	
	Etrier pour treillis de plafond Rejitech et Rejitech G+						
	Acier à zingage électrolytique	67010052	✓	052	20307	2,06/pc.	
	 25 pc.						
	Etrier pour treillis de plafond Rejitech et Rejitech G+						
	Acier à zingage électrolytique, bichromaté	67020052	✓	052	20307	2,06/pc.	
	 25 pc.						
	Etrier pour treillis de plafond Rejitech et Rejitech G+						
	Lamellar zinc	67030252	✓	052	20307	2,82/pc.	
	 25 pc.						
	Etrier pour treillis de plafond Rejitech et Rejitech G+						
	Black C8	67080252	✓	052	20307	2,82/pc.	
	 25 pc.						
	Support pour boîte de montage pour treillis de plafond Rejitech						
	Acier à zingage électrolytique, bichromaté	67020041	✓	050	20307	14,03/pc.	
	Treillis angulaire						
	Acier à zingage électrolytique, bichromaté	60 x 109	60220000	✓	053	20301	13,90/m
	↔ 3 m  18 m						
	Treillis angulaire						
	Acier galvanisé à chaud	60 x 109	60230000		053	20305	17,22/m
	↔ 3 m  18 m						
	Treillis angulaire						
	Acier inoxydable AISI 304	60 x 109	60250000		053	20302	32,08/m
↔ 3 m  18 m							
	Etrier pour treillis angulaire						
	Acier à zingage électrolytique, bichromaté		67020051	✓	053	20307	10,12/pc.
 10 pc.							
	Vis hexagonale à pointe conique						
	Acier à zingage électrolytique, bichromaté	M10x20	67020098	✓	176	20307	1,85/pc.
 10 pc.							

Systemes de suspension – treillis à câbles



SPLUS console Oméga Click

	type	référence	stock	page. catal.	groupe d'articles	prix en €
 5 pc.	Acier galvanisé Sendzimir	100	62021104	✓	126	20307 6,52/pc.
		150	62021154	✓	126	20307 8,42/pc.
		200	62021204	✓	126	20307 9,65/pc.
		300	62021304	✓	126	20307 11,38/pc.
		400	62021404	✓	126	20307 17,01/pc.

SPLUS console Oméga Click

 5 pc.	Acier galvanisé à chaud	100	62031104	✓	126	20307 9,98/pc.
		150	62031154		126	20307 12,76/pc.
		200	62031204	✓	126	20307 13,68/pc.
		300	62031304	✓	126	20307 14,63/pc.
		400	62031404		126	20307 22,57/pc.

SPLUS console Oméga Click

 5 pc.	Black C8	100	62081104	✓	126	20307 9,98/pc.
		150	62081154		126	20307 12,76/pc.
		200	62081204	✓	126	20307 13,68/pc.
		300	62081304	✓	126	20307 14,63/pc.
		400	62081404		126	20307 22,57/pc.

SPLUS console Oméga Click

 5 pc.	Acier inoxydable AISI 304	100	62051104		126	20307 20,62/pc.
		150	62051154		126	20307 25,58/pc.
		200	62051204		126	20307 32,18/pc.
		300	62051304		126	20307 39,00/pc.
		400	62051404		126	20307 47,44/pc.

SPLUS étrier en C Oméga Click

 4 pc.	Acier galvanisé Sendzimir	100	62022104	✓	126	20307 12,87/pc.
		150	62022154	✓	126	20307 13,52/pc.
		200	62022204	✓	126	20307 14,54/pc.
		300	62022304	✓	126	20307 17,01/pc.
		400	62022404	✓	126	20307 25,10/pc.

SPLUS étrier en C Oméga Click

 4 pc.	Acier galvanisé à chaud	100	62032104	✓	126	20307 17,01/pc.
		150	62032154		126	20307 18,71/pc.
		200	62032204	✓	126	20307 20,89/pc.
		300	62032304	✓	126	20307 25,03/pc.
		400	62032404		126	20307 38,27/pc.

SPLUS étrier en C Oméga Click



 4 pc.	Black C8	100	62082104	✓	126	20307 17,01/pc.
		150	62082154		126	20307 18,71/pc.
		200	62082204	✓	126	20307 20,89/pc.
		300	62082304	✓	126	20307 25,03/pc.
		400	62082404		126	20307 38,27/pc.

SPLUS étrier en C Oméga Click







 4 pc.	Acier inoxydable AISI 304	100	62052104		126	20307 35,19/pc.
		150	62052154		126	20307 38,17/pc.
		200	62052204		126	20307 50,18/pc.
		300	62052304		126	20307 57,65/pc.
		400	62052404		126	20307 66,63/pc.



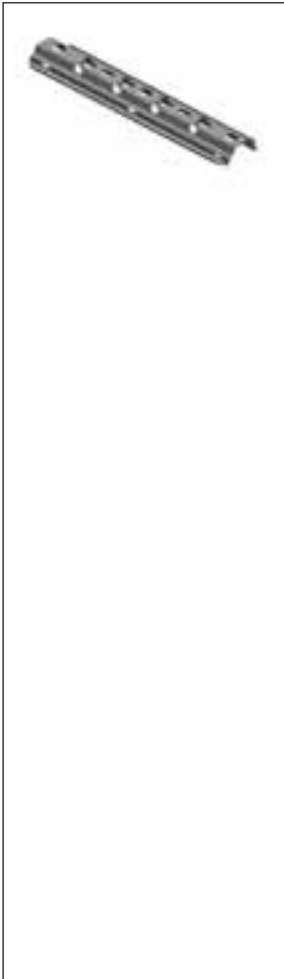











Systemes de suspension – treillis à câbles

	type	référence	stock	page. catal.	groupe d'articles	prix en €	
	RPLUS console Click						
	Acier galvanisé Sendzimir	100	62025103	✓	128	20307	8,14/pc.
	 4 pc.	150	62025153	✓	128	20307	9,50/pc.
		200	62025203	✓	128	20307	10,93/pc.
		300	62025303	✓	128	20307	12,51/pc.
		400	62025403		128	20307	18,07/pc.
		500	62025503		128	20307	20,97/pc.
600		62025603		128	20307	23,86/pc.	
	RPLUS console Click						
	Acier galvanisé à chaud	100	62035103	✓	128	20307	12,58/pc.
	 4 pc.	150	62035153	✓	128	20307	14,06/pc.
		200	62035203	✓	128	20307	16,61/pc.
		300	62035303	✓	128	20307	20,56/pc.
		400	62035403	✓	128	20307	23,00/pc.
		500	62035503		128	20307	28,68/pc.
600		62035603		128	20307	33,37/pc.	
	RPLUS console Click						
	Black C8	100	62085103	✓	128	20307	12,58/pc.
	 4 pc.	150	62085153		128	20307	14,06/pc.
		200	62085203	✓	128	20307	16,61/pc.
		300	62085303	✓	128	20307	20,56/pc.
		400	62085403		128	20307	23,00/pc.
		500	62085503		128	20307	28,68/pc.
600		62085603		128	20307	33,37/pc.	
	RPLUS console						
	Acier inoxydable AISI 304	100	62055103	✓	128	20307	28,30/pc.
	 4 pc.	150	62055153	✓	128	20307	31,20/pc.
		200	62055203	✓	128	20307	34,90/pc.
		300	62055303	✓	128	20307	42,37/pc.
	 4 pc.	400	62055403	✓	128	20307	70,99/pc.
		500	62055503	✓	128	20307	80,11/pc.
600		62055603	✓	128	20307	91,02/pc.	
		Kit embout étrier réglable					
	Acier galvanisé à chaud		62037002		130	20307	20,23/pc.
	Kit embout étrier réglable						
	Acier inoxydable AISI 304		62057002		130	20307	sur demande

Systemes de suspension – treillis à câbles

	type	référence	 stock	page. catal.	groupe d'articles	prix en €	
	SPLUS console Oméga Click						
	Acier galvanisé Sendzimir	100	63022104	✓	142	20307	4,41/pc.
	 10 pc.	150	63022154	✓	142	20307	4,87/pc.
		200	63022204	✓	142	20307	6,11/pc.
		300	63022304	✓	142	20307	7,19/pc.
		400	63022404	✓	142	20307	9,72/pc.
		500	63022504	✓	142	20307	10,95/pc.
		600	63022604	✓	142	20307	14,47/pc.
	SPLUS console Oméga Click						
	Acier galvanisé à chaud	100	63032104		142	20307	7,33/pc.
	 10 pc.	150	63032154		142	20307	7,84/pc.
		200	63032204		142	20307	9,59/pc.
		300	63032304		142	20307	11,51/pc.
		400	63032404		142	20307	13,98/pc.
		500	63032504		142	20307	16,50/pc.
		600	63032604		142	20307	19,75/pc.
	SPLUS console Oméga Click						
	Black C8	100	63082104	✓	142	20307	9,34/pc.
	 10 pc.	150	63082154		142	20307	9,48/pc.
		200	63082204	✓	142	20307	9,59/pc.
		300	63082304	✓	142	20307	11,51/pc.
400		63082404		142	20307	13,98/pc.	
500		63082504		142	20307	16,50/pc.	
600		63082604		142	20307	19,75/pc.	
SPLUS console Oméga Click							
Acier inoxydable AISI 304	100	63052104		142	20307	14,02/pc.	
 10 pc.	150	63052154		142	20307	16,93/pc.	
	200	63052204		142	20307	19,63/pc.	
	300	63052304		142	20307	24,52/pc.	
	400	63052404		142	20307	31,19/pc.	
	500	63052504		142	20307	38,09/pc.	
	600	63052604		142	20307	46,21/pc.	
SPLUS profilé Oméga Click							
Acier galvanisé Sendzimir							
↔ 1 m		67020110		142	20307	29,33/m	
↔ 2 m		67020111		142	20307	29,33/m	
↔ 3 m		67020112		142	20307	29,33/m	
SPLUS profilé Oméga Click							
Acier galvanisé à chaud							
↔ 1 m		67030110		142	20307	47,80/m	
↔ 2 m		67030111		142	20307	47,80/m	
↔ 3 m		67030112		142	20307	47,80/m	
SPLUS protecteur Oméga Click							
Matière synthétique rouge		62031084		138	20307	1,03/pc.	
 50 pc.							

Systemes de suspension – treillis à câbles

	type	référence	stock	page. catal.	groupe d'articles	prix en €
	SPLUS cheville Oméga					
	Matière synthétique rouge	62031085		138	20307	0,51/pc.
	 50 pc.					
	SPLUS pendard Oméga					
	Acier galvanisé Sendzimir	500	62021504	✓	144	20307 19,45/pc.
		600	62021604	✓	144	20307 23,20/pc.
	 5 pc.					
	SPLUS pendard Oméga					
	Acier galvanisé à chaud	500	62031504		144	20307 26,18/pc.
		600	62031604		144	20307 31,34/pc.
	 5 pc.					
	SPLUS pendard Oméga					
	Black C8	500	62081504		144	20307 26,18/pc.
	600	62081604		144	20307 31,34/pc.	
 5 pc.						
SPLUS pendard Oméga						
Acier inoxydable AISI 304	500	62051504		144	20307 54,81/pc.	
	600	62051604		144	20307 62,38/pc.	
 5 pc.						
	Etrier de plafond, ouvert					
	Acier galvanisé Sendzimir		67030060		148	20307 3,70/pc.
	 10 pc.					
	Etrier de plafond, réglable					
	Lamellar zinc		67030061		148	20307 8,82/pc.
	Agrafe pour poutre en I					
	Acier à zingage électrolytique		67020048		150	20307 38,07/pc.
	Support panneau sandwich					
	Acier galvanisé Sendzimir	45	67020020		150	20307 5,26/pc.
		90	67020120		150	20307 5,71/pc.
	 10 pc.					
	Support panneau sandwich					
	Acier galvanisé à chaud	45	67030020		150	20307 8,50/pc.
	90	67030120		150	20307 9,10/pc.	
 10 pc.						

Systemes de suspension – treillis à câbles

	type	référence	 stock	page. catal.	groupe d'articles	prix en €	
	Boulon à collet carré et écrou 6 pans à embase crénelée						
	Acier à zingage électrolytique	M6x12	67010093	✓	174	20309	0,36/pc.
	 100 pc.						
	Boulon à collet carré et écrou 6 pans à embase crénelée						
	Acier galvanisé à chaud	M6x12	67030093	✓	174	20309	0,50/pc.
	 100 pc.						
	Boulon à collet carré						
	Acier à zingage électrolytique	M6x12	67010099	✓	174	20309	0,27/pc.
	 100 pc.	M6x20	67010100	✓	174	20309	0,30/pc.
	Boulon à collet carré						
	Acier à zingage électrolytique, bichromaté	M6x20	67020100		174	20307	0,39/pc.
	 100 pc.						
	Boulon à collet carré						
	Acier galvanisé à chaud	M6x12	67030099		174	20309	0,34/pc.
	 100 pc.	M6x20	67030100	✓	174	20309	0,47/pc.
		M6x30	67030109	✓	174	20309	0,50/pc.
Boulon à collet carré							
Acier inoxydable AISI 316L	M6x20	67060100		174	20309	1,75/pc.	
 100 pc.							
	Ecrou 6 pans à embase crénelée						
	Acier à zingage électrolytique	M6	64010059	✓	174	20309	0,21/pc.
	 50 pc.						
	Ecrou 6 pans à embase crénelée						
	Acier à zingage électrolytique, bichromaté	M6	64020059		174	20307	0,21/pc.
	 50 pc.						
	Ecrou 6 pans à embase crénelée						
	Lamellar zinc	M6	64030059	✓	174	20309	0,26/pc.
 50 pc.							
Ecrou 6 pans à embase crénelée							
Acier inoxydable AISI 316L	M6	64060059	✓	174	20309	1,03/pc.	
 50 pc.							

Systemes de suspension – treillis à câbles



Boulon

	type	référence	stock	page. catal.	groupe d'articles	prix en €
Acier à zingage électrolytique 100 pc.	M6x15	67020054		175	20307	0,26/pc.
	M8x15	67010068		175	20307	0,44/pc.
	M8x20	67010065		175	20307	0,51/pc.
	M8x35	67010066		175	20307	0,68/pc.
	M8x65	67020092		175	20307	0,85/pc.
	M10x20	67020059		175	20307	0,85/pc.
	M10x35	67020077		175	20307	1,11/pc.
	M10x60	67020010		175	20307	1,73/pc.

Boulon

	type	référence	stock	page. catal.	groupe d'articles	prix en €
Acier galvanisé à chaud 100 pc.	M8x15	67030068		175	20307	0,67/pc.
	M8x20	67030065	✓	175	20307	0,63/pc.
	M8x35	67030066	✓	175	20307	0,88/pc.
	M10x20	67030059		175	20307	1,14/pc.
	M10x35	67030077	✓	175	20307	1,68/pc.
	M10x60	67030010		175	20307	2,58/pc.

Boulon

	type	référence	stock	page. catal.	groupe d'articles	prix en €
Acier inoxydable AISI 316L 100 pc.	M8x20	67060065		175	20307	1,09/pc.
	M8x35	67060066		175	20307	1,90/pc.
	M10x20	67060059		175	20307	2,40/pc.
	M10x35	67060077		175	20307	3,04/pc.
	M10x60	67060010		175	20307	4,55/pc.

Ecrou hexagonal

	type	référence	stock	page. catal.	groupe d'articles	prix en €
Acier à zingage électrolytique 100 pc.	M8	67020095		175	20307	0,18/pc.
	M10	67020079		175	20307	0,21/pc.

Ecrou hexagonal

	type	référence	stock	page. catal.	groupe d'articles	prix en €
Acier à zingage électrolytique, bichromaté 100 pc.	M8	67020062		175	20307	0,17/pc.
	M10	67020014		175	20307	0,30/pc.

Ecrou hexagonal

	type	référence	stock	page. catal.	groupe d'articles	prix en €
Acier galvanisé à chaud 100 pc.	M8	67030062		175	20307	0,24/pc.
	M10	67030014		175	20307	0,80/pc.

Ecrou hexagonal

	type	référence	stock	page. catal.	groupe d'articles	prix en €
Acier inoxydable AISI 304 100 pc.	M8	67060062		175	20307	1,12/pc.
	M10	67060014		175	20307	2,56/pc.

Rondelle

	type	référence	stock	page. catal.	groupe d'articles	prix en €
Acier à zingage électrolytique 100 pc.	M8	67020083		176	20307	0,08/pc.
	M10	67020061		176	20307	0,21/pc.

Rondelle

	type	référence	stock	page. catal.	groupe d'articles	prix en €
Acier à zingage électrolytique, bichromaté 100 pc.	M8	67020063		176	20307	0,11/pc.
	M10	67020013		176	20307	0,21/pc.





Rondelle

	type	référence	stock	page. catal.	groupe d'articles	prix en €
Acier galvanisé à chaud 100 pc.	M8	67030063		176	20307	0,11/pc.
	M10	67030013		176	20307	0,31/pc.

Rondelle

	type	référence	stock	page. catal.	groupe d'articles	prix en €
Acier inoxydable AISI 316L 100 pc.	M8	67060063		176	20307	0,57/pc.
	M10	67060064		176	20307	0,83/pc.

Systemes de suspension – treillis à câbles

	type	référence	 stock	page. catal.	groupe d'articles	prix en €
	Rondelle étoilée					
	Acier inoxydable	M8	67020084	176	20307	0,27/pc.
	 100 pc.					
	Rondelle étoilée					
	Acier inoxydable	M10	67020086	176	20307	0,36/pc.
	 100 pc.					
	Tige filetée					
	Acier à zingage électrolytique	M6	67020140	148	20307	4,91/pc.
	bichromaté	M8	67020044	148	20307	5,42/pc.
	↔ 0,5 m					
	Tige filetée					
	Acier inoxydable AISI 316L	M8	67060044	148	20307	29,37/pc.
	↔ 0,5 m					
	Tige filetée					
	Acier à zingage électrolytique, bichromaté	M6	67020141	148	20307	6,03/m
		M8	67020045	✓ 148	20307	6,22/m
		M10	67020145	148	20307	7,69/m
	↔ 1 m					
	Tige filetée					
	Acier inoxydable AISI 316L	M6	67060141	148	20307	35,32/m
		M8	67060045	148	20307	38,34/m
		M10	67060145	148	20307	48,11/m
↔ 1 m						

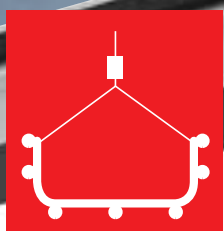

spiderband®

Système de suspension avec câble

Découvrez ici les atouts de **spiderband®**:

- ✓ un montage simple et rapide grâce au système flexible
- ✓ un éventail de possibilités de fixation
- ✓ un montage simple grâce au nombre limité d'articles
- ✓ une grande capacité de charge jusqu'à 120 kg.

rejiband®
CE **pemsa**







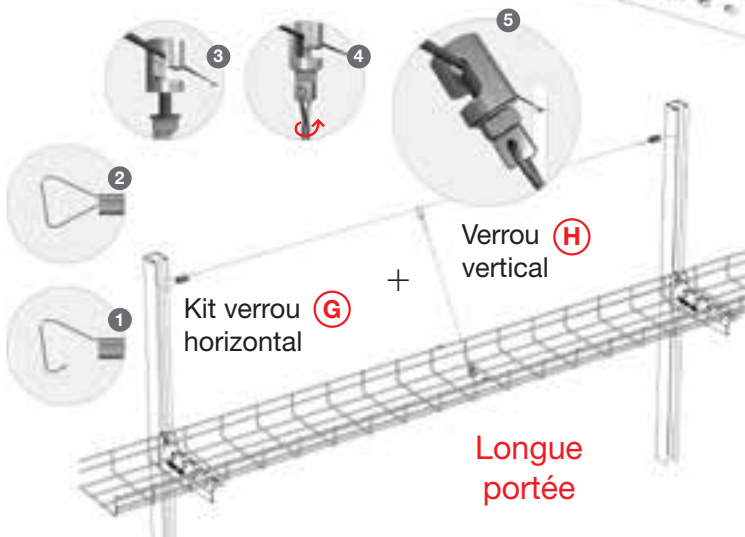
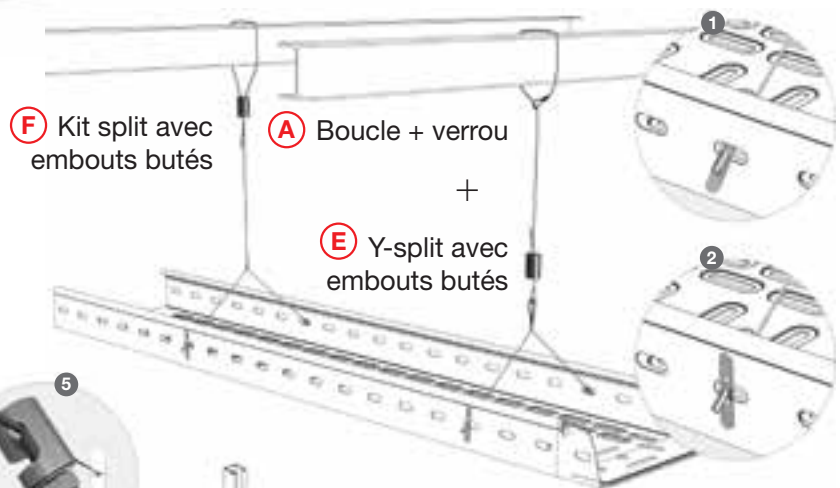
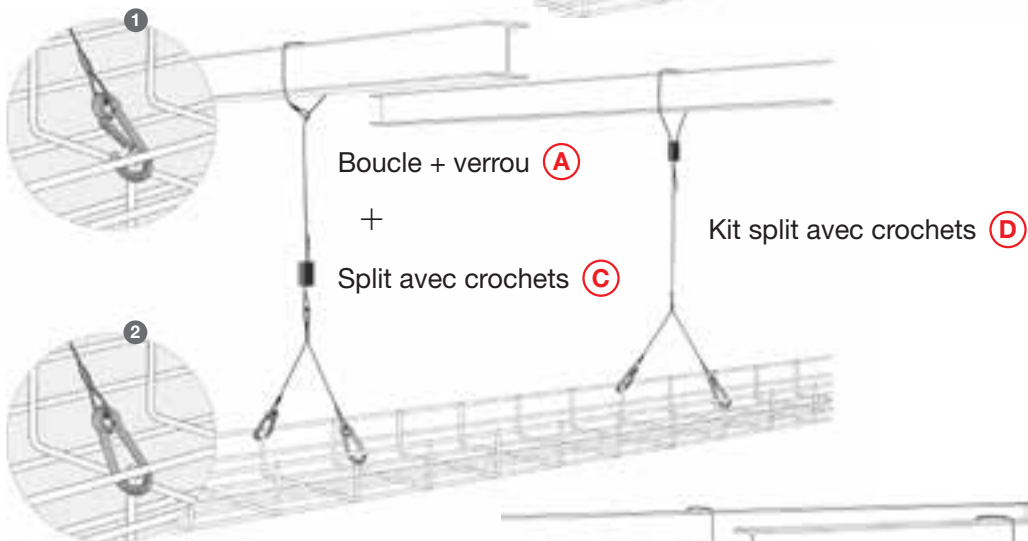
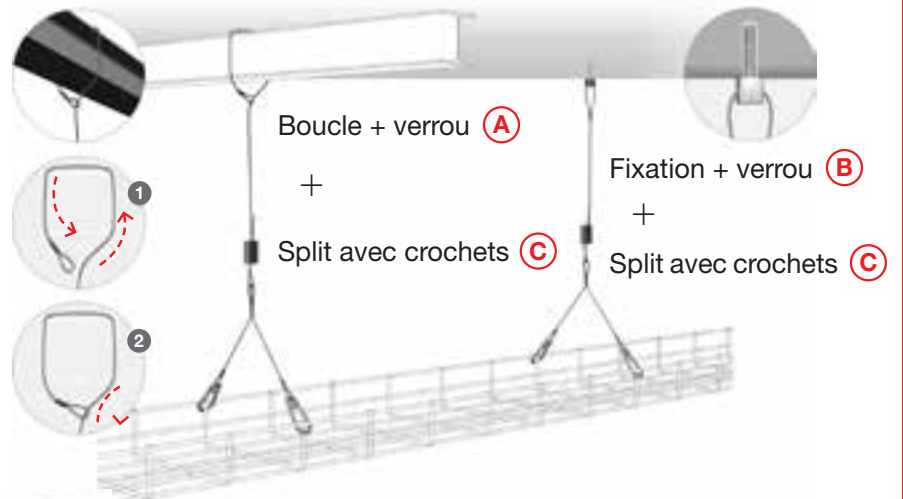

Vue d'ensemble de l'installation





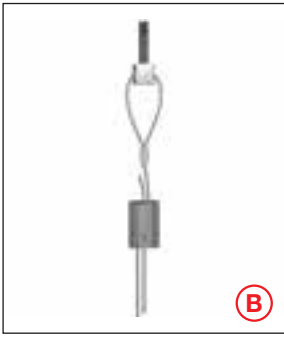







spiderband®



Systeme de suspension avec cable SPIDERBAND

	type	référence	stock	page. catal.	groupe d'articles	prix en €	
Verrou							
	Aluminium	10	62301100	✓	166	10505	4,52/pc.
	 10 pc.	50	62301400	✓	166	10505	5,10/pc.
		120	62301800		166	10505	9,31/pc.
Câble							
	Acier à zingage électrolytique						
	↔ 200 m	10	62302102	✓	166	10505	0,48/m
	↔ 100 m	50	62302401	✓	166	10505	0,55/m
120		62302801		166	10505	0,84/m	
Boucle + verrou							
 (A)	Acier à zingage électrolytique						
	 10 pc.	10/1	62303101	✓	166	10505	7,23/pc.
		45/1	62303301	✓	166	10505	8,79/pc.
		90/1	62303601		166	10505	20,44/pc.
		10/3	62303103		166	10505	9,20/pc.
		45/3	62303303		166	10505	11,08/pc.
		90/3	62303603		166	10505	23,04/pc.
		10/5	62303105		166	10505	11,18/pc.
45/5		62303305	✓	166	10505	13,26/pc.	
90/5	62303605		166	10505	25,58/pc.		
Fixation + verrou							
 (B)	Acier à zingage électrolytique						
	10/M6x20/1	62304101	✓	166	10505	8,27/pc.	
	45/M8x20/1	62304301	✓	166	10505	10,40/pc.	
	90/M8x20/1	62304601		166	10505	14,61/pc.	
	10/M6x20/3	62304103		166	10505	9,36/pc.	
	45/M8x20/3	62304303		166	10505	11,65/pc.	
	90/M8x20/3	62304603		166	10505	16,33/pc.	
	10/M6x20/5	62304105		166	10505	15,50/pc.	
	45/M8x20/5	62304305		166	10505	13,57/pc.	
90/M8x20/5	62304605		166	10505	22,05/pc.		
Split avec crochets							
 (C)	Acier à zingage électrolytique	50/300	62305430	✓	168	10505	6,92/pc.
	 10 pc.	50/460	62305440		168	10505	7,18/pc.
Split avec crochets + verrou							
 (D)	Acier à zingage électrolytique	35/300/1	62307231	✓	168	10505	15,03/pc.
	 10 pc.	90/300/1	62307631	✓	168	10505	23,09/pc.
		35/300/3	62307233		168	10505	16,33/pc.
		90/300/3	62307633		168	10505	24,54/pc.
		35/460/1	62307241	✓	168	10505	15,08/pc.
		90/460/1	62307641		168	10505	23,45/pc.
		35/460/3	62307243		168	10505	16,38/pc.
		90/460/3	62307643		168	10505	24,96/pc.

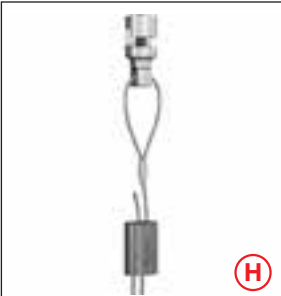
Systeme de suspension avec cable SPIDERBAND

	type	référence	 stock	page. catal.	groupe d'articles	prix en €	
	Y-split avec embouts butés						
	Acier à zingage électrolytique	35/300	62306230	✓	168	10505	6,29/pc.
	 10 pc.	35/460	62306240		168	10505	6,55/pc.
		35/500	62306250		168	10505	6,71/pc.
Y-split avec embouts butés + verrou							
	Acier à zingage électrolytique	35/300/1	62308231	✓	168	10505	13,68/pc.
	 10 pc.	90/300/1	62308631	✓	168	10505	19,40/pc.
		35/300/3	62308233		168	10505	14,77/pc.
		90/300/3	62308633		168	10505	21,32/pc.
		35/460/1	62308241	✓	168	10505	13,57/pc.
		90/460/1	62308641		168	10505	19,60/pc.
		35/460/3	62308243		168	10505	14,82/pc.
		90/460/3	62308643		168	10505	21,48/pc.
	Verrou + câble horizontal + verrou						
	Acier à zingage électrolytique						
	 5 pc.	75/5	62309501		170	10505	72,23/pc.
		75/10	62309502		170	10505	83,67/pc.
 2 pc.	75/15	62309503		170	10505	95,11/pc.	
	Crochet + câble vertical						
	Acier à zingage électrolytique	35/1	62310201		170	10505	14,77/pc.
	 10 pc.						



Les profilés Stagobel

La gamme de profilés Stagobel est disponible dans **diverses longueurs, largeurs et finitions** : un profilé simple ou double, avec ou sans rebord dentelé, différents types de perforation, etc., et ce, en Sendzimir, en galvanisé à chaud ou en acier inoxydable.



Les profilés Stagobel peuvent notamment être utilisés dans :

- ✓ les constructions légères en acier
- ✓ la construction de machines
- ✓ les équipements techniques d'un bâtiment
- ✓ la suspension de systèmes de support de câbles (échelles à câbles, goulottes, chemins de câbles, etc.)
- ✓ les systèmes de ventilation et de gaines d'air, le HVAC
- ✓ les systèmes sanitaires.







	1	2	3	4	5	6	7	8
Dimensions (mm)	30x15	30x15	41x21	41x41	41x41	41x41	41x21 (double)	41x41 (double)
Epaisseur (mm)	2,0	1,5	2,0 2,5	2,0 2,5	2,5	2,5	2,0	2,5
Longueur (mm)	2000	4000	6000 3000 6000	6000 3000 6000	6000	6000	6000	6000
Modèle de perforation	✓	✓	✓	✓	✓		✓	✓
Rebord dentelé			✓	✓			✓	✓
G.S.	✓	✓						
H.D.			✓	✓			✓	✓
INOX 316			✓	✓	✓	✓		

G.S. galvanisation Sendzimir NBN EN 10346 – recommandé dans les environnements corrosifs C2 (faible)
H.D. galvanisation à chaud NBN EN ISO 1461 – recommandé dans les environnements corrosifs C3/C4 (moyen/haut)
INOX 316 acier inoxydable AISI 316 – recommandé dans les environnements corrosifs C5-M (très élevé/maritime)



 voir page 4

Profilés









Profilés

	type	référence	 stock	page. catal.	groupe d'articles	prix en €	
	Profilé 30-15-2.0 avec perforations 30x11 + 5x5						
	Acier galvanisé Sendzimir						
↔ 2 m	2000	PROF30-15-2.0-2/GS	✓	-	10501	6,76/m	
	Profilé 30-15-1.5 avec perforations 30x14						
	Acier galvanisé Sendzimir						
↔ 4 m	4000	PROF30-15-1.5-4/GS	✓	-	10501	5,39/m	
	Profilé 41-21-2.0 avec perforations 30x14						
	Acier galvanisé à chaud						
↔ 6 m	6000	PROF41-21-2.0-6/HD	✓	-	10501	14,76/m	
	Profilé 41-21-2.5 avec perforations 30x14						
	Acier galvanisé à chaud						
	↔ 3 m	3000	PROF41-21-2.5-3/HD	✓	-	10501	18,52/m
	↔ 6 m	6000	PROF41-21-2.5-6/HD	✓	-	10501	18,52/m
	Profilé 41-41-2.0 avec perforations 30x14						
	Acier galvanisé à chaud						
↔ 6 m	6000	PROF41-41-2.0-6/HD	✓	-	10501	22,11/m	
	Profilé 41-41-2.5 avec perforations 30x14						
	Acier galvanisé à chaud						
	↔ 3 m	3000	PROF41-41-2.5-3/HD	✓	-	10501	25,13/m
↔ 6 m	6000	PROF41-41-2.5-6/HD	✓	-	10501	25,13/m	

Profilés

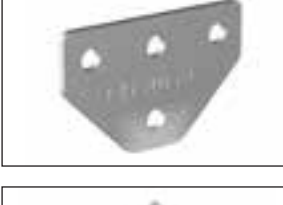
	type	référence	 stock	page. catal.	groupe d'articles	prix en €
	Profilé double 41-21-2.0, hauteur = 42 mm, avec perforations 30x14					
	Acier galvanisé à chaud					
↔ 6 m	6000	PROFD41-21-2.0-6/HD	✓	-	10501	33,00/m
	Profilé double 41-41-2.5, hauteur = 82 mm, avec perforations 30x14					
	Acier galvanisé à chaud					
↔ 6 m	6000	PROFD41-41-2.5-6/HD	✓	-	10501	56,27/m
	Bouchon pour profilé épaisseur 2,5 mm et hauteur 21 mm					
	Matière synthétique, vert foncé					
 50 pc.	21	KOKSPLDB	✓	-	10503	1,94/pc.
	Bouchon pour profilé épaisseur 2,5 mm et hauteur 41 mm					
	Matière synthétique, vert foncé					
 50 pc.	41	KOKSPSDB	✓	-	10503	3,02/pc.
	Plaque plate 40x6x184					
	Lamellar zinc					
	N1	67030205	✓	156	10503	5,60/pc.
	Jonction externe 41x41					
	Acier galvanisé à chaud					
	N2	67030214	✓	156	10503	18,24/pc.
	Equerre 90° 50x50x40					
	Lamellar zinc					
	N3	67030201	✓	157	10503	2,56/pc.
	Equerre 90° 95x95x40					
	Lamellar zinc					
	N4	67030202	✓	157	10503	5,12/pc.

Profilés

	type	référence	 stock	page. catal.	groupe d'articles	prix en €
	Equerre 135° 75x105x39					
	Acier galvanisé à chaud	N5 67030210	✓	157	10503	4,39/pc.
	Equerre 45° 66x63x39					
	Acier galvanisé à chaud	N6 67030209	✓	157	10503	4,39/pc.
	Equerre plate 88x6x88					
	Acier galvanisé à chaud	N7 67030211	✓	158	10503	5,92/pc.
	Plaque raccord T 90° 105x51x90					
	Lamellar zinc	N8 67030204	✓	158	10503	11,20/pc.
	Plaque raccord T plate 90x6x140					
	Lamellar zinc	N9 67030203	✓	158	10503	14,63/pc.
	Raccord trois directions 114x6x114					
	Acier galvanisé à chaud	N10 67030212	✓	158	10503	7,11/pc.
	Equerre 90° renforcée 101x101x48					
	Acier galvanisé à chaud	N11 67030213	✓	159	10503	15,76/pc.
	Etrier Oméga (40x47x142)					
	Lamellar zinc	N12 67030207	✓	159	10503	15,76/pc.

Profilés

	type	référence	 stock	page. catal.	groupe d'articles	prix en €
	Etrier Oméga (40x87x141)					
Acier galvanisé à chaud	N13	67030208	✓	159	10503	6,80/pc.
	Etrier Oméga (40x27x142)					
Lamellar zinc	N14	67030206	✓	159	10503	7,52/pc.
	Equerre 90° double 50x90x90					
Acier galvanisé à chaud	N15	67030215	✓	160	10503	6,17/pc.
	Equerre 90° triple 50x90x90					
Acier galvanisé à chaud	N16	67030216	✓	160	10503	13,04/pc.
	Support profilé 41x41 (106x150x150)					
Lamellar zinc		67030064	✓	160	10503	33,43/pc.
	Support profilé 41x82 (94x150x150)					
Acier galvanisé à chaud		67030164	✓	160	10503	30,87/pc.
	Articulation réglable 154x135x77					
Acier galvanisé à chaud		67030102	✓	161	10503	28,63/pc.
	Etrier pour profilé / poutre en I (95x70x80)					
Lamellar zinc		67030101	✓	161	10503	15,12/pc.
	Accouplement treillis / profilé					
Lamellar zinc		67030049	✓	156	20307	2,64/pc.
 50 pc.						











Profilés











	type	référence	 stock	page. catal.	groupe d'articles	prix en €
	Profilé 41-21-2.5 avec perforations 25x11 Acier inoxydable 316L ↔ 6 m	6000 PROF41-21-2.5-6/RVS316P	-	10501	105,60/m	
	Profilé 41-21-2.5 sans perforations Acier inoxydable 316L ↔ 6 m	6000 PROF41-21-2.5-6/RVS316	-	10501	101,04/m	
	Profilé 41-41-2.5 avec perforations 25x12,80 Acier inoxydable AISI 316L ↔ 6 m	6000 PROF41-41-2.5-6/RVS316P ✓	-	10501	111,16/m	
	Profilé 41-41-2.5 sans perforations Acier inoxydable AISI 316L ↔ 6 m	6000 PROF41-41-2.5-6/RVS316 ✓	-	10501	106,37/m	
	Plaque plate 4 trous Acier inoxydable AISI 316L	ES1067SS	-	10503	30,99/pc.	
	Jonction externe 41x41 4 trous Acier inoxydable AISI 316L	ES1377SS	-	10503	155,19/pc.	
	Equerre 90° 2 trous Acier inoxydable AISI 316L	ES1026SS	-	10503	15,04/pc.	

Profilés

	type	référence	 stock	page. catal.	groupe d'articles	prix en €
	Equerre 90° 4 trous					
	Acier inoxydable AISI 316L	ES1325SS	-	10503		29,67/pc.
	Etrier d'angle 135° 2 trous					
	Acier inoxydable AISI 316L	ES1546SS	-	10503		21,87/pc.
	Etrier d'angle 45° 2 trous					
	Acier inoxydable AISI 316L	ES1186SS	-	10503		21,29/pc.
	Equerre plate 3 trous					
	Acier inoxydable AISI 316L	ES1036SS	-	10503		18,74/pc.
	Plaque raccord T 90° 4 trous					
	Acier inoxydable AISI 316L	ES1359SS	-	10503		56,06/pc.
	Plaque raccord T plate 4 trous					
	Acier inoxydable AISI 316L	ES1358SS	-	10503		56,06/pc.
	Equerre 90° renforcée					
	Acier inoxydable AISI 316L	ES2484SS	-	10503		69,62/pc.
	Etrier oméga 41x41 5 trous					
	Acier inoxydable AISI 316L	ES1047SS	-	10503		34,85/pc.
	Etrier oméga 41x82 3 trous					
	Acier inoxydable AISI 316L	ES1737SS	-	10503		62,72/pc.
	Etrier oméga 41x21 3 trous					
	Acier inoxydable AISI 316L	ES4047SS	-	10503		28,93/pc.

Profilés

	type	référence	 stock	page. catal.	groupe d'articles	prix en €	
	Equerre 90° double 4 trous						
	Acier inoxydable AISI 316L	ES2223SS	-	10503	39,78/pc.		
	Support profilé 41x41						
	Acier inoxydable AISI 316L	ES2072ASQSS	-	10503	214,87/pc.		
	Support profilé 41x82						
	Acier inoxydable AISI 316L	ES2073SS	-	10503	91,49/pc.		
	Etrier profilé / poutre en I						
	Acier inoxydable AISI 316L	ES2785SS	-	10503	38,39/pc.		
	Accouplement treillis / profilé						
	Acier inoxydable AISI 316L	67060050	044	20307	3,81/pc.		
	Ecrou coulissant						
	Acier à zingage électrolytique	M6	67020055	✓	154	10503	1,03/pc.
	 100 pc.	M8	67010056	✓	154	10503	1,03/pc.
		M10	67011058	✓	-	10503	1,48/pc.
		Ecrou coulissant					
	Acier galvanisé à chaud	M6	67030054	✓	154	10503	1,38/pc.
	 100 pc.	M8	67030056	✓	154	10503	1,38/pc.
		M10	67031058	✓	-	10503	1,72/pc.
		Ecrou coulissant					
	Acier inoxydable AISI 316L	M6	67060054	✓	154	10503	8,35/pc.
 100 pc.	M8	67060056	✓	154	10503	8,67/pc.	
	M10	67060058	✓	154	10503	9,89/pc.	

	type	référence	stock	page. catal.	groupe d'articles	prix en €	
	Ecrou coulissant avec ressort						
	 100 pc.	Acier à zingage électrolytique M6 / 21	67620058	-	-	10503	1,58/pc.
		M6 / 41	67620158	-	-	10503	1,64/pc.
		M8 / 21	67820058	-	-	10503	1,73/pc.
		M8 / 41	67820158	-	-	10503	1,73/pc.
		M10 / 21	67020058	✓	154	10503	1,83/pc.
		M10 / 41	67020158	✓	154	10503	2,06/pc.
	Ecrou coulissant avec ressort						
	 100 pc.	Acier galvanisé à chaud M6 / 21	67630058	✓	-	10503	1,60/pc.
		M6 / 41	67630158	✓	-	10503	1,72/pc.
		M8 / 21	67830058	✓	-	10503	1,83/pc.
		M8 / 41	67830158	✓	-	10503	1,89/pc.
		M10 / 21	67030058	✓	154	10503	2,00/pc.
		M10 / 41	67030158	✓	154	10503	2,11/pc.
	Ecrou coulissant avec ressort						
 100 pc.	Acier inoxydable AISI 316L M6 / 21	67660058	-	-	10503	10,11/pc.	
	M6 / 41	67660158	-	-	10503	10,11/pc.	
	M8 / 21	67860058	-	-	10503	10,44/pc.	
	M8 / 41	67860158	-	-	10503	10,44/pc.	
	M10 / 21	67160058	-	-	10503	12,91/pc.	
	M10 / 41	67860158	-	-	10503	10,44/pc.	
	Boulon coulissant à ressort						
	Acier à zingage électrolytique M10x30	67020159	154	-	10503	3,15/pc.	
	 100 pc.						
	Boulon hexagonal						
	 100 pc.	Acier à zingage électrolytique M8X35	67010066	175	-	20307	0,68/pc.
		M10X35	67020077	175	-	20307	1,11/pc.
	Boulon hexagonal						
	 100 pc.	Acier galvanisé à chaud M8X35	67030066	✓	175	20307	0,88/pc.
		M10X35	67030077	✓	175	20307	1,68/pc.
	Boulon hexagonal						
	 100 pc.	Acier inoxydable AISI 316L M8X35	67060066	175	-	20307	1,90/pc.
		M10X35	67060077	175	-	20307	3,04/pc.



Conduits, raccords et presse-étoupes











Vous désirez une protection supplémentaire contre un impact mécanique des câbles dans une installation électrique industrielle ou vous souhaitez un look industriel dans votre bureau ou votre maison? Alors, les conduits métalliques rigides de PEMSA vous offrent la solution idéale.







Cette gamme complète de conduits métalliques, assortie de nombreux accessoires et presse-étoupes, vous garantit une installation facile. Disponible sous forme de plug-in ou avec raccord à vis ainsi qu'en plusieurs tailles et versions (zingage électrolytique, galvanisé à chaud, aluminium ou acier inoxydable).

 **pemsa**



Conduits métalliques











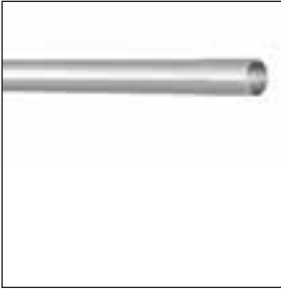

RL / RLGC	RR / RRG	RAL	RINOX
 	 	 	 

Caractéristiques				
E.Z.	✓	✓		
H.D.	✓	✓		
Aluminium			✓	
INOX 304				✓
DN/SW min.	DN16	DN16	DN16	DN20
DN/SW max.	DN63	DN63	DN63	DN40
	-45°C	-45°C	-45°C	-45°C
	+400°C	+400°C	+250°C	+250°C
	Très haut			
	Rigide			
	OK	OK	OK	OK
	OK	OK	OK	OK
	IP54	IP54	IP54	IP54
	5557	5557	4456	4456
Applications				
 Tertiaire	✓	✓	✓	✓
 Tunnels	✓	✓	✓	✓
 Centres de données	✓	✓	✓	✓
 Installations PV				
 Industrie alimentaire				✓
 Pétrochimie	✓	✓	✓	✓
 G.S.	page 136, 138	page 136, 138	-	-
 H.D.	page 136, 138	page 136, 138	-	-
 Aluminium	-	-	page 140	page 141
 INOX 304	-	-	page 140	page 141

E.Z. zingage électrolytique NBN EN ISO 2081 – recommandé dans les environnements corrosifs C1 (très faible)
H.D. galvanisation à chaud NBN EN ISO 1461 – recommandé dans les environnements corrosifs C3/C4 (moyen/haut)
Aluminium aluminium
INOX 304 acier inoxydable AISI 304 – recommandé dans les environnements corrosifs C5-I (très haut – industrie)

 voir page 4

Conduits, raccords et presse-étoupes

	type	référence	stock	page. catal.	groupe d'articles	prix en €
Conduit sans filetage						
Acier à zingage électrolytique						
	←→ 3 m	51 m DN16	13040016	✓	180 20322	3,47/m
		51 m DN20	13040020	✓	180 20322	4,12/m
		30 m DN25	13040025	✓	180 20322	5,11/m
		21 m DN32	13040032	✓	180 20322	7,93/m
		15 m DN40	13040040	✓	180 20322	10,30/m
		15 m DN50	13040050	✓	180 20322	13,27/m
		9 m DN63	13040063	✓	180 20322	17,08/m
	Conduit avec filetage					
Acier à zingage électrolytique						
	←→ 3 m	51 m DN16	13030016		180 20322	4,65/m
		51 m DN20	13030020		180 20322	5,19/m
		30 m DN25	13030025		180 20322	6,25/m
		21 m DN32	13030032		180 20322	8,34/m
		15 m DN40	13030040		180 20322	11,44/m
		15 m DN50	13030050		180 20322	14,18/m
		9 m DN63	13030063		180 20322	23,48/m
	Accouplement sans filetage					
Acier à zingage électrolytique						
		100 pc. DN16	55006016	✓	181 20322	1,92/pc.
		50 pc. DN20	55006020	✓	181 20322	2,00/pc.
		25 pc. DN25	55006025	✓	181 20322	2,46/pc.
		20 pc. DN32	55006032	✓	181 20322	3,09/pc.
		12 pc. DN40	55006040	✓	181 20322	4,60/pc.
		6 pc. DN50	55006050	✓	181 20322	6,42/pc.
		3 pc. DN63	55006063	✓	181 20322	11,29/pc.
	Accouplement avec filetage					
Acier à zingage électrolytique						
		50 pc. DN16	55004016		181 20322	1,85/pc.
		50 pc. DN20	55004020		181 20322	1,96/pc.
		50 pc. DN25	55004025		181 20322	2,19/pc.
		25 pc. DN32	55004032		181 20322	3,06/pc.
		20 pc. DN40	55004040		181 20322	3,81/pc.
		10 pc. DN50	55004050		181 20322	6,20/pc.
		6 pc. DN63	55004063		181 20322	10,46/pc.
	Courbe 90° sans filetage					
Acier à zingage électrolytique						
		10 pc. DN16	55015016	✓	181 20322	4,39/pc.
		10 pc. DN20	55015020	✓	181 20322	5,00/pc.
		10 pc. DN25	55015025	✓	181 20322	5,22/pc.
		10 pc. DN32	55015032	✓	181 20322	7,74/pc.
		5 pc. DN40	55015040	✓	181 20322	12,34/pc.
		5 pc. DN50	55015050	✓	181 20322	21,91/pc.
		3 pc. DN63	55015063	✓	181 20322	30,68/pc.
	Courbe 90° avec filetage					
Acier à zingage électrolytique						
		10 pc. DN16	55014016		181 20322	7,26/pc.
		10 pc. DN20	55014020		181 20322	7,52/pc.
		10 pc. DN25	55014025		181 20322	8,02/pc.
		10 pc. DN32	55014032		181 20322	11,65/pc.
		5 pc. DN40	55014040		181 20322	17,45/pc.
		5 pc. DN50	55014050		181 20322	32,84/pc.
		3 pc. DN63	55014063		181 20322	51,18/pc.







Conduits, raccords et presse-étoupes

	type	référence	stock	page. catal.	groupe d'articles	prix en €		
	Press-étoupe (conduit) RL							
	Acier à zingage électrolytique							
		50 pc.	DN16	55007016	✓	182	20322	2,37/pc.
		50 pc.	DN20	55007020	✓	182	20322	2,63/pc.
		25 pc.	DN25	55007025	✓	182	20322	2,77/pc.
		25 pc.	DN32	55007032	✓	182	20322	3,67/pc.
		15 pc.	DN40	55007040	✓	182	20322	4,21/pc.
		15 pc.	DN50	55007050	✓	182	20322	5,36/pc.
6 pc.		DN63	55007063	✓	182	20322	8,46/pc.	
Ecrou TMC								
Laiton nickelé								
		100 pc.	M16	40011160	-	20322	0,40/pc.	
		100 pc.	M20	40011200	-	20322	0,54/pc.	
		105 pc.	M25	40011250	-	20322	0,83/pc.	
		50 pc.	M32	40011320	-	20322	1,12/pc.	
		25 pc.	M40	40011400	-	20322	1,87/pc.	
		25 pc.	M50	40011500	-	20322	3,45/pc.	
		25 pc.	M63	40011630	-	20322	5,75/pc.	
		Press-étoupe (conduit) RMT						
Laiton nickelé								
		100 pc.	DN16	37031160	182	20322	3,16/pc.	
		100 pc.	DN20	37031201	182	20322	3,88/pc.	
		50 pc.	DN25	37031250	182	20322	5,15/pc.	
		25 pc.	DN32	37031320	182	20322	9,46/pc.	
		20 pc.	DN40	37031400	182	20322	13,99/pc.	
		10 pc.	DN50	37031500	182	20322	25,57/pc.	
		5 pc.	DN63	37031630	182	20322	48,09/pc.	
		Manchon filetage						
Acier à zingage électrolytique								
		50 pc.	M16	55005016	182	20322	1,92/pc.	
		50 pc.	M20	55005020	182	20322	2,23/pc.	
		50 pc.	M25	55005025	182	20322	2,75/pc.	
		25 pc.	M32	55005032	182	20322	3,63/pc.	
		20 pc.	M40	55005040	182	20322	5,32/pc.	
		10 pc.	M50	55005050	182	20322	6,38/pc.	
		6 pc.	M63	55005063	182	20322	11,48/pc.	
		Clip de maintien						
Acier zingué / élastomère								
		100 pc.	DN7	39095000	✓	182	20322	1,92/pc.
		100 pc.	DN10	39095100	✓	182	20322	2,27/pc.
		100 pc.	DN12	39095200	✓	182	20322	2,34/pc.
		100 pc.	DN17	39095400	✓	182	20322	2,68/pc.
		50 pc.	DN23	39095500	✓	182	20322	2,84/pc.
		30 pc.	DN29	39095600	✓	182	20322	3,25/pc.
		20 pc.	DN36	39095700	✓	182	20322	3,85/pc.
		20 pc.	DN48	39095800	✓	182	20322	4,87/pc.
		Embout de protection						
		Chlorure de polyvinyle						
		100 pc.	DN16	55111016	183	20322	1,29/pc.	
		100 pc.	DN20	55111020	183	20322	1,37/pc.	
		100 pc.	DN25	55111025	183	20322	1,55/pc.	
		50 pc.	DN32	55111032	183	20322	2,20/pc.	
		50 pc.	DN40	55111040	183	20322	2,52/pc.	
		25 pc.	DN50	55111050	183	20322	3,02/pc.	
		20 pc.	DN63	55111063	183	20322	3,52/pc.	

Conduits, raccords et presse-étoupes

	type	référence	stock	page. catal.	groupe d'articles	prix en €		
Pièce en T sans filetage								
Aluminium								
	10 pc.	DN16	55081016	183	20322	9,46/pc.		
	10 pc.	DN20	55081020	183	20322	10,86/pc.		
	8 pc.	DN25	55081025	183	20322	11,87/pc.		
	2 pc.	DN32	55081032	183	20322	14,96/pc.		
	2 pc.	DN40	55081040	183	20322	21,79/pc.		
	1 pc.	DN50	55081050	183	20322	32,01/pc.		
Pièce en T avec filetage								
Aluminium								
	10 pc.	DN16	55080016	183	20322	9,57/pc.		
	10 pc.	DN20	55080020	183	20322	10,50/pc.		
	8 pc.	DN25	55080025	183	20322	11,98/pc.		
	2 pc.	DN32	55080032	183	20322	15,10/pc.		
	2 pc.	DN40	55080040	183	20322	21,62/pc.		
	1 pc.	DN50	55080050	183	20322	31,69/pc.		
Courbe sans filetage								
Aluminium								
	20 pc.	DN16	55071016	183	20322	8,10/pc.		
	20 pc.	DN20	55071020	183	20322	9,13/pc.		
	12 pc.	DN25	55071025	183	20322	9,75/pc.		
	4 pc.	DN32	55071032	183	20322	12,41/pc.		
	4 pc.	DN40	55071040	183	20322	17,95/pc.		
	2 pc.	DN50	55071050	183	20322	25,17/pc.		
Courbe avec filetage								
Aluminium								
	20 pc.	DN16	55070016	183	20322	8,53/pc.		
	20 pc.	DN20	55070020	183	20322	9,21/pc.		
	12 pc.	DN25	55070025	183	20322	9,82/pc.		
	4 pc.	DN32	55070032	183	20322	13,06/pc.		
	4 pc.	DN40	55070040	183	20322	18,45/pc.		
	2 pc.	DN50	55070050	183	20322	25,43/pc.		
Conduit sans filetage								
Acier galvanisé à chaud								
	↔ 3 m	30 m	DN16	13040116	✓	184	20322	5,18/m
		30 m	DN20	13040120	✓	184	20322	5,94/m
		30 m	DN25	13040125	✓	184	20322	7,70/m
		21 m	DN32	13040132	✓	184	20322	10,04/m
		15 m	DN40	13040140	✓	184	20322	12,01/m
		15 m	DN50	13040150	✓	184	20322	16,76/m
		15 m	DN63	13040163	✓	184	20322	26,04/m
	Conduit avec filetage							
Acier galvanisé à chaud								
	↔ 3 m	30 m	DN16	13030116		184	20322	6,84/m
		30 m	DN20	13030120		184	20322	9,63/m
		30 m	DN25	13030125		184	20322	12,31/m
		21 m	DN32	13030132		184	20322	15,98/m
		15 m	DN40	13030140		184	20322	20,05/m
		15 m	DN50	13030150		184	20322	25,27/m
		15 m	DN63	13030163		184	20322	34,17/m



Conduits, raccords et presse-étoupes

	type	référence	stock	page. catal.	groupe d'articles	prix en €	
Accouplement sans filetage							
Acier galvanisé à chaud							
	25 pc.	DN16	55006116	✓	184	20322	2,00/pc.
	50 pc.	DN20	55006120	✓	184	20322	2,27/pc.
	50 pc.	DN25	55006125	✓	184	20322	2,91/pc.
	50 pc.	DN32	55006132	✓	184	20322	4,01/pc.
	25 pc.	DN40	55006140	✓	184	20322	6,34/pc.
	10 pc.	DN50	55006150	✓	184	20322	8,50/pc.
	5 pc.	DN63	55006163	✓	184	20322	12,80/pc.
Accouplement avec filetage							
Acier galvanisé à chaud							
	25 pc.	DN16	55004116		184	20322	2,41/pc.
	50 pc.	DN20	55004120		184	20322	2,75/pc.
	50 pc.	DN25	55004125		184	20322	3,81/pc.
	50 pc.	DN32	55004132		184	20322	5,06/pc.
	25 pc.	DN40	55004140		184	20322	6,87/pc.
	10 pc.	DN50	55004150		184	20322	10,53/pc.
	5 pc.	DN63	55004163		184	20322	14,39/pc.
Courbe 90° sans filetage							
Acier galvanisé à chaud							
	15 pc.	DN16	55015116	✓	185	20322	9,46/pc.
	25 pc.	DN20	55015120	✓	185	20322	9,61/pc.
	25 pc.	DN25	55015125	✓	185	20322	10,54/pc.
	20 pc.	DN32	55015132	✓	185	20322	15,03/pc.
	15 pc.	DN40	55015140	✓	185	20322	24,14/pc.
	5 pc.	DN50	55015150	✓	185	20322	34,71/pc.
	3 pc.	DN63	55015163	✓	185	20322	49,77/pc.
Courbe 90° avec filetage							
Acier galvanisé à chaud							
	15 pc.	DN16	55014116		185	20322	11,19/pc.
	25 pc.	DN20	55014120		185	20322	12,63/pc.
	25 pc.	DN25	55014125		185	20322	14,07/pc.
	20 pc.	DN32	55014132		185	20322	18,67/pc.
	15 pc.	DN40	55014140		185	20322	27,04/pc.
	5 pc.	DN50	55014150		185	20322	47,25/pc.
	3 pc.	DN63	55014163		185	20322	64,85/pc.
Collier de fixation							
Acier galvanisé à chaud							
	100 pc.	DN16	55032116	✓	185	20322	2,19/pc.
	100 pc.	DN20	55032120	✓	185	20322	2,23/pc.
	100 pc.	DN25	55032125	✓	185	20322	2,38/pc.
	100 pc.	DN32	55032132	✓	185	20322	2,75/pc.
	50 pc.	DN40	55032140	✓	185	20322	3,70/pc.
	50 pc.	DN50	55032150	✓	185	20322	5,06/pc.
	25 pc.	DN63	55032163	✓	185	20322	8,50/pc.
Collier de fixation oméga							
Acier galvanisé à chaud							
	50 pc.	DN16	55033116		185	20322	2,38/pc.
	50 pc.	DN20	55033120		185	20322	2,46/pc.
	50 pc.	DN25	55033125		185	20322	2,64/pc.
	25 pc.	DN32	55033132		185	20322	3,02/pc.
	25 pc.	DN40	55033140		185	20322	4,08/pc.
	25 pc.	DN50	55033150		185	20322	5,59/pc.
	20 pc.	DN63	55033163		185	20322	9,36/pc.

Conduits, raccords et presse-étoupes

	type	référence	 stock	page. catal.	groupe d'articles	prix en €
Conduit sans filetage						
Aluminium						
	↔ 3 m	30 m DN16	13020016	186	20322	4,82/m
		30 m DN20	13020020	186	20322	6,11/m
		30 m DN25	13020025	186	20322	7,95/m
		30 m DN32	13020032	186	20322	10,97/m
		15 m DN40	13020040	186	20322	14,82/m
		15 m DN50	13020050	186	20322	18,34/m
		15 m DN63	13020063	186	20322	28,77/m
Accouplement sans filetage						
Aluminium						
		50 pc. DN16	55002016	186	20322	2,88/pc.
		50 pc. DN20	55002020	186	20322	3,38/pc.
		50 pc. DN25	55002025	186	20322	4,03/pc.
		50 pc. DN32	55002032	186	20322	4,96/pc.
		20 pc. DN40	55002040	186	20322	6,11/pc.
		20 pc. DN50	55002050	186	20322	9,64/pc.
		20 pc. DN63	55002063	186	20322	11,76/pc.
Courbe 90° sans filetage						
Aluminium						
		15 pc. DN16	55012016	186	20322	13,35/pc.
		25 pc. DN20	55012020	186	20322	14,60/pc.
		25 pc. DN25	55012025	186	20322	15,82/pc.
		20 pc. DN32	55012032	186	20322	19,03/pc.
		15 pc. DN40	55012040	186	20322	21,79/pc.
		5 pc. DN50	55012050	186	20322	26,11/pc.
		3 pc. DN63	55012063	186	20322	33,80/pc.
Clip conduit						
Aluminium						
		50 pc. DN16	55022016	187	20322	1,78/pc.
		50 pc. DN20	55022020	187	20322	1,92/pc.
		50 pc. DN25	55022025	187	20322	2,03/pc.
		50 pc. DN32	55022032	187	20322	2,30/pc.
		25 pc. DN40	55022040	187	20322	2,72/pc.
Collier de fixation oméga						
Aluminium						
		50 pc. DN16	55031016	187	20322	2,68/pc.
		50 pc. DN20	55031020	187	20322	2,79/pc.
		50 pc. DN25	55031025	187	20322	2,91/pc.
		25 pc. DN32	55031032	187	20322	2,98/pc.
		25 pc. DN40	55031040	187	20322	3,40/pc.

Conduits, raccords et presse-étoupes

	type	référence	 stock	page. catal.	groupe d'articles	prix en €	
	Conduit sans filetage						
	Acier inoxydable AISI 304						
	←→ 3 m	15 m	DN16	13021016	188	20322	18,27/m
		15 m	DN20	13021020	188	20322	19,49/m
		15 m	DN25	13021025	188	20322	24,06/m
		15 m	DN32	13021032	188	20322	29,85/m
		9 m	DN40	13021040	188	20322	38,31/m
	9 m	DN50	13021050	188	20322	55,71/m	
	Accouplement sans filetage						
	Acier inoxydable AISI 304						
		25 pc.	DN16	55003016	188	20322	13,45/pc.
		50 pc.	DN20	55003020	188	20322	16,33/pc.
		50 pc.	DN25	55003025	188	20322	17,88/pc.
		50 pc.	DN32	55003032	188	20322	19,42/pc.
		25 pc.	DN40	55003040	188	20322	27,19/pc.
	10 pc.	DN50	55003050	188	20322	58,26/pc.	
	Courbe 90° sans filetage						
	Acier inoxydable AISI 304						
		15 pc.	DN16	55013016	188	20322	40,42/pc.
		25 pc.	DN20	55013020	188	20322	42,91/pc.
		25 pc.	DN25	55013025	188	20322	46,61/pc.
		20 pc.	DN32	55013032	188	20322	62,14/pc.
		10 pc.	DN40	55013040	188	20322	80,81/pc.
	5 pc.	DN50	55013050	188	20322	123,68/pc.	
	Collier de fixation						
	Acier inoxydable AISI 304						
		50 pc.	DN16	55034016	188	20322	5,47/pc.
		50 pc.	DN20	55034020	188	20322	6,23/pc.
		50 pc.	DN25	55034025	188	20322	7,41/pc.
		25 pc.	DN32	55034032	188	20322	10,50/pc.
		25 pc.	DN40	55034040	188	20322	12,84/pc.
	25 pc.	DN50	55034050	188	20322	14,79/pc.	
	Collier de fixation oméga						
	Acier inoxydable AISI 304						
		50 pc.	DN16	55035016	188	20322	7,77/pc.
		50 pc.	DN20	55035020	188	20322	10,11/pc.
		50 pc.	DN25	55035025	188	20322	13,23/pc.
		25 pc.	DN32	55035032	188	20322	17,88/pc.
		25 pc.	DN40	55035040	188	20322	21,00/pc.
	25 pc.	DN50	55035050	188	20322	27,19/pc.	





Systemes de support de câbles avec maintien de fonction

Objectif

Les systemes de support de câbles avec maintien de fonction sont essentiels pour une infrastructure à l'épreuve du feu. Les systemes de sécurité tels qu'un éclairage de secours, un systeme d'alarme incendie, ... doivent, en cas d'incendie, continuer à fonctionner parfaitement pendant une durée déterminée. Il est dès lors crucial qu'outre le câblage, les systemes de support de câbles (échelle à câbles, chemin de câbles et treillis à câbles) aient aussi ces propriétés ignifuges et garantissent donc, en cas d'incendie, la fonctionnalité et la fiabilité de l'installation durant cette période.

Application

Les systemes de support de câbles avec maintien de fonction sont notamment appliqués pour des installations d'évacuation des fumées, de ventilation, d'alarme et de sécurité dans les bâtiments publics, les immeubles de bureaux, les tunnels, les hôpitaux, ...



Echelles à câbles KHZPS – p. 144-145



Treillis à câbles Rejistaband – p. 146-148
Chemins de câbles Pemsaband – p. 149-151



Boîte de connexion E90 – p. 154-155



Attache OMEGA E90 – p. 153





Etrier de câbles E90 – p. 152



Attache câbles E90 – p. 152





Maintien de fonction – échelles à câbles

	type	référence	 stock	page. catal.	groupe d'articles	prix en €
	Echelle à câbles KHZPS					
	Acier galvanisé Sendzimir	150	725350	✓	23	10308 41,87/m
	↔ 6 m	200	725351	✓	23	10308 41,87/m
		300	725352	✓	23	10308 43,30/m
		400	725353	✓	23	10308 45,11/m
	Accouplement 21					
	Zinc+	21	795051	✓	78	10313 14,41/pc.
	 10 pc.					
	Console 50					
	Acier galvanisé à chaud	50/ 150	723433	✓	32	10304 14,57/pc.
		50/ 200	723434	✓	32	10304 14,94/pc.
		50/ 300	723436	✓	32	10304 17,20/pc.
		50/ 400	723437	✓	32	10304 27,19/pc.
	Etrier 42					
	Acier galvanisé Sendzimir	42	795239		34	10313 5,49/pc.
	 10 pc.					
	Pendard simple 2F					
	Acier galvanisé à chaud	2F/ 280	717196	✓	46	10313 22,79/pc.
		2F/ 370	717197	✓	46	10313 26,04/pc.
		2F/ 505	717198	✓	46	10313 29,56/pc.
		2F/ 640	794202		-	10313 30,61/pc.
		2F/ 730	717199	✓	46	10313 33,93/pc.
	Fixation tige/console 82					
	Acier galvanisé à chaud	82	786768		36	10313 68,77/pc.
	 10 pc.					

Maintien de fonction – échelles à câbles

	type	référence	 stock	page. catal.	groupe d'articles	prix en €
	Tige filetée M10					
	Acier à zingage électrolytique	2000	716792		42	10313
	↔ 2 m					
	Erou hexagonal					
	Acier galvanisé à chaud	M10	723938		42	10313
	 100 pc.					
	Boulon hexagonal M8 x 50					
	Acier à zingage électrolytique	M8x50	795132		-	10313
	 100 pc.					
	Erou hexagonal					
	Acier à zingage électrolytique	M8	794715		-	10313
	 100 pc.					

Maintien de fonction – treillis à câbles

	type	référence	 stock	page. catal.	groupe d'articles	prix en €	
	Treillis à câbles Rejiband 60						
	Acier à zingage électrolytique, bichromaté						
	↔ 3 m	 24 m	60 x 100	60222100	4	20301 sur demande	
			60 x 150	60222150	4	20301 sur demande	
		 18 m	60 x 200	60222200	4	20301 sur demande	
		 12 m	60 x 300	60222300	4	20301 sur demande	
		 6 m	60 x 400	60222400	4	20301 sur demande	
	Treillis à câbles Rejiband 60						
	Acier galvanisé à chaud						
	↔ 3 m	 24 m	60 x 100	60232100	✓	4	20305 17,92/m
			60 x 150	60232150	✓	4	20305 22,18/m
		 18 m	60 x 200	60232200	✓	4	20305 26,26/m
		 12 m	60 x 300	60232300	✓	4	20305 35,92/m
		 6 m	60 x 400	60232400	✓	4	20305 47,44/m
		Accouplement renforcé 61					
Acier à zingage électrolytique, bichromaté 64020061							
 50 pc.							
	Accouplement renforcé 61						
	Lamellar zinc 64030061						
	 50 pc.						
	Accouplement 60						
	Acier à zingage électrolytique, bichromaté 64020060						
	 50 pc.						
	Accouplement 60						
	Lamellar zinc 64030060						
	 50 pc.						











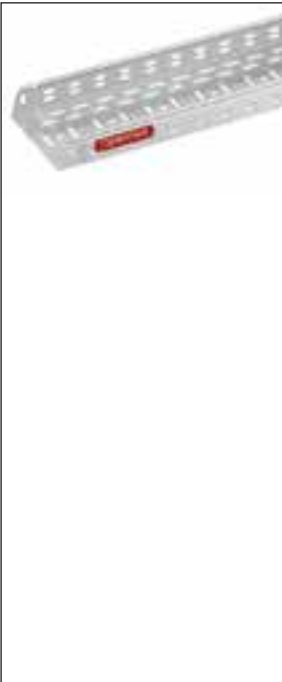



Maintien de fonction – treillis à câbles

	type	référence	stock	page. catal.	groupe d'articles	prix en €
	SPLUS console Oméga Click					
	Acier galvanisé Sendzimir	100	62021104	✓	4	20307 6,52/pc.
	 5 pc.	150	62021154	✓	4	20307 8,42/pc.
		200	62021204	✓	4	20307 9,65/pc.
		300	62021304	✓	4	20307 11,38/pc.
		400	62021404	✓	4	20307 17,01/pc.
SPLUS console Oméga Click						
Acier galvanisé à chaud	100	62031104	✓	4	20307 9,98/pc.	
 5 pc.	150	62031154		4	20307 12,76/pc.	
	200	62031204	✓	4	20307 13,68/pc.	
	300	62031304	✓	4	20307 14,63/pc.	
	400	62031404	✓	4	20307 22,57/pc.	
	SPLUS étrier en C Oméga Click					
Acier galvanisé Sendzimir	100	62022104	✓	8	20307 12,87/pc.	
 4 pc.	150	62022154	✓	8	20307 13,52/pc.	
	200	62022204	✓	8	20307 14,54/pc.	
	300	62022304	✓	8	20307 17,01/pc.	
	400	62022404	✓	8	20307 25,10/pc.	
	SPLUS étrier en C Oméga Click					
Acier galvanisé à chaud	100	62032104	✓	8	20307 17,01/pc.	
 4 pc.	150	62032154		8	20307 18,71/pc.	
	200	62032204	✓	8	20307 20,89/pc.	
	300	62032304	✓	8	20307 25,03/pc.	
	400	62032404		8	20307 38,27/pc.	
	SPLUS connecteur Oméga E90					
Lamellar zinc		62031090	✓	4	20307 6,44/pc.	
 60 pc.						
E90 accouplement 60						
Lamellar zinc	M6x30	64030160	✓	4	20307 2,18/pc.	
 50 pc.						
Tige filetée						
	Acier à zingage électrolytique, bichromaté	M8/0,5m	67020044		4	20307 5,42/pc.
		M8/1m	67020045	✓	4	20307 6,22/m
	↔ 0,5 m ↔ 1 m	M10/1m	67020145		4	20307 7,69/m
Ecrou hexagonal						
	Acier à zingage électrolytique, bichromaté	M8	67020062		4	20307 0,17/pc.
		M10	67020014		4	20307 0,30/pc.
 100 pc.						















Maintien de fonction – treillis à câbles

	type	référence	 stock	page. catal.	groupe d'articles	prix en €	
	Pendant simple						
	Acier galvanisé à chaud	500	82002610	10	20307	30,77/pc.	
		600	82002611	-	20307	33,77/pc.	
		800	82002612	-	20307	39,94/pc.	
		1000	82002613	10	20307	45,69/pc.	
	Pendant double						
	Acier galvanisé à chaud	500	82002622	10	20307	54,80/pc.	
		600	82002623	-	20307	60,87/pc.	
		800	82002624	-	20307	72,99/pc.	
		1000	82002625	10	20307	84,69/pc.	
	Boulon hexagonal						
	Acier à zingage électrolytique	M10x35	67020077	10	20307	1,11/pc.	
	Acier galvanisé à chaud	M10x35	67030077	✓	10	20307	1,68/pc.
	 100 pc.						
	Ecrou coulissant avec ressort						
	Acier à zingage électrolytique	M10/41	67020158	✓	10	10503	2,06/pc.
	Acier galvanisé à chaud	M10/41	67030158	✓	10	10503	2,11/pc.
	 100 pc.						
	RPLUS console Click						
	Acier galvanisé Sendzimir	100	62025103	✓	6	20307	8,14/pc.
		150	62025153	✓	6	20307	9,50/pc.
		200	62025203	✓	6	20307	10,93/pc.
		300	62025303	✓	6	20307	12,51/pc.
		400	62025403	✓	6	20307	18,07/pc.
	 4 pc.						
	RPLUS console Click						
	Acier galvanisé à chaud	100	62035103	✓	6	20307	12,58/pc.
		150	62035153	✓	6	20307	14,06/pc.
		200	62035203	✓	6	20307	16,61/pc.
		300	62035303	✓	6	20307	20,56/pc.
		400	62035403	✓	6	20307	23,00/pc.
	 4 pc.						
	RPLUS connecteur E90						
	Lamellar zinc		62035001	6	20307	6,44/pc.	
	 15 pc.						







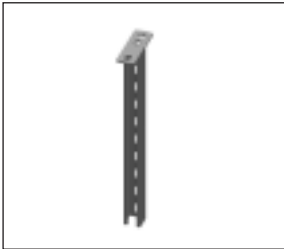

Maintien de fonction – chemins de câbles

	type	référence	 stock	page. catal.	groupe d'articles	prix en €	
	Chemin de câbles Pemsaband SX Click, H = 60 mm						
	Acier galvanisé Sendzimir						
	↔ 3 m	 24 m	60x100 75522100	✓	12	20308	10,44/m
		 12 m	60x150 75522150	✓	12	20308	13,94/m
			60x200 75522200	✓	12	20308	15,11/m
		 6 m	60x300 75522300	✓	12	20308	20,12/m
			60x400 75522400	✓	12	20308	29,07/m
	Chemin de câbles Pemsaband SX Click, H = 60 mm						
	Acier galvanisé à chaud						
	↔ 3 m	 24 m	60x100 75232100	✓	12	20308	27,26/m
	 12 m	60x150 75232150		12	20308	32,18/m	
		60x200 75232200	✓	12	20308	38,69/m	
	 6 m	60x300 75232300	✓	12	20308	49,25/m	
		60x400 75232400	✓	12	20308	63,61/m	
	Boulon à collet carré et écrou 6 pans à embase crénelée						
	Acier à zingage électrolytique	M6x12	67010093	✓	-	20309	0,36/pc.
	 100 pc.						
	Boulon à collet carré et écrou 6 pans à embase crénelée						
	Acier galvanisé à chaud	M6x12	67030093	✓	-	20309	0,50/pc.
	 100 pc.						
	Tige filetée						
	Acier à zingage électrolytique, bichromaté	M8/0,5m	67020044		12	20307	5,42/pc.
		M8/1m	67020045	✓	12	20307	6,22/m
	↔ 0,5 m ↔ 1 m	M10/1m	67020145		12	20307	7,69/m
	Écrou hexagonal						
	Acier à zingage électrolytique, bichromaté	M8	67020062		12	20307	0,17/pc.
		M10	67020014		12	20307	0,30/pc.
	 100 pc.						















Maintien de fonction – chemins de câbles

	type	référence	 stock	page. catal.	groupe d'articles	prix en €
	SPLUS console Oméga Click					
	Acier galvanisé Sendzimir	100	62021104	✓	12	20307 6,52/pc.
	 5 pc.	150	62021154	✓	12	20307 8,42/pc.
		200	62021204	✓	12	20307 9,65/pc.
		300	62021304	✓	12	20307 11,38/pc.
400		62021404	✓	12	20307 17,01/pc.	
	SPLUS console Oméga Click					
	Acier galvanisé à chaud	100	62031104	✓	12	20307 9,98/pc.
	 5 pc.	150	62031154		12	20307 12,76/pc.
		200	62031204	✓	12	20307 13,68/pc.
		300	62031304	✓	12	20307 14,63/pc.
400		62031404		12	20307 22,57/pc.	
	SPLUS connecteur Oméga E90					
	Lamellar zinc		62031090	✓	12	20307 6,44/pc.
 60 pc.						
	Boulon à collet carré					
	Acier galvanisé à chaud	M6x30	67030109	✓	12	20309 0,50/pc.
 100 pc.						
	Ecrou 6 pans à embase crénelée					
	Lamellar zinc	M6	64030059	✓	12	20309 0,26/pc.
 50 pc.						
	SPLUS profilé support Click					
	Acier galvanisé Sendzimir	100	63022104	✓	16	20307 4,41/pc.
	 10 pc.	150	63022154	✓	16	20307 4,87/pc.
		200	63022204	✓	16	20307 6,11/pc.
		300	63022304	✓	16	20307 7,19/pc.
400		63022404	✓	16	20307 9,72/pc.	
	SPLUS profilé support Click					
	Acier galvanisé à chaud	100	63032104		16	20307 7,33/pc.
	 10 pc.	150	63032154		16	20307 7,84/pc.
		200	63032204		16	20307 9,59/pc.
		300	63032304		16	20307 11,51/pc.
400		63032404		16	20307 13,98/pc.	









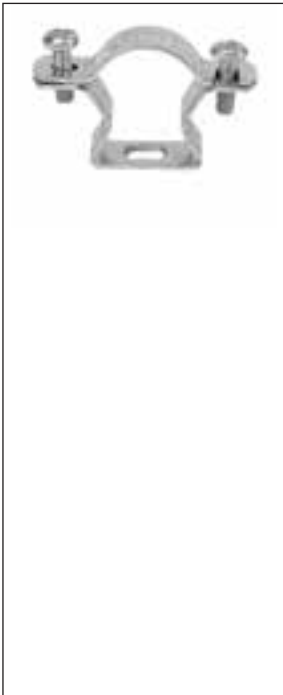

Maintien de fonction – chemins de câbles

	type	référence	 stock	page. catal.	groupe d'articles	prix en €	
	Pendant simple						
	Acier galvanisé à chaud	500	82002610	18	20307	30,77/pc.	
		600	82002611	-	20307	33,77/pc.	
		800	82002612	-	20307	39,94/pc.	
		1000	82002613	18	20307	45,69/pc.	
	Pendant double						
	Acier galvanisé à chaud	500	82002622	18	20307	54,80/pc.	
		600	82002623	-	20307	60,87/pc.	
		800	82002624	-	20307	72,99/pc.	
		1000	82002625	18	20307	84,69/pc.	
	RPLUS console Click						
	Acier galvanisé Sendzimir	100	62025103	✓	18	20307	8,14/pc.
	 4 pc.	150	62025153	✓	18	20307	9,50/pc.
		200	62025203	✓	18	20307	10,93/pc.
		300	62025303	✓	18	20307	12,51/pc.
	400	62025403	✓	18	20307	18,07/pc.	
	RPLUS console Click						
	Acier galvanisé à chaud	100	62035103	✓	18	20307	12,58/pc.
	 4 pc.	150	62035153	✓	18	20307	14,06/pc.
		200	62035203	✓	18	20307	16,61/pc.
		300	62035303	✓	18	20307	20,56/pc.
	400	62035403	✓	18	20307	23,00/pc.	
	RPLUS connecteur E90						
	Lamellar zinc		62035001		18	20307	6,44/pc.
	 15 pc.						

Maintien de fonction

	type	référence	 stock	page. catal.	groupe d'articles	prix en €	
	Attache pour câble simple						
	Acier galvanisé Sendzimir	diam. câble					
	 1000 pc. = 1 bt.	simple	4 mm	K6706PO	-	20508	259,14/bt.
		simple	6 mm	K6708PO	✓	20508	292,92/bt.
		simple	8 mm	K6710PO	✓	20508	296,91/bt.
simple		10 mm	K6712PO	✓	20508	299,06/bt.	
	Attache pour câble simple						
	Acier galvanisé à chaud	diam. câble					
	 1000 pc. = 1 bt.	simple	6 mm	K6708POGMT	-	20508	406,89/bt.
		simple	8 mm	K6710POGMT	-	20508	481,69/bt.
simple		10 mm	K6712POGMT	-	20508	555,26/bt.	
	Attache pour câble simple						
	Acier galvanisé Sendzimir	diam. câble					
 500 pc. = 1 bt.	simple	14 mm	K6716EP0	-	20508	222,14/bt.	
	Attache pour câble simple						
	Acier galvanisé à chaud	diam. câble					
	 500 pc. = 1 bt.	simple	14 mm	K6716EPOGMT	-	20508	333,75/bt.
	Attache pour câble simple						
	Acier galvanisé Sendzimir	diam. câble					
 400 pc. = 1 bt.	double	14 mm	K6716EDPO	-	20508	325,51/bt.	
	Attache pour câble simple						
	Acier galvanisé à chaud	diam. câble					
	 400 pc. = 1 bt.	double	14 mm	K6716EDPOGMT	-	20508	355,10/bt.
	Etrier pour groupe de câbles						
	Acier galvanisé Sendzimir		KSD2S	✓	20508	2,09/pc.	
 5 pc.							





Maintien de fonction

	type	référence	stock	page. catal.	groupe d'articles	prix en €	
	Attache Oméga pour plusieurs câbles						
	Acier galvanisé Sendzimir	diam. câble					
	 100 pc. = 1 bt.	12-14 mm	K5216EZNMS	-	20508	418,70/bt.	
		14-18 mm	K5220ZNMS	-	20508	358,95/bt.	
		18-22 mm	K5225ZNMS	-	20508	383,52/bt.	
	 50 pc. = 1 bt.	22-30 mm	K5232ZNMS	-	20508	244,60/bt.	
	 25 pc. = 1 bt.	38-50 mm	K5250ZNMS	-	20508	168,48/bt.	
		51-60 mm	K5263ZNMS	-	20508	192,90/bt.	
		Attache Oméga pour plusieurs câbles					
		Acier galvanisé à chaud	diam. câble				
 50 pc. = 1 bt.		12-14 mm	K5216EZNF	-	20508	194,34/bt.	
		14-18 mm	K5220ZNF	-	20508	206,53/bt.	
		18-22 mm	K5225ZNF	-	20508	220,09/bt.	
 25 pc. = 1 bt.		22-30 mm	K5232ZNF	-	20508	128,54/bt.	
 20 pc. = 1 bt.		30-38 mm	K5240ZNF	-	20508	125,77/bt.	
		38-50 mm	K5250ZNF	-	20508	149,44/bt.	
		51-60 mm	K5263ZNF	-	20508	176,81/bt.	
		Vis à béton 6,3X35					
	Acier galvanisé à chaud	6,3x35	KSB6.3X35POGMT	✓	20508	68,71/sac	
	 100 pc. = 1 sac						

Maintien de fonction

	type	référence	 stock	page. catal.	groupe d'articles	prix en €
	E90 Boîte de connexion IP66 pour câbles d'alimentation, avec bornier simple					
Matière synthétique exempte d'halogènes	1,5-6 mm ²	KKSK100P0	✓	-	20508	72,76/pc.
	E90 Boîte de connexion IP66 pour câbles d'alimentation, avec bornier simple					
Matière synthétique exempte d'halogènes	1,5-10 mm ²	KKSK125P010	-	-	20508	91,61/pc.
	E90 Boîte de connexion IP66 pour câbles d'alimentation, avec bornier simple					
Matière synthétique exempte d'halogènes	1,5-16 mm ²	KKSK175P016	-	-	20508	126,30/pc.
	E90 Boîte de connexion IP66 pour câbles d'alimentation, avec bornier double					
Matière synthétique exempte d'halogènes	1,5-6 mm ²	KKSK1252P06	✓	-	20508	98,52/pc.
	E90 Boîte de connexion IP66 pour câbles d'alimentation, avec bornier double					
Matière synthétique exempte d'halogènes	1,5-10 mm ²	KKSK1752P010	✓	-	20508	126,30/pc.

Maintien de fonction

	type	référence	 stock	page. catal.	groupe d'articles	prix en €
	E90 Boîte de connexion IP66 pour câbles d'alimentation, avec bornier simple et fusible					
Matière synthétique exempte d'halogènes	1,5-6 mm ²	KKSK125P06P	-	20508	106,16/pc.	
	E90 Boîte de connexion IP66 pour câbles d'alimentation, avec bornier simple et fusible					
Matière synthétique exempte d'halogènes	1,5-10 mm ²	KKSK175P010P	-	20508	138,20/pc.	
	E90 Boîte de connexion IP66 pour câbles de données, avec bornier					
Matière synthétique exempte d'halogènes	0,5-4 mm ²	KKSK125DPO	-	20508	107,68/pc.	
	E90 Boîte de connexion IP66 pour câbles de données, avec bornier					
Matière synthétique exempte d'halogènes	0,5-4 mm ²	KKSK175DPO	-	20508	141,47/pc.	



Canal de sol ouvert pour charges lourdes



Gaine de sol noyée –
boîte de sol en polyamide



Gaine de sol noyée –
boîte de sol en acier inoxydable



Gaine de sol noyée –
boîte de sol en acier inoxydable



Boîte de sol BODO
en aluminium



Boîte de sol BODO en matière synthétique



Boîte de sol en acier inoxydable



Systemes de gaines de sol

Systemes de canal de sol au ras du sol



Canal de sol ouvert pour bureaux page 160-161



Canal de sol ouvert pour charges lourdes page 162-163

Systemes de gaines de sol noyees



Gainne de sol noyee fermee Voir tableau de selection aux pages suivantes



Canal de sol noyee avec couvercle page 167-168

SYSTÈMES DE GAINES DE SOL NOYÉES POUR SOLS EN TAPIS (LINOLÉUM) - BOÎTES DE SOL EN POLYAMIDE

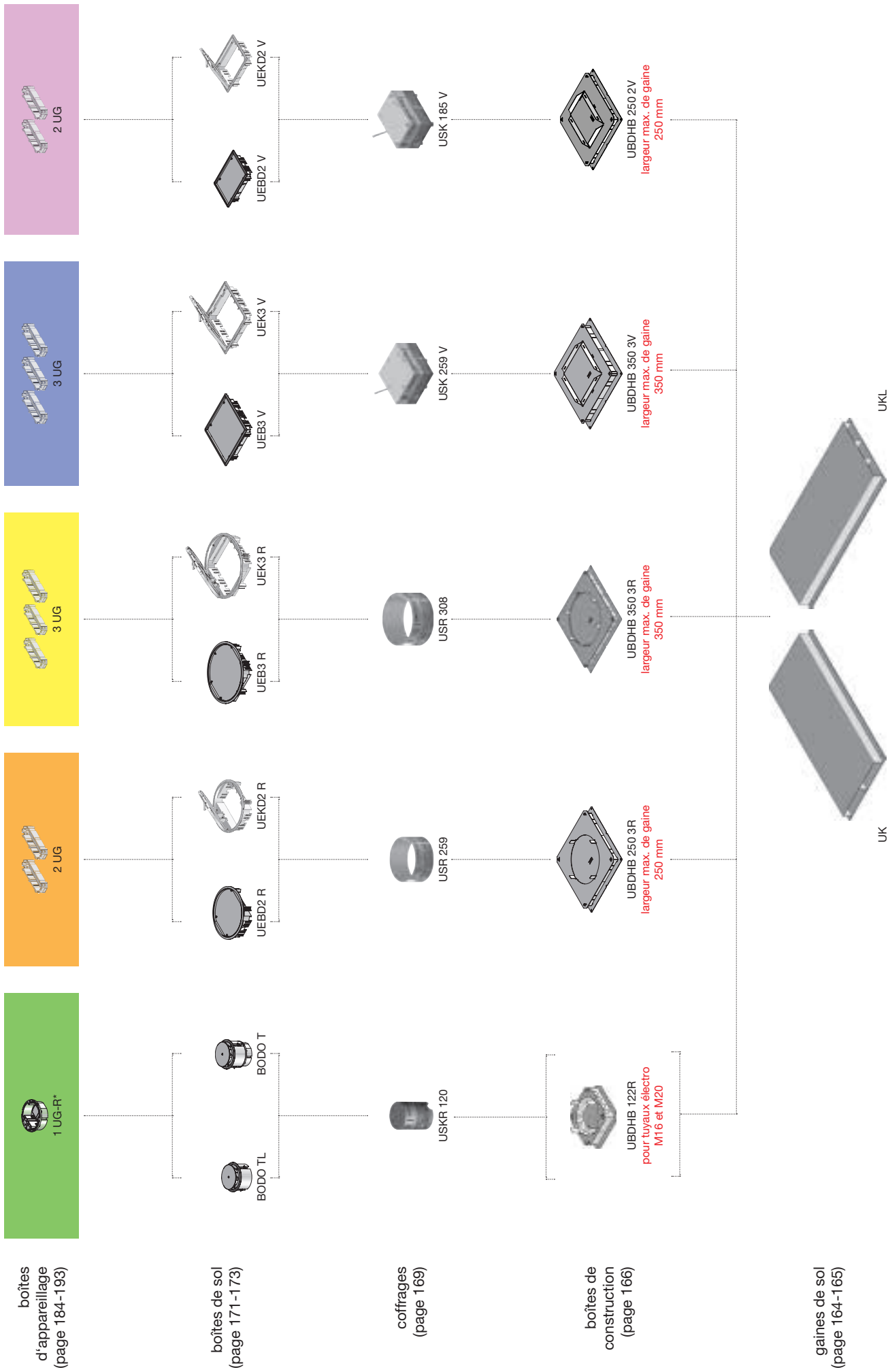

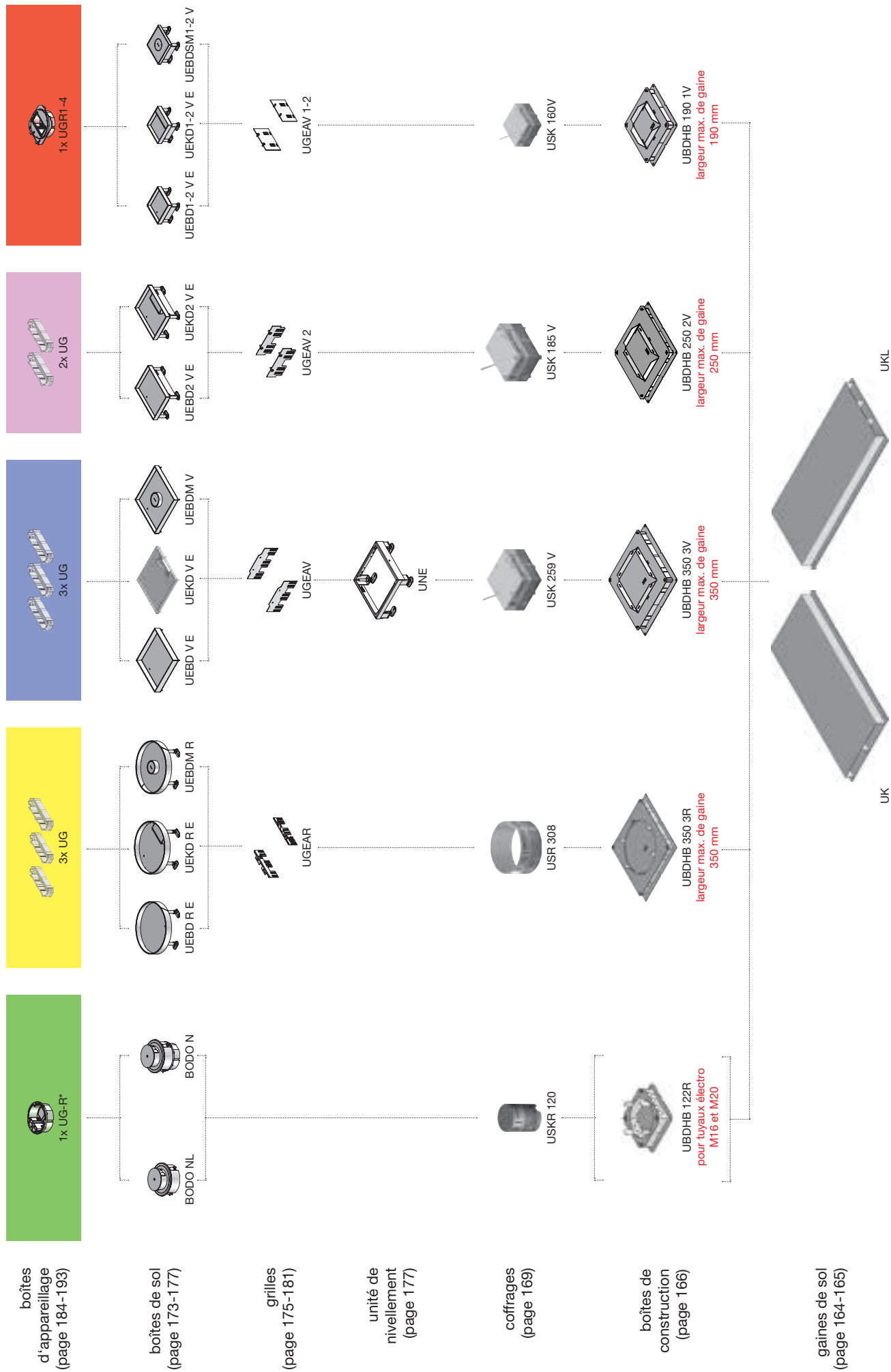

SYSTÈMES DE GAINES DE SOL NOYÉES POUR PARQUET ET CARRELAGE - BOÎTES DE SOL EN ACIER INOXYDABLE

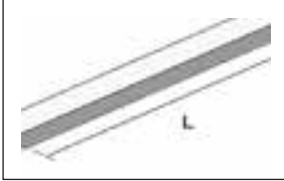
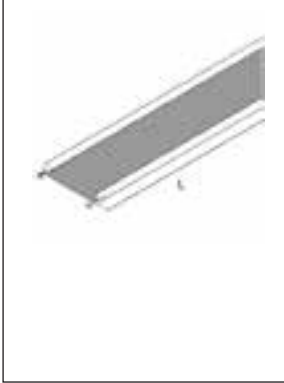

Canaux de sol au ras du sol

	type	référence	 stock	page. catal.	groupe d'articles	prix en €
Système de gaines de sol ouvert						
	Acier galvanisé Sendzimir					
	↔ 2 m	200	UEBS 20S	A04	10407	172,64/m
		300	UEBS 30S	A04	10407	190,23/m
		400	UEBS 40S	A04	10407	207,82/m
Paroi latérale						
	Acier galvanisé Sendzimir					
	↔ 2 m	48-68	UEBSMSP 60S	A07	10407	18,90/m
		88-108	UEBSMSP 100S	A07	10407	23,45/m
Paroi latérale						
	Polyamide					
	↔ 2 m	48-68	UEBSMSP 60	A07	10407	22,15/m
		88-108	UEBSMSP 100	A07	10407	36,48/m
Bac de fond						
	Acier galvanisé Sendzimir					
	↔ 2 m	60-200	UEBSMSW 60-20S	A05	10407	27,36/m
		60-300	UEBSMSW 60-30S	A05	10407	31,92/m
		60-400	UEBSMSW 60-40S	A05	10407	37,13/m
		80-200	UEBSMSW 80-20S	A05	10407	29,30/m
		80-300	UEBSMSW 80-30S	A05	10407	34,52/m
		80-400	UEBSMSW 80-40S	A05	10407	40,40/m
		100-200	UEBSMSW 100-20S	A05	10407	31,92/m
		100-300	UEBSMSW 100-30S	A05	10407	37,13/m
		100-400	UEBSMSW 100-40S	A05	10407	44,95/m
		120-200	UEBSMSW 120-20S	A05	10407	34,52/m
		120-300	UEBSMSW 120-30S	A05	10407	37,13/m
	120-400	UEBSMSW 120-40S	A05	10407	44,95/m	
Pied de nivellement						
	Acier galvanisé Sendzimir					
		60/110	UEBSST 80S	A07	10407	14,33/pc.
		100/150	UEBSST 150S	A08	10407	19,55/pc.
Embout						
	Acier galvanisé Sendzimir					
		60-200	UEBSES 60-20S	A11	10407	27,36/pc.
		60-300	UEBSES 60-30S	A11	10407	29,96/pc.
		60-400	UEBSES 60-40S	A11	10407	32,57/pc.
		100-200	UEBSES 100-20S	A11	10407	28,67/pc.
		100-300	UEBSES 100-30S	A11	10407	31,28/pc.
	100-400	UEBSES 100-40S	A11	10407	33,87/pc.	
Dérivation						
	Acier galvanisé Sendzimir					
		200	UEBSMA 20S	A09	10407	34,66/pc.
		300	UEBSMA 30S	A09	10407	35,32/pc.
		400	UEBSMA 40S	A09	10407	35,96/pc.

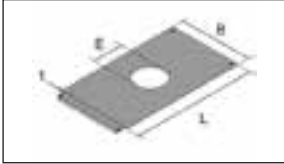
Canaux de sol au ras du sol

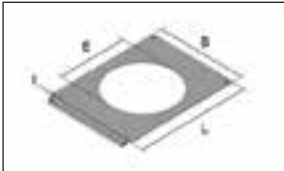
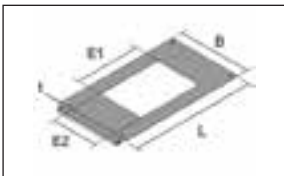
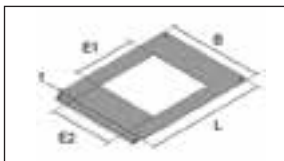
	type	référence	stock	page. catal.	groupe d'articles	prix en €	
	Pièce d'angle						
	Acier galvanisé Sendzimir						
	200	UEBSMB 20S		A09	10407	34,66/pc.	
	300	UEBSMB 30S		A09	10407	35,32/pc.	
	400	UEBSMB 40S		A10	10407	35,96/pc.	
	Couvercle de montage, trou diamètre 122						
	Acier galvanisé Sendzimir						
	↔ 0,5 m	200	UEBSMD-122R 20S		A05	10407	58,64/pc.
		300	UEBSMD-122R 30S		A05	10407	65,15/pc.
	400	UEBSMD-122R 40S		A05	10407	71,68/pc.	
	Couvercle de montage, trou diamètre 260						
	Acier galvanisé Sendzimir						
	↔ 0,5 m	400	UEBSMD-260R 40S		A05	10407	71,68/pc.
	Couvercle de montage, trou diamètre 307						
	Acier galvanisé Sendzimir						
	↔ 0,5 m	400	UEBSMD-307R 40S		A05	10407	71,68/pc.
	Couvercle de montage, trou 185 x 260						
	Acier galvanisé Sendzimir						
	↔ 0,5 m	300	UEBSMD-185V 30S		A06	10407	65,15/pc.
		400	UEBSMD-185V 40S		A06	10407	71,68/pc.
	Couvercle de montage, trou 261 x 261						
	Acier galvanisé Sendzimir						
	↔ 0,5 m	400	UEBSMD-260V 40S		A06	10407	71,68/pc.

Canaux de sol pour charges lourdes

	type	référence	stock	page. catal.	groupe d'articles	prix en €	
Base canal de sol							
	Acier galvanisé Sendzimir						
		↔ 3 m	UBK	UBK 100-20S	A18	10401	52,98/m
			UBK	UBK 100-30S	A18	10401	63,40/m
			UBK	UBK 100-40S	A18	10401	76,88/m
			UBK	UBK 135-20S	A18	10401	58,64/m
			UBK	UBK 135-30S	A18	10401	70,36/m
			UBK	UBK 135-40S	A18	10401	83,83/m
			UBK	UBK 170-20S	A18	10401	65,15/m
			UBK	UBK 170-30S	A18	10401	76,44/m
		UBK	UBK 170-40S	A18	10401	88,59/m	
Couvercle pour canal de sol							
	Acier galvanisé à chaud						
		↔ 1 m	UBKD	UBKD5 25F	A18	10401	327,04/m
			UBKD	UBKD5 35F	A18	10401	368,73/m
			UBKD	UBKD5 45F	A18	10401	413,03/m
			UBKD	UBKD8 25F	A18	10401	392,19/m
			UBKD	UBKD8 35F	A18	10401	463,84/m
			UBKD	UBKD8 45F	A18	10401	530,30/m
			UBKD	UBKD10 25F	A18	10401	432,59/m
			UBKD	UBKD10 35F	A18	10401	525,08/m
		UBKD	UBKD10 45F	A18	10401	609,78/m	
Profilé latéral							
	Acier galvanisé à chaud						
		↔ 3 m	UBKPR	UBKPR5F	A19	10401	63,40/m
			UBKPR	UBKPR8F	A19	10401	82,52/m
		UBKPR	UBKPR10F	A19	10401	99,46/m	
Embout							
	Acier galvanisé Sendzimir						
			UBKEB	UBKEB 100-20S	A20	10401	29,52/pc.
			UBKEB	UBKEB 100-30S	A20	10401	33,75/pc.
			UBKEB	UBKEB 100-40S	A20	10401	35,90/pc.
			UBKEB	UBKEB 135-20S	A20	10401	31,67/pc.
			UBKEB	UBKEB 135-30S	A20	10401	35,90/pc.
			UBKEB	UBKEB 135-40S	A20	10401	37,91/pc.
			UBKEB	UBKEB 170-20S	A20	10401	33,75/pc.
			UBKEB	UBKEB 170-30S	A20	10401	37,91/pc.
		UBKEB	UBKEB 170-40S	A20	10401	40,07/pc.	
Profilé pour courbe intérieure							
	Acier galvanisé à chaud						
			UBKIB	UBKIB5F	A20	10401	147,24/pc.
			UBKIB	UBKIB8F	A20	10401	188,93/pc.
		UBKIB	UBKIB10F	A20	10401	230,63/pc.	
Profilé pour courbe extérieure							
	Acier galvanisé à chaud						
			UBKAB	UBKAB5F	A20	10401	170,69/pc.
			UBKAB	UBKAB8F	A20	10401	222,80/pc.
		UBKAB	UBKAB10F	A20	10401	274,93/pc.	

Canaux de sol pour charges lourdes

	type	référence	stock	page. catal.	groupe d'articles	prix en €
	Accouplement (base canal de sol)					
	Acier galvanisé Sendzimir					
	UBKV	UBKV 100S		A21	10401	2,81/pc.
	UBKV	UBKV 135S		A21	10401	3,65/pc.
	UBKV	UBKV 170S		A21	10401	4,55/pc.
	Teneur de distance					
	Acier galvanisé à chaud					
	UBKDB	UBKDB5 25F		A21	10401	4,31/pc.
	UBKDB	UBKDB5 35F		A21	10401	4,89/pc.
	UBKDB	UBKDB5 45F		A21	10401	6,26/pc.
	UBKDB	UBKDB8 25F		A21	10401	4,55/pc.
	UBKDB	UBKDB8 35F		A21	10401	5,35/pc.
	UBKDB	UBKDB8 45F		A21	10401	6,60/pc.
	Cloison de séparation					
	Acier galvanisé Sendzimir					
		UBKTR	UBKTR 100S		A14	10401 sur demande
		UBKTR	UBKTR 135S		A14	10401 sur demande
	UBKTR	UBKTR 170S		A14	10401 sur demande	



Gaines de sol noyées fermées

	type	référence	stock	page. catal.	groupe d'articles	prix en €
Gaine de sol fermée, 2 compartiments						
	Acier galvanisé Sendzimir					
		↔ 3 m				
	UK	UK 2-28-190S	✓	B04	10403	45,61/m
	UK	UK 2-28-250S	✓	B04	10403	49,52/m
	UK	UK 2-28-350S	✓	B04	10403	69,06/m
	UK	UK 2-38-190S	✓	B04	10403	47,77/m
	UK	UK 2-38-250S	✓	B04	10403	52,11/m
	UK	UK 2-38-350S	✓	B04	10403	70,81/m
	UK	UK 2-48-190S		B04	10403	49,07/m
	UK	UK 2-48-250S		B04	10403	53,86/m
	UK	UK 2-48-350S		B04	10403	72,53/m
Gaine de sol fermée, 3 compartiments						
	Acier galvanisé Sendzimir					
		↔ 3 m				
	UKL	UKL 3-28-250S		B04	10403	50,81/m
	UKL	UKL 3-28-350S		B04	10403	69,50/m
	UKL	UKL 3-38-250S	✓	B04	10403	56,89/m
	UKL	UKL 3-38-350S	✓	B04	10403	71,68/m
	UKL	UKL 3-48-250S	✓	B04	10403	62,54/m
	UKL	UKL 3-48-350S	✓	B04	10403	73,84/m
Etrier de fixation						
	Acier galvanisé Sendzimir					
	UB	UB 28-190S	✓	B05	10403	7,42/pc.
	UB	UB 28-250S	✓	B05	10403	7,62/pc.
	UB	UB 28-350S	✓	B05	10403	8,54/pc.
	UB	UB 38-190S	✓	B05	10403	7,62/pc.
	UB	UB 38-250S	✓	B05	10403	7,75/pc.
	UB	UB 38-350S	✓	B05	10403	8,54/pc.
	UB	UB 48-190S		B05	10403	7,75/pc.
	UB	UB 48-250S	✓	B05	10403	8,01/pc.
	UB	UB 48-350S	✓	B05	10403	8,73/pc.
Pièce de montée, 2 compartiments						
	Acier galvanisé Sendzimir					
	UVB	UVB 2-28-190S	✓	B05	10403	57,58/pc.
	UVB	UVB 2-28-250S	✓	B05	10403	62,36/pc.
	UVB	UVB 2-28-350S	✓	B05	10403	69,97/pc.
	UVB	UVB 2-38-190S	✓	B05	10403	58,71/pc.
	UVB	UVB 2-38-250S	✓	B05	10403	63,01/pc.
	UVB	UVB 2-38-350S	✓	B05	10403	70,68/pc.
	UVB	UVB 2-48-190S		B05	10403	61,44/pc.
	UVB	UVB 2-48-250S		B05	10403	66,06/pc.
	UVB	UVB 2-48-350S		B05	10403	73,82/pc.
Pièce de montée, 3 compartiments						
	Acier galvanisé Sendzimir					
	UVB	UVB 3-28-250S		B05	10403	69,13/pc.
	UVB	UVB 3-28-350S		B05	10403	82,62/pc.
	UVB	UVB 3-38-250S	✓	B05	10403	74,27/pc.
	UVB	UVB 3-38-350S	✓	B05	10403	86,65/pc.
	UVB	UVB 3-48-250S	✓	B05	10403	78,83/pc.
	UVB	UVB 3-48-350S	✓	B05	10403	99,36/pc.

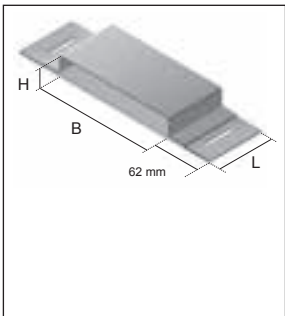
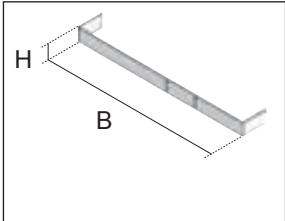
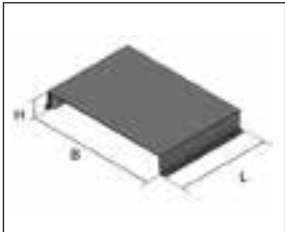
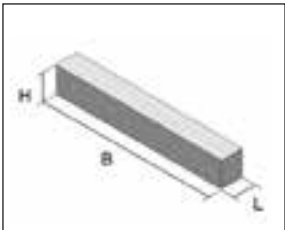
Gaines de sol noyées fermées

	type	référence	stock	page. catal.	groupe d'articles	prix en €	
	Manchon de fixation						
	Acier galvanisé Sendzimir						
	UM	UM 28-190S		B06	10403	12,11/pc.	
	UM	UM 28-250S		B06	10403	12,84/pc.	
	UM	UM 28-350S		B06	10403	14,27/pc.	
	UM	UM 38-190S		B06	10403	12,31/pc.	
	UM	UM 38-250S		B06	10403	13,10/pc.	
	UM	UM 38-350S		B06	10403	14,60/pc.	
	UM	UM 48-190S		B06	10403	12,57/pc.	
	UM	UM 48-250S		B06	10403	13,21/pc.	
	UM	UM 48-350S		B06	10403	14,71/pc.	
À utiliser aux endroits avec joints d'expansion.							
	Embout						
	Acier galvanisé Sendzimir						
	UE	UE 28-350S		B06	10403	14,60/pc.	
	UE	UE 38-350S		B06	10403	16,54/pc.	
	UE	UE 48-350S		B06	10403	19,16/pc.	
	Cloison anti-incendie						
	Acier galvanisé Sendzimir						
		28-350	UKBS 28-350S		B11	10402	549,84/pc.
		38-350	UKBS 38-350S		B11	10402	573,29/pc.
	48-350	UKBS 48-350S		B11	10402	599,36/pc.	
	Bouchon en mousse Easyfoam						
	Polycarbonate						
		30-390	UKBSR 28-350S		B11	10402	22,61/pc.
		40-390	UKBSR 38-350S		B11	10402	23,60/pc.
	50-390	UKBSR 48-350S		B11	10402	24,75/pc.	

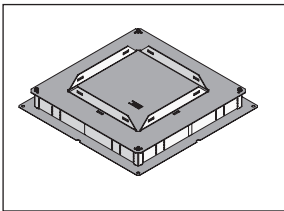
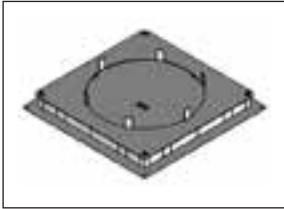
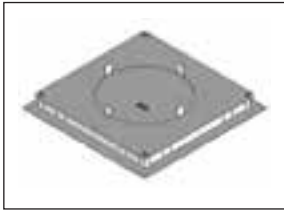
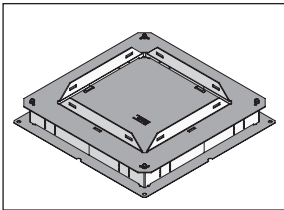
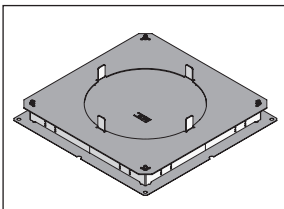
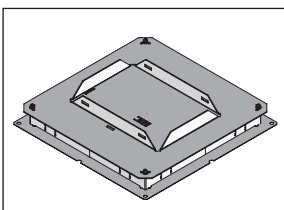
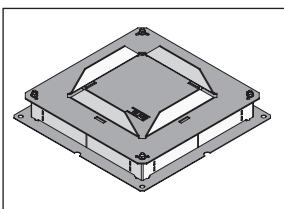
Boîtes de construction vides

	type	référence	 stock	page. catal.	groupe d'articles	prix en €
	Boîte de construction vide					
	Acier galvanisé Sendzimir	262x262	UBDHB350 28-259V	✓	B07	10402 121,56/pc.
		262x262	UBDHB350 38-259V	✓	B07	10402 125,74/pc.
		262x262	UBDHB350 48-259V	✓	B07	10402 132,91/pc.
	Boîte de construction vide					
	Acier galvanisé Sendzimir	Ø310	UBDHB350 28-308R	✓	B07	10402 125,03/pc.
		Ø310	UBDHB350 38-308R		B07	10402 129,51/pc.
	Ø310	UBDHB350 48-308R	B07		10402 134,20/pc.	
	Boîte de construction vide					
	Acier galvanisé Sendzimir	Ø260	UBDHB350 28-259R		B08	10402 121,08/pc.
		Ø260	UBDHB350 38-259R		B08	10402 125,91/pc.
		Ø260	UBDHB350 48-259R		B08	10402 130,52/pc.
	Boîte de construction vide					
	Acier galvanisé Sendzimir	262x262	UBDHB250 28-259V	✓	B08	10402 112,14/pc.
		262x262	UBDHB250 38-259V	✓	B08	10402 115,25/pc.
		262x262	UBDHB250 48-259V		B08	10402 118,39/pc.
	Boîte de construction vide					
	Acier galvanisé Sendzimir	Ø260	UBDHB250 28-259R		B09	10402 112,97/pc.
		Ø260	UBDHB250 38-259R		B09	10402 116,17/pc.
		Ø260	UBDHB250 48-259R		B09	10402 119,16/pc.
	Boîte de construction vide					
	Acier galvanisé Sendzimir	187x262	UBDHB250 28-185V	✓	B09	10402 103,65/pc.
		187x262	UBDHB250 38-185V	✓	B09	10402 107,10/pc.
		187x262	UBDHB250 48-185V		B09	10402 110,75/pc.
	Boîte de construction vide					
	Acier galvanisé Sendzimir	165x165	UBDHB190 28-160V	✓	B10	10402 98,77/pc.
		165x165	UBDHB190 38-160V	✓	B10	10402 99,54/pc.
		165x165	UBDHB190 48-160V		B10	10402 100,33/pc.
	Boîte de construction vide					
	Acier galvanisé Sendzimir	Ø123	UBDHB 38-122R	✓	B10	10406 66,97/pc.



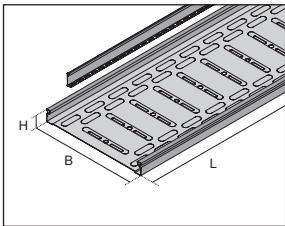
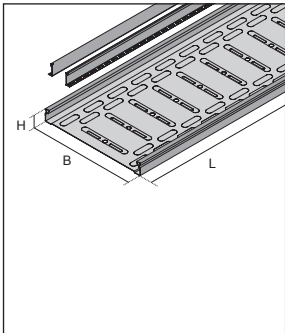
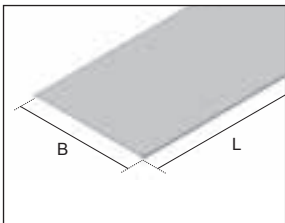
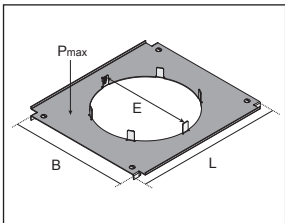
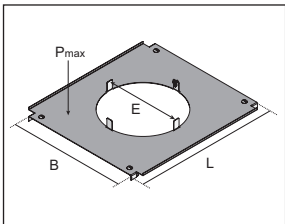
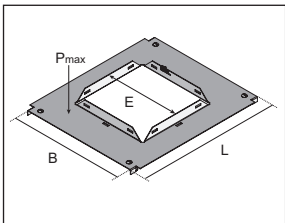
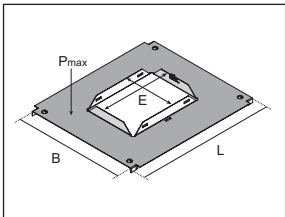

Canaux de sol avec couvercle

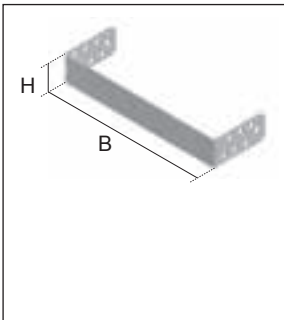
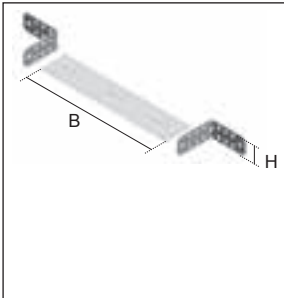
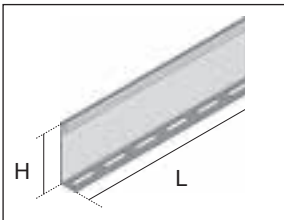
	type	référence	 stock	page. catal.	groupe d'articles	prix en €	
	Base canal de sol, 2 compartiments						
	Acier galvanisé Sendzimir	UKR	UKR 35-30S		B14	10402	24,44/m
	↔ 3 m						
	Base canal de sol, 3 compartiments						
	Acier galvanisé Sendzimir	UKR	UKR 35-40S	✓	B14	10402	27,86/m
	↔ 3 m	UKR	UKR 35-50S	✓	B14	10402	34,22/m
		UKR	UKR 60-40S	✓	B14	10402	40,78/m
		UKR	UKR 60-50S	✓	B14	10402	46,91/m
		UKR	UKR 85-40S		B14	10402	59,07/m
		UKR	UKR 85-50S		B14	10402	65,15/m
		UKR	UKR 110-40S		B14	10402	63,84/m
	UKR	UKR 110-50S		B14	10402	76,88/m	
	Couvercle pour canal de sol						
	Acier galvanisé Sendzimir	UKD	UKD 30S		B14	10402	25,54/m
	↔ 3 m	UKD	UKD 40S	✓	B14	10402	29,32/m
		UKD	UKD 50S	✓	B14	10402	35,38/m
	Couvercle de montage						
	Acier galvanisé Sendzimir	Ø310	UKDA-308R 40S		B15	10402	61,37/pc.
		Ø310	UKDA-308R 50S		B15	10402	68,62/pc.
	Couvercle de montage						
	Acier galvanisé Sendzimir	Ø260	UKDA-260R 30S		B15	10402	54,85/pc.
		Ø260	UKDA-260R 40S		B15	10402	60,47/pc.
		Ø260	UKDA-260R 50S		B15	10402	67,88/pc.
	Couvercle de montage						
	Acier galvanisé Sendzimir	262x262	UKDA-260V 40S	✓	B15	10402	61,04/pc.
		262x262	UKDA-260V 50S	✓	B15	10402	68,27/pc.
	Couvercle de montage						
	Acier galvanisé Sendzimir	187x262	UKDA-185V 30S		B16	10402	46,21/pc.
		187x262	UKDA-185V 40S		B16	10402	53,68/pc.

Canaux de sol avec couvercle

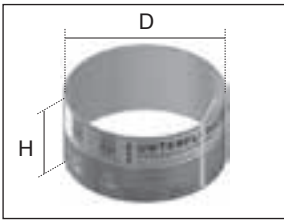
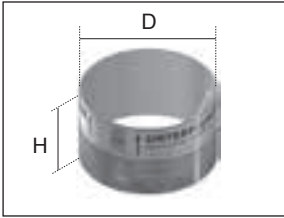
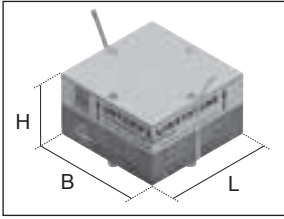
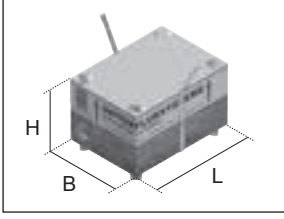
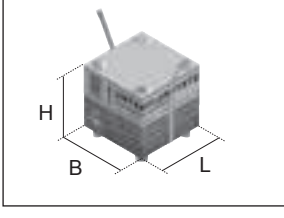
	type	référence	stock	page. catal.	groupe d'articles	prix en €	
Embout							
	Acier galvanisé Sendzimir						
	UKEB	UKEB 35-30S		B16	10402	4,63/pc.	
	UKEB	UKEB 35-40S	✓	B16	10402	5,21/pc.	
	UKEB	UKEB 35-50S		B16	10402	6,90/pc.	
	UKEB	UKEB 60-40S		B16	10402	7,81/pc.	
	UKEB	UKEB 60-50S		B16	10402	9,50/pc.	
	UKEB	UKEB 85-40S		B16	10402	10,82/pc.	
	UKEB	UKEB 85-50S		B16	10402	13,42/pc.	
	UKEB	UKEB 110-40S		B16	10402	14,71/pc.	
UKEB	UKEB 110-50S		B16	10402	16,42/pc.		
Dérivation							
	Acier galvanisé Sendzimir						
	UKAZ	UKAZ 35-30S		B16	10402	sur demande	
	UKAZ	UKAZ 35-40S	✓	B16	10402	12,11/pc.	
	UKAZ	UKAZ 35-50S		B16	10402	12,84/pc.	
	UKAZ	UKAZ 60-40S		B16	10402	12,71/pc.	
	UKAZ	UKAZ 60-50S		B16	10402	14,16/pc.	
	UKAZ	UKAZ 85-40S		B16	10402	19,55/pc.	
	UKAZ	UKAZ 85-50S		B16	10402	19,55/pc.	
	UKAZ	UKAZ 110-40S		B16	10402	20,02/pc.	
UKAZ	UKAZ 110-50S		B16	10402	20,79/pc.		
Cloison de séparation							
	Acier galvanisé Sendzimir						
	↔ 3 m	UKTR	UKTR 35S		B17	10402	3,79/m
		UKTR	UKTR 60S		B17	10402	11,21/m
		UKTR	UKTR 85S		B17	10402	10,96/m
		UKTR	UKTR 110S		B17	10402	13,47/m

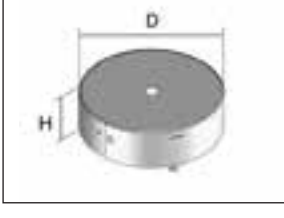



Coffrages

	type	référence	stock	page. catal.	groupe d'articles	prix en €
	Tube de coffrage					
	Carton	Ø308 USR 308-150 Ø308 USR 308-225	✓	B18 B18	10402 10402	13,81/pc. 24,63/pc.
	Tube de coffrage					
	Carton	Ø259 USR 259-150		B18	10402	12,71/pc.
	Corps de coffrage					
	Polystyrène	261x261 USK 259V-150 261x261 USK 259V-225	✓ ✓	B18 B18	10402 10402	16,75/pc. 26,00/pc.
	Corps de coffrage					
	Polystyrène	186x261 USK 185V-150	✓	B18	10402	13,42/pc.
	Corps de coffrage					
	Polystyrène	164x164 USK 160V-150	✓	B18	10402	11,27/pc.
	Corps de coffrage					
	Polystyrène	Ø122 USK 120R-82 Ø122 USK 120R-150	✓	B18 B18	10406 10406	6,65/pc. 8,13/pc.
	Tube de coffrage, rond, résistant à la chaleur					
	Acier galvanisé Sendzimir	Ø307 UNSKH 308R-100S		B18	10402	117,11/pc.
	Corps de coffrage, carré, résistant à la chaleur					
	Acier galvanisé Sendzimir	259x259 UNSKH 260V-100S		B19	10402	91,09/pc.

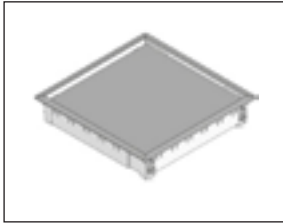
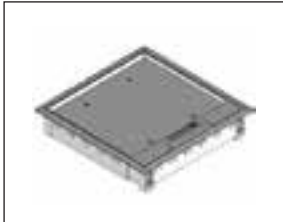

Accessoires

	type	référence	 stock	page. catal.	groupe d'articles	prix en €
	Cheville à frapper Acier galvanisé cheville en PVC	UN 5/38	✓	B20	10402	13,85/bt.
	1 boîte = 50 pièces					
	Cheville à frapper Acier galvanisé cheville en acier	SNA 6x30/5	✓	B20	10402	173,30/bt.
	1 boîte = 100 pièces					
	Ruban adhésif avec tissu	UGKB		B20	10402	31,80/pc.
	1 pc. = 50 m					
	Adhésif bitumes	UBKM		B20	10402	sur demande
	Languette de terre Acier galvanisé Sendzimir	UBDEL		B20	10402	11,16/pc.
	Borne de terre Acier galvanisé Sendzimir	UBDHB-Z		B20	10402	2,21/pc.

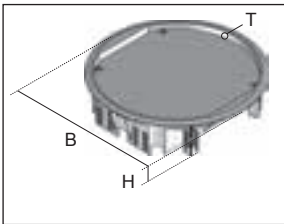
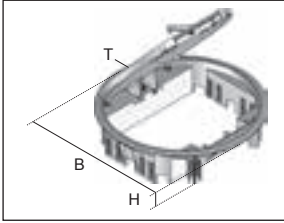
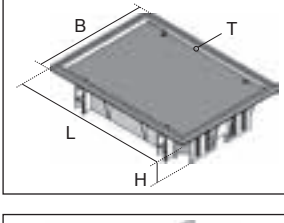
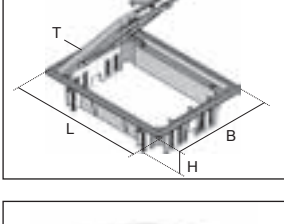
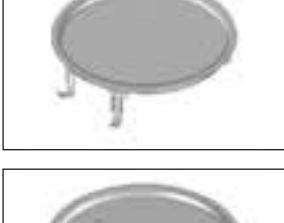
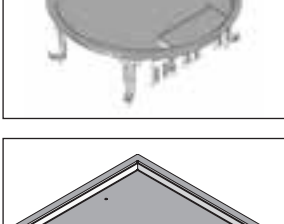
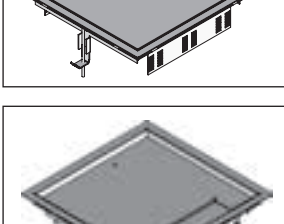

Boîtes de sol avec rebord

	type	référence	 stock	page. catal.	groupe d'articles	prix en €
	Boîte de tirage triple, ronde					
	Polyamide					
	gris	UEB3-R-G		C04	10402	47,14/pc.
	noir	UEB3-R-S		C04	10402	47,14/pc.
	Boîte de raccordement triple, ronde, sortie avec brosse					
	Polyamide					
	gris	UEK3-R-G		C04	10402	71,13/pc.
	noir	UEK3-R-S		C04	10402	71,13/pc.
	Boîte de tirage triple, carrée					
	Polyamide					
	gris	UEB3-V-G	✓	C06	10402	44,86/pc.
	noir	UEB3-V-S	✓	C06	10402	44,86/pc.
	Boîte de raccordement triple, carrée, sortie avec brosse					
	Polyamide					
	gris	UEK3-V-G	✓	C06	10402	58,64/pc.
	noir	UEK3-V-S	✓	C06	10402	58,64/pc.
	Set de montage pour boîte de raccordement, sortie avec brosse					
	Acier galvanisé Sendzimir					
	UGE3	UGE3-50-S	✓	C08	10402	10,94/set
	UGE3	UGE3-80-S	✓	C08	10402	12,90/set



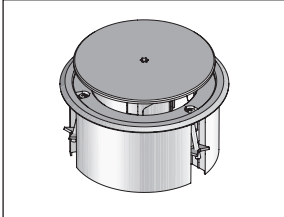

Boîtes de sol avec rebord

	type	référence	 stock	page. catal.	groupe d'articles	prix en €
	Boîte de tirage double, ronde					
	Polyamide	gris noir	UEBD2-R-G UEBD2-R-S	C05 C05	10402	34,61/pc. 34,61/pc.
	Boîte de raccordement double, ronde					
	Polyamide	gris noir	UEKD2-R-G UEKD2-R-S	C06 C06	10402	54,33/pc. 54,33/pc.
	Boîte de tirage double, rectangulaire					
	Polyamide	gris noir	UEBD2-V-G UEBD2-V-S	C07 C07	10402	37,78/pc. 37,78/pc.
	Boîte de raccordement double, rectangulaire					
	Polyamide	gris noir	UEKD2-V-G UEKD2-V-S	✓ ✓	C07 C07	10402 10402
	Boîte de tirage triple, ronde					
	INOX	12 mm	UEBDD 15-R E		C14	10402 380,25/pc.
	Boîte de raccordement triple, ronde					
	INOX	12 mm	UEKDD 15-R E		C14	10402 484,29/pc.
	Boîte de tirage triple, carrée					
	INOX	12 mm 22 mm	UEBDD 15-V E UEBDD 25-V E		C16 C16	10402 333,56/pc. 10402 355,71/pc.
	Boîte de raccordement triple, carrée					
	INOX	12 mm 22 mm	UEKDD 15-V E UEKDD 25-V E	✓ ✓	C17 C17	10402 368,73/pc. 10402 390,88/pc.

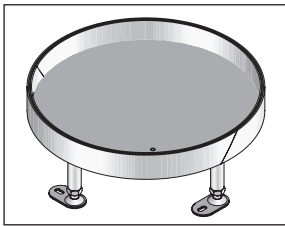
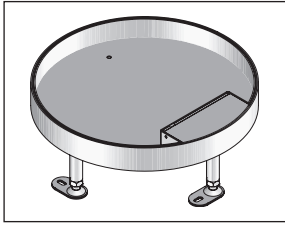
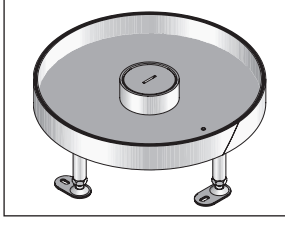

Boîtes de sol avec rebord

	type	référence	stock	page. catal.	groupe d'articles	prix en €
	Boîte de tirage double, rectangulaire					
	INOX	12 mm 22 mm	UEBDD2 15-V E UEBDD2 25-V E		C15 C15	10402 247,57/pc. 10402 257,98/pc.
	Boîte de raccordement double, rectangulaire					
	INOX	12 mm 22 mm	UEKDD2 15-V E UEKDD2 25-V E	✓	C17 C17	10402 349,20/pc. 10402 371,34/pc.
	Boîte de tirage, carrée					
	INOX	12 mm 22 mm	UEBDD1-2 15-V E UEBDD1-2 25-V E		C15 C15	10402 148,54/pc. 10402 151,16/pc.
	Boîte de raccordement, carrée					
	INOX	12 mm 22 mm	UEKDD1-2 15-V E UEKDD1-2 25-V E		C16 C16	10402 191,52/pc. 10402 207,16/pc.
	Boîte de raccordement BODO, ronde					
	Aluminium		BODO NL	✓	C41	10406 327,29/pc.
		noir	BODO NL-SW		C41	10406 441,72/pc.
		chromé	BODO NL-CR		C41	10406 599,60/pc.
	Acier inoxydable	massif	BODO NL-E		C41	10406 1339,99/pc.
Laiton	massif	BODO NL-MMS		C41	10406 1086,21/pc.	
	Boîte de raccordement BODO, ronde					
	ABS	gris	BODO TL-G	✓	C42	10406 56,78/pc.
		noir	BODO TL-S	✓	C42	10406 56,78/pc.



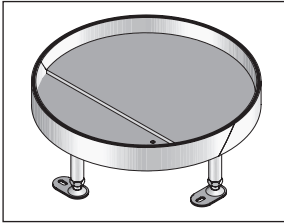
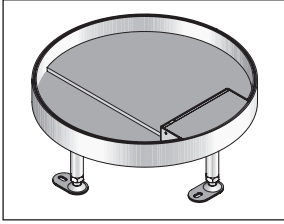
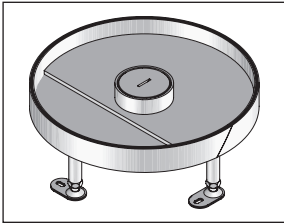
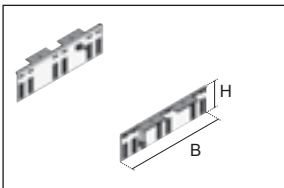

Boîtes de sol avec rebord de marquage

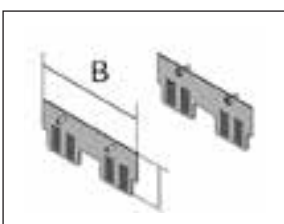
	type	référence	 stock	page. catal.	groupe d'articles	prix en €
	Cassette de nivellement + couvercle aveugle, rond					
	INOX					
	2 kN	UEBD 15-R E		C20	10402	371,34/set
	2 kN	UEBD 35-R E		C20	10402	426,06/set
	Cassette de nivellement + couvercle avec sortie latérale, rond					
	INOX					
	2 kN	UEKD 15-R E		C21	10402	452,12/set
	2 kN	UEKD 35-R E		C21	10402	517,27/set
	Cassette de nivellement + couvercle avec sortie centrale, rond					
	INOX					
	2 kN	UEBDM 15-R-WD		C23	10402	466,45/set
	2 kN	UEBDM 35-R-WD		C23	10402	540,72/set
	Cassette de nivellement + couvercle rempli, aveugle, rond					
	INOX					
	4 kN	UEBD 15-RP E		C21	10402	543,33/set
	Cassette de nivellement + couvercle rempli avec sortie latérale, rond					
	INOX					
	4 kN	UEKD 15-RP E		C22	10402	625,41/set
	Cassette de nivellement + couvercle rempli avec sortie centrale, rond					
	INOX					
	4 kN	UEBDM 15-RP-WD		C24	10402	720,52/set

Boîtes de sol avec rebord de marquage

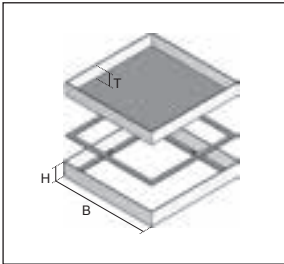
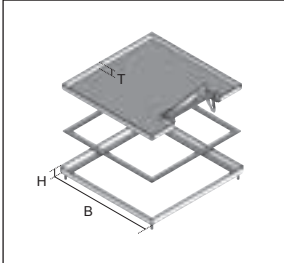
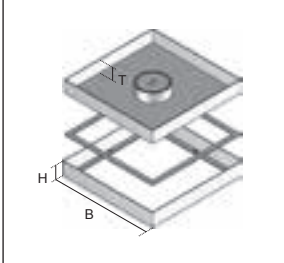
	type	référence	 stock	page. catal.	groupe d'articles	prix en €
	Cassette de nivellement + couvercle aveugle, rond					
	INOX	20 kN	UEBDS 35-R6 E		C20	10402 558,96/set
	Cassette de nivellement + couvercle avec sortie latérale, rond					
	INOX	10 kN	UEKDS 35-R6 E		C22	10402 646,27/set
	Cassette de nivellement + couvercle avec sortie centrale, rond					
	INOX	20 kN	UEBDSM 35-R6-WD		C23	10402 664,52/set
	Set de montage, ronde					
	Acier galvanisé Sendzimir	UGEAR	UGEAR-50S	✓	C24	10402 38,76/set
		UGEAR	UGEAR-80S		C24	10402 40,78/set
	Cassette de nivellement + couvercle aveugle, rectangulaire					
	INOX	1,5 kN	UEBD2 15-V E		C26	10402 201,97/pc.
		1,5 kN	UEBD2 25-V E		C26	10402 218,88/pc.
	Cassette de nivellement + couvercle avec sortie latérale, rectangulaire					
	INOX	1,5 kN	UEKD2 15-V E		C28	10402 280,14/pc.
		1,5 kN	UEKD2 25-V E		C28	10402 306,20/pc.
	Set de montage, rectangulaire					
	Acier galvanisé Sendzimir	UGEAV	UGEAV2-50S	✓	C33	10402 10,94/set
		UGEAV	UGEAV2-80S		C33	10402 16,57/set



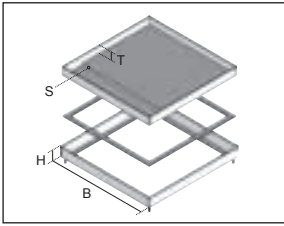
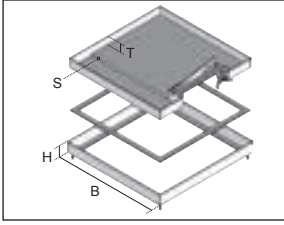
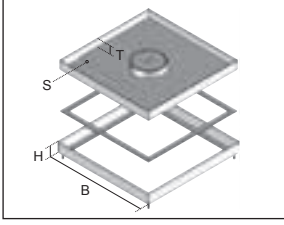
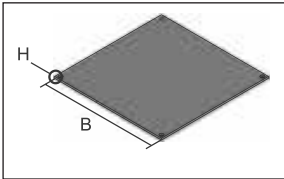
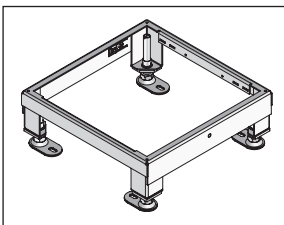
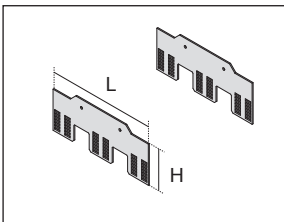

Boîtes de sol avec rebord de marquage

	type	référence	stock	page. catal.	groupe d'articles	prix en €	
	Cassette + couvercle aveugle, carré						
	INOX	2 kN	UEBD 15-V E	✓	C27	10402	177,20/set
		2 kN	UEBD 25-V E	✓	C27	10402	188,93/set
		2 kN	UEBD 35-V E		C27	10402	225,41/set
		2 kN	UEBD 45-V E		C27	10402	246,24/set
	Laiton	2 kN	UEBD 25-V MS		C27	10402	398,91/set
	2 kN	UEBD 35-V MS		C27	10402	431,03/set	
	Cassette + couvercle avec sortie latérale, carré						
	INOX	2 kN	UEKD 15-V E	✓	C29	10402	251,47/set
		2 kN	UEKD 25-V E	✓	C29	10402	265,80/set
		2 kN	UEKD 35-V E		C29	10402	285,35/set
		2 kN	UEKD 45-V E		C29	10402	306,20/set
	Laiton	2 kN	UEKD 25-V MS		C29	10402	540,95/set
	2 kN	UEKD 35-V MS		C29	10402	524,89/set	
	Cassette + couvercle avec sortie centrale, carré						
	INOX	2 kN	UEBDM 15-V-WD	✓	C30	10402	278,83/set
		2 kN	UEBDM 25-V-WD	✓	C30	10402	320,52/set
		2 kN	UEBDM 35-V-WD	✓	C30	10402	332,25/set
		2 kN	UEBDM 45-V-WD	✓	C30	10402	340,07/set
	Laiton	2 kN	UEBDM 25-V-WD MS		C30	10402	540,95/set
	2 kN	UEBDM 35-V-WD MS		C30	10402	631,09/set	
	Cassette + couvercle aveugle, rempli, carré						
	INOX	4 kN	UEBD 15-VP E		C28	10402	287,95/set
	Cassette + couvercle rempli avec sortie latérale, carré						
	INOX	4 kN	UEKD 15-VP E		C30	10402	366,12/set
	Cassette + couvercle rempli avec sortie centrale, carré						
	INOX	4 kN	UEBDM 15-VP-WD		C31	10402	456,04/set
		20 kN	UEBDSM 15-VP8-WD		C32	10402	559,81/set



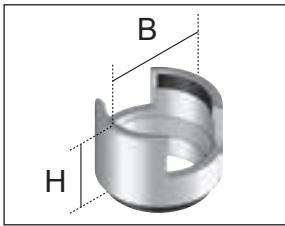



Boîtes de sol avec rebord de marquage

	type	référence	 stock	page. catal.	groupe d'articles	prix en €
	Cassette + couvercle aveugle, carré					
	INOX					
	10 kN	UEBDS 25-V6 E		C27	10402	230,63/set
	10 kN	UEBDS 35-V6 E		C27	10402	268,40/set
	10 kN	UEBDS 45-V6 E		C27	10402	289,25/set
	20 kN	UEBDS 35-V8 E		C27	10402	271,00/set
	20 kN	UEBDS 45-V8 E		C27	10402	291,86/set
	Cassette + couvercle avec sortie latérale, carré					
	INOX					
	10 kN	UEKDS 25-V6 E		C29	10402	307,50/set
	10 kN	UEKDS 35-V6 E		C29	10402	327,04/set
	10 kN	UEKDS 45-V6 E		C29	10402	347,88/set
	Cassette + couvercle avec sortie centrale, carré					
	INOX					
	10 kN	UEBDSM 25-V6-WD		C31	10402	379,16/set
	10 kN	UEBDSM 35-V6-WD		C31	10402	388,28/set
	10 kN	UEBDSM 45-V6-WD		C31	10402	405,22/set
	20 kN	UEBDSM 35-V8-WD		C31	10402	392,19/set
	20 kN	UEBDSM 45-V8-WD		C31	10402	410,43/set
	Plaque aveugle, carrée					
	Acier galvanisé Sendzimir		UBP-V 4S		C26	10402
	Unité de nivellement, aveugle					
	Acier galvanisé Sendzimir					
	UNE	UNE 260V-30S	✓	C32	10402	85,54/pc.
	UNE	UNE 260V-60S	✓	C32	10402	87,38/pc.
	UNE	UNE 260V-100S	✓	C32	10402	90,10/pc.
	UNE	UNE 260V-155S	✓	C32	10402	101,10/pc.
UNE	UNE 260V-210S	✓	C32	10402	122,28/pc.	
	Set de montage, carré					
	Acier galvanisé Sendzimir					
	UGEAV	UGEAV-50S	✓	C33	10402	10,94/set
	UGEAV	UGEAV-80S	✓	C33	10402	12,90/set



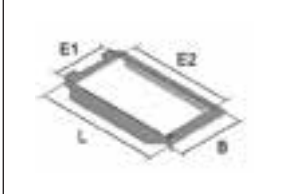
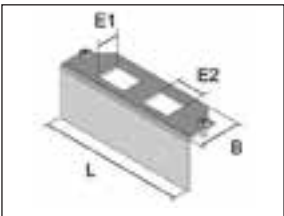
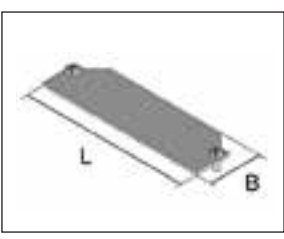

Boîtes de sol avec rebord de marquage

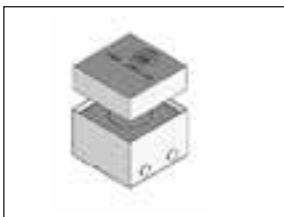
	type	référence	 stock	page. catal.	groupe d'articles	prix en €
	Cylindre					
	Aluminium	naturel	UET-R-WD	✓	C35	10402 87,29/pc.
	Aluminium	laiton	UET-R-WD-MS		C35	10402 96,95/pc.
	INOX	massif	UET-R-WD E		C35	10402 235,83/pc.
	Couvercle pour cylindre					
	Aluminium	naturel	UETD-R-WD		C35	10402 86,33/pc.
	Laiton	massif	UETD-R-WD-MMS		C35	10402 169,78/pc.
	INOX	massif	UETD-R-WD E		C35	10402 168,07/pc.
	Cylindre					
	Aluminium	UET112	UET112-R-WD		C35	10402 97,19/pc.
	Couvercle pour cylindre					
	Aluminium	UETD112	UETD112-R-WD		C35	10402 92,63/pc.
	Ventouse					
		USH	USH 40		C37	10402 43,20/pc.

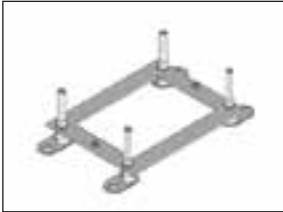
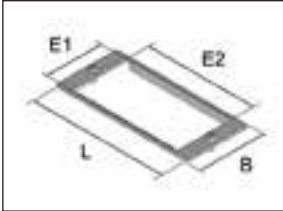
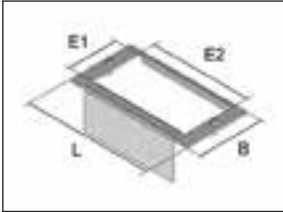
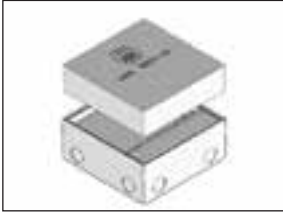

Boîtes de sol complètes avec rebord de marquage

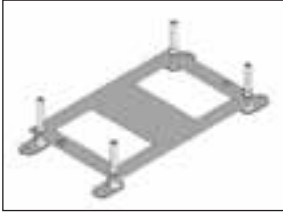
	type	référence	 stock	page. catal.	groupe d'articles	prix en €
Boîte de construction, coffrage et boîte de sol avec sortie latérale						
	INOX	125x125	UKE125 15-V E	✓	C56	10402 286,64/pc.
		125x125	UKE125 25-V E	✓	C56	10402 312,71/pc.
	Laiton	125x125	UKE125 25-V MS		C56	10402 482,08/pc.
Boîte de construction, coffrage et boîte de sol avec sortie centrale						
	INOX	125x125	UKE125 15-VP-WD	✓	C56	10402 410,43/pc.
Plateau de nivellement						
	Acier	25-70	UKENP 125S	✓	C61	10402 54,72/pc.
Support d'appareillage pour 2 modules (45x45)						
	Acier	UEP	UEP125-UST 2	✓	C61	10408 6,26/pc.
Support d'appareillage avec cloison de séparation pour 2 modules Keystone RJ45						
	Acier	UEP	UEP125-KS 2	✓	C61	10408 4,95/pc.
Support d'appareillage aveugle						
	Acier	UEP	UEP125-B	✓	C61	10408 2,46/pc.
Boîte de construction, coffrage et boîte de sol avec sortie latérale						
	INOX	160x160	UKE160 15-V E	✓	C58	10402 312,71/pc.
		160x160	UKE160 25-V E	✓	C58	10402 351,80/pc.
	Laiton	160x160	UKE160 25-V MS		C58	10402 527,68/pc.
Boîte de construction, coffrage et boîte de sol avec sortie centrale						
	INOX	160x160	UKE160 15-VP-WD	✓	C58	10402 429,97/pc.

Boîtes de sol complètes avec rebord de marquage

	type	référence	 stock	page. catal.	groupe d'articles	prix en €
	Plateau de nivellement					
Acier	25-70	UKENP 160S	✓	C62	10402	57,47/pc.
	Support d'appareillage pour 2 modules (45x45)					
Acier	UEP	UEP160-UST 2	✓	C61	10408	6,26/pc.
	Support d'appareillage avec cloison de séparation pour 2 modules 45x45					
Acier	UEP	UEP160-UST 2-TR	✓	C61	10408	9,25/pc.
	Boîte de construction, coffrage et boîte de sol avec sortie latérale					
INOX	160x160	UKEF160 15-V E		C57	10402	284,36/pc.
	Boîte de construction, coffrage et boîte de sol avec sortie latérale					
INOX	184x258	UKE185 15-V E		C59	10402	368,70/pc.
	184x258	UKE185 25-V E		C59	10402	397,62/pc.
	Plateau de nivellement					
Acier	25-70	UKENP 185S		C62	10402	52,00/pc.
	Boîte de construction, coffrage et boîte de sol avec sortie latérale					
INOX	258x258	UKE260 15-V E		C60	10402	379,54/pc.
	258x258	UKE260 25-V E		C60	10402	409,66/pc.
	Plateau de nivellement					
Acier	25-70	UKENP 260S		C62	10402	53,97/pc.

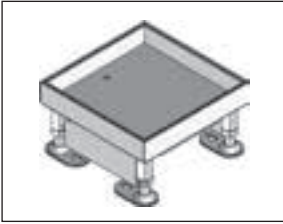
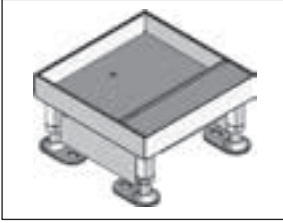

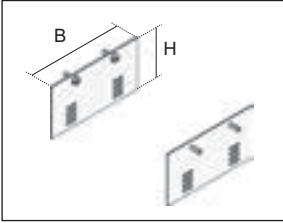
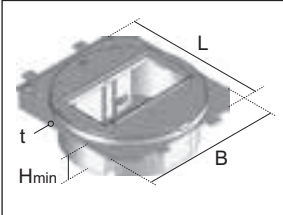
Boîtes de sol avec rebord de marquage

	type	référence	stock	page. catal.	groupe d'articles	prix en €
	Cassette de nivellement + couvercle aveugle (2x 45x45)					
	INOX	160x160	UEBD1-2 15-V E	C51	10402	162,87/pc.
		160x160	UEBD1-2 25-V E	C51	10402	173,30/pc.
	Cassette de nivellement + couvercle avec sortie latérale (2x 45x45)					
	INOX	160x160	UEKD1-2 15-V E	C51	10402	214,99/pc.
		160x160	UEKD1-2 25-V E	C51	10402	233,23/pc.
	Cassette de nivellement + couvercle avec sortie centrale (2x 45x45)					
	INOX	160x160	UEBDSM1-2 15-V8-WD	✓	C52	10402 319,22/pc.
	Set de montage, carré					
	Acier galvanisé Sendzimir	UGEAV	UGEAV1-2 50S	✓	C52	10402 10,94/set
		UGEAV	UGEAV1-2 80S		C52	10402 13,25/set
	Boîte d'appareillage ronde prémontée					
	Acier galvanisé Sendzimir	160x160	UGR1-4	✓	C52	10408 42,61/set

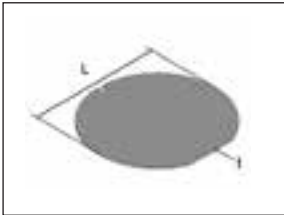
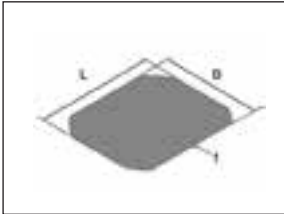
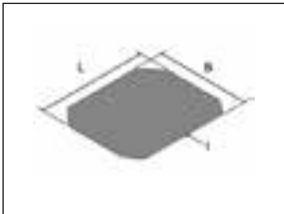
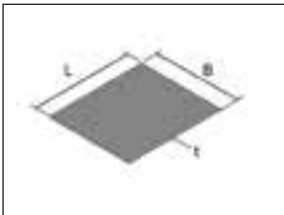
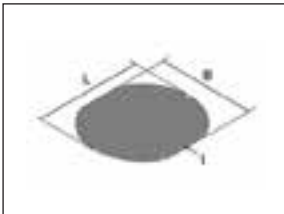
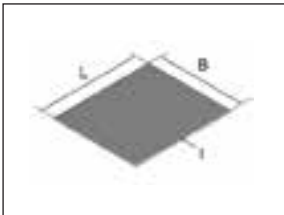
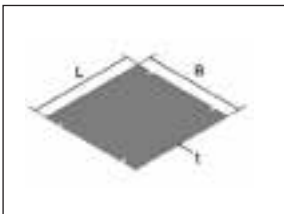
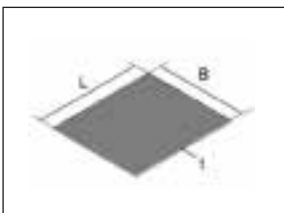

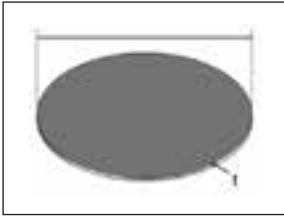
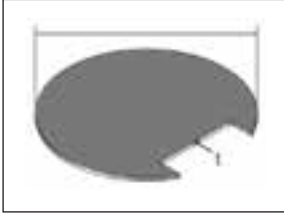
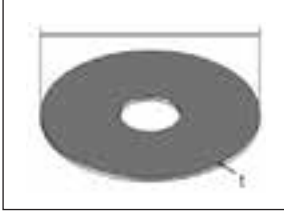
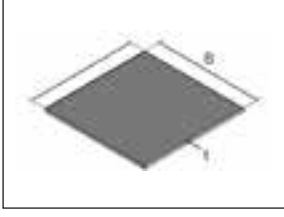
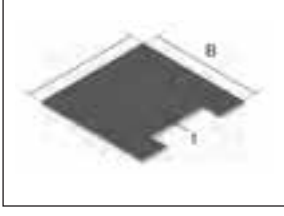

Remplissages pour boîtes de sol

	type	référence	 stock	page. catal.	groupe d'articles	prix en €
Remplissage pour couvercle aveugle, rond, en matière synthétique, triple						
	Carton	2 mm	UEB3-R 2	C08	10402	3,52/pc.
		5 mm	UEB3-R 5	C08	10402	4,15/pc.
	PVC	6 mm	UEB3-R 6K	C08	10402	19,31/pc.
Remplissage pour couvercle à charnière, rond, en matière synthétique, avec brosse, triple						
	Carton	2 mm	UEK3-R 2	C08	10402	3,77/pc.
		5 mm	UEK3-R 5	C08	10402	3,77/pc.
	PVC	6 mm	UEK3-R 6K	C08	10402	16,79/pc.
Remplissage pour couvercle aveugle, carré, en matière synthétique, triple						
	Carton	2 mm	UEB3-V 2	C08	10402	3,45/pc.
		5 mm	UEB3-V 5	C08	10402	3,45/pc.
	PVC	6 mm	UEB3-V 6K	C08	10402	15,23/pc.
Remplissage pour couvercle à charnière, carré, en matière synthétique, avec brosse, triple						
	Carton	2 mm	UEK3-V 2	C09	10402	2,34/pc.
		5 mm	UEK3-V 5	C09	10402	2,34/pc.
	PVC	6 mm	UEK3-V 6K	C09	10402	13,24/pc.
Remplissage pour couvercle aveugle, rond, en matière synthétique, double						
	Carton	3 mm	UEBD2-R 3	C09	10402	3,13/pc.
Remplissage pour couvercle à charnière, rond, en matière synthétique, double						
	Carton	3 mm	UEKD2-R 3	C10	10402	3,39/pc.
Remplissage pour couvercle aveugle, carré, en matière synthétique, double						
	Carton	3 mm	UEBD2-V 3	C10	10402	3,26/pc.
Remplissage pour couvercle à charnière, carré, en matière synthétique, double						
	Carton	3 mm	UEKD2-V 3	C10	10402	1,94/pc.

Remplissages pour boîtes de sol

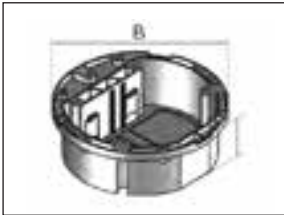
	type	référence	stock	page. catal.	groupe d'articles	prix en €
	Remplissage pour couvercle aveugle triple, rond, en inox					
PVC	6 mm	UEBDE3-R 6		C34	10402	31,01/pc.
	Remplissage pour couvercle avec sortie latérale triple, rond, en inox					
PVC	6 mm	UEKDE3-R 6		C34	10402	33,11/pc.
	Remplissage pour couvercle avec sortie centrale triple, rond, en inox					
PVC	6 mm	UEBDME3-R 6		C34	10402	39,48/pc.
	Remplissage pour couvercle aveugle triple en inox, carré					
PVC	6 mm	UEBDE3-V 6	✓	C34	10402	14,86/pc.
	Remplissage pour couvercle avec sortie latérale triple, rond, en inox					
PVC	6 mm	UEKDE3-V 6		C34	10402	19,29/pc.
	Remplissage pour couvercle avec sortie centrale triple en inox, carré					
PVC	6 mm	UEBDME3-V 6	✓	C35	10402	27,88/pc.

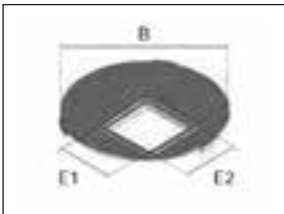
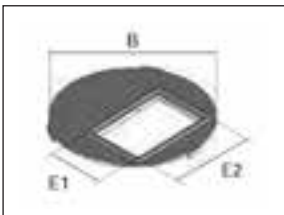
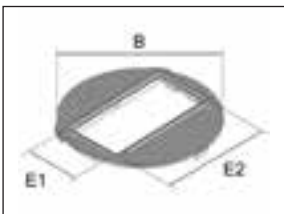
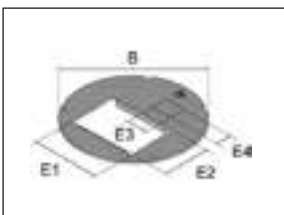

Boîtes d'appareillage et plaques de recouvrement

	type	référence	 stock	page. catal.	groupe d'articles	prix en €
Boîte d'appareillage, ronde						
	ABS	UG-R	UG-R	✓	D04 10406	8,73/pc.
Cloison de séparation						
	ABS	UTG	UTG 75	✓	D04 10406	1,77/pc.
Plaque de recouvrement pour 2 x 45x22,5 mm						
	ABS	UARM	UARM-2-1 118	✓	D04 10406	2,55/pc.
Plaque de recouvrement pour 3 x 45x22,5 mm						
	ABS	UARM	UARM-3-1 118	✓	D04 10406	2,48/pc.
Plaque de recouvrement pour 4 x 45x22,5 mm						
	ABS	UARM	UARM-4-1 118	✓	D04 10406	3,75/pc.
Plaque de recouvrement pour 3 x 45x22,5 mm + 1 x Keystone						
	ABS	UARM	UARM-3-KS1 118S		D05 10406	11,99/pc.
Plaque de recouvrement pour RJ45 et TV						
	Acier	UBE	UBE-AMPSL-TV		D05 10406	13,49/pc.
Plaque de recouvrement pour 2 x RJ45 (Keystone)						
	Acier	UBE	UBE-KS 2		D05 10406	13,49/pc.

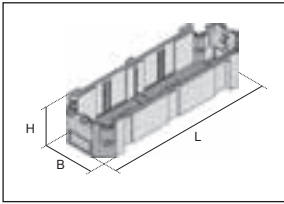
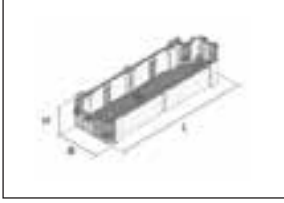
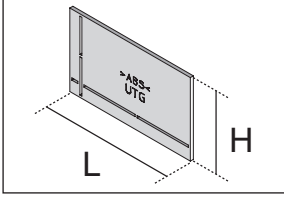
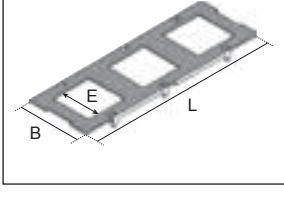
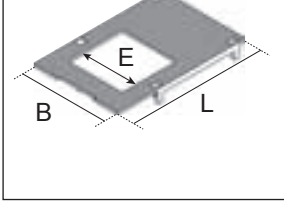
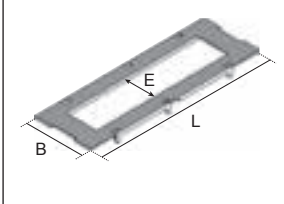
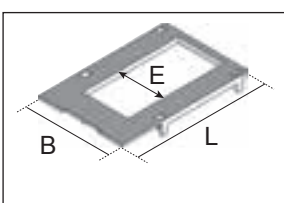
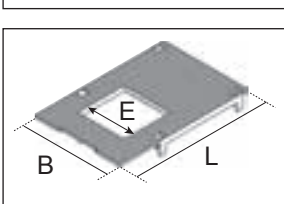
Boîtes d'appareillage et plaques de recouvrement

	type	référence	 stock	page. catal.	groupe d'articles	prix en €
	Boîte d'appareillage, rectangulaire, 46x74x226					
	ABS	UG	✓	D06	10408	5,21/pc.
	Boîte d'appareillage, rectangulaire, 38x74x225					
	ABS	UG3		D06	10408	5,21/pc.
	Cloison de séparation					
	ABS	UTG		D06	10408	1,55/pc.
	Plaque de recouvrement 3x (50x50)					
	ABS	UA	UA-3-1 226	D06	10408	sur demande
	Plaque de recouvrement 1x (50x50)					
	ABS	UA	UA-1-1 113	D07	10408	sur demande
	Plaque de recouvrement 4x (45x45)					
	ABS	UAM	UAM-4-1 226	✓	D07	10408 3,06/pc.
	Plaque de recouvrement 2x (45x45)					
	ABS	UAM	UAM-2-1 113	✓	D07	10408 1,77/pc.
	Plaque de recouvrement 1x (45x45)					
	ABS	UAM	UAM-1-1 113	✓	D07	10408 1,94/pc.

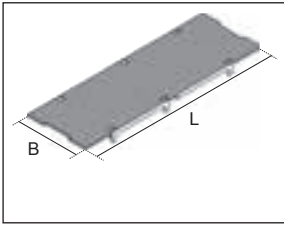
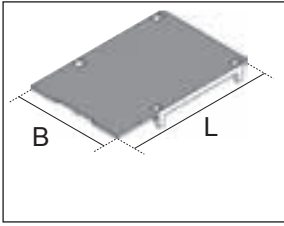
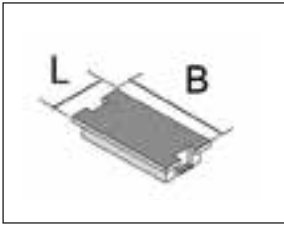
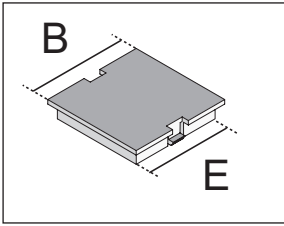
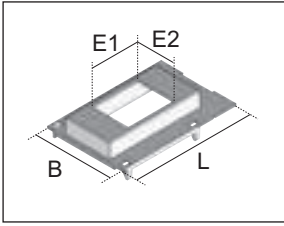
Boîtes d'appareillage et plaques de recouvrement

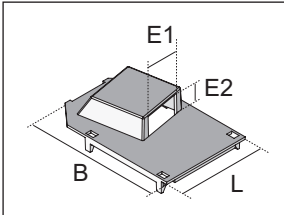
	type	référence	 stock	page. catal.	groupe d'articles	prix en €
Plaque de recouvrement 1x aveugle						
	ABS	UA-B UA-B 226	✓	D12	10408	2,86/pc.
Plaque de recouvrement 1/2x aveugle						
	ABS	UA-B UA-B 113	✓	D12	10408	1,55/pc.
Obturbateur						
	ABS	UAA UAA-B 22	✓	D35	10408	1,44/pc.
Obturbateur						
	ABS	UAA UAA-B 45	✓	D07	10408	1,50/pc.
Plaque de recouvrement pour disjoncteur 2P						
	ABS	UALS UALS-2-1 113		D07	10408	16,62/pc.
Boîte d'appareillage ouverte, rectangulaire						
	ABS	UG45-4	✓	D12	10408	5,99/pc.
Plaque de recouvrement pour connecteur rapide						
	ABS	UAVS UAVS-1-1 113		D12	10408	3,13/pc.







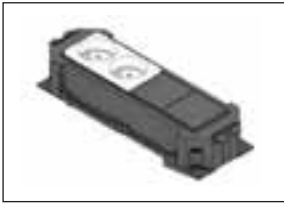

Boîtes d'appareillage et plaques de recouvrement

	type	référence	 stock	page. catal.	groupe d'articles	prix en €
	Technique lumière					
	Acier galvanisé Sendzimir	UGET	UGET-3-SCD 113	D08	10408	20,14/pc.
	Technique lumière					
	Acier galvanisé Sendzimir	UGET	UGET-3-SCS 113	D08	10408	20,14/pc.
	Technique lumière					
	Acier galvanisé Sendzimir	UGET	UGET-2-LCDM 113	D08	10408	18,76/pc.
	Technique de données					
	Acier galvanisé Sendzimir	UGET	UGET-2-BTR 113	D09	10408	18,76/pc.
	Technique de données					
	Acier galvanisé Sendzimir	UGET	UGET-2-COR 113	D09	10408	19,01/pc.
	Technique de données					
	Acier galvanisé Sendzimir	UGET	UGET-2-AMP 113	D09	10408	18,76/pc.
	Technique de données					
	Acier galvanisé Sendzimir	UGET	UGET-2-AMPSL 113	D09	10408	18,76/pc.
	Technique de données					
	Acier galvanisé Sendzimir	UGET	UGET-2-GG45 113	D10	10408	18,76/pc.

Boîtes d'appareillage et plaques de recouvrement

	type	référence	 stock	page. catal.	groupe d'articles	prix en €
						
Technique de données						
Acier galvanisé Sendzimir	UGET	UGET-2-KR 113		D10	10408	18,76/pc.
						
Technique de données						
Acier galvanisé Sendzimir	UGET	UGET-1-RM 113		D10	10408	18,76/pc.
						
Technique de données						
Acier galvanisé Sendzimir	UGET	UGET-2-RMSC 113		D10	10408	18,76/pc.
						
Technique de connexion						
Acier galvanisé Sendzimir	UGET	UGET-1-5PK 113		D10	10408	19,01/pc.
						
Technique de connexion						
Acier galvanisé Sendzimir	UGET	UGET-2-3PK 113		D11	10408	19,80/pc.
						
Technique audio et vidéo						
Acier galvanisé Sendzimir	UGET	UGET-2-KM 113		D08	10408	20,71/pc.
						
Modules 45 x 45 mm						
Acier galvanisé Sendzimir	UGET	UGET-1-UST45 113		D08	10408	21,96/pc.
						
Technique audio et vidéo						
Acier galvanisé Sendzimir	UGET	UGET-2-XLR 113		D09	10408	18,15/pc.
						

Boîtes d'appareillage et plaques de recouvrement

	type	référence	 stock	page. catal.	groupe d'articles	prix en €
	Boîte d'appareillage, prémontée, WAGO					
	2 prises blanches connectées à un connecteur noir	UG45FRWA-W2		D40	10408	48,89/pc.
	Boîte d'appareillage, prémontée, WAGO					
	2 prises rouges connectées à un connecteur blanc	UG45FRWA-R2		D40	10408	51,10/pc.
	Boîte d'appareillage, prémontée, WAGO					
	4 prises blanches connectées à un connecteur noir	UG45FRWA-W4		D40	10408	71,61/pc.
	Boîte d'appareillage, prémontée, WAGO					
	2 prises blanches connectées à un connecteur noir et 2 prises rouges connectées à un connecteur blanc	UG45FRWA-W2R2		D40	10408	81,18/pc.
	Boîte d'appareillage, prémontée Wieland					
	2 prises blanches connectées à un connecteur noir	UG45FRWI-W2	✓	D43	10408	48,89/pc.
	Boîte d'appareillage, prémontée Wieland					
	2 prises rouges connectées à un connecteur blanc	UG45FRWI-R2		D43	10408	51,10/pc.
	Boîte d'appareillage, prémontée Wieland					
	4 prises blanches connectées à un connecteur noir	UG45FRWI-W4	✓	D43	10408	71,61/pc.
	Boîte d'appareillage, prémontée Wieland					
	2 prises blanches connectées à un connecteur noir et 2 prises rouges connectées à un connecteur blanc	UG45FRWI-W2R2		D43	10408	81,18/pc.

Boîtes d'appareillage et plaques de recouvrement

	type	référence	 stock	page. catal.	groupe d'articles	prix en €	
	Supports pour platines (3x UDEP)						
	Acier galvanisé Sendzimir	UGETD	UGETD-3 226	✓	D14	10408	26,65/pc.
			UGETD-UZ		D14	10408	12,98/pc.
	Technique lumière						
	Aluminium	UDEP	UDEP-SCD 4		D15	10408	4,69/pc.
	Technique lumière						
	Aluminium	UDEP	UDEP-SCS 4		D15	10408	4,69/pc.
	Technique de données						
	Aluminium	UDEP	UDEP-BTR 3		D16	10408	4,69/pc.
	Technique de données						
	Aluminium	UDEP	UDEP-COR 3		D16	10408	4,69/pc.
	Technique de données						
	Aluminium	UDEP	UDEP-HAR PL3		D16	10408	4,69/pc.
	Technique de données						
	Aluminium	UDEP	UDEP-AMP 3		D16	10408	4,69/pc.
	Technique de données						
	Aluminium	UDEP	UDEP-AMP SL3		D16	10408	4,69/pc.







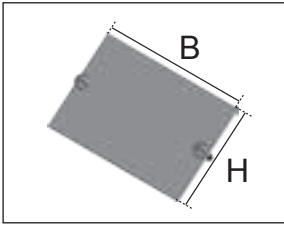

Boîtes d'appareillage et plaques de recouvrement

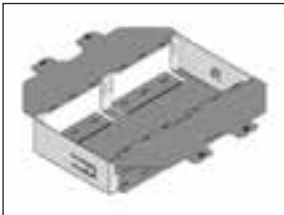
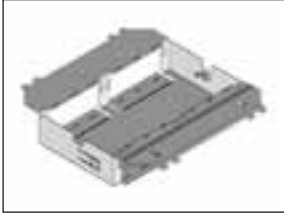
	type	référence	 stock	page. catal.	groupe d'articles	prix en €
	Technique de données					
Aluminium	UDEP	UDEP-GG45 3		D16	10408	4,69/pc.
	Technique de données					
Aluminium	UDEP	UDEP-LEX 2		D18	10408	4,69/pc.
	Technique de données					
Aluminium	UDEP	UDEP-KR 2		D17	10408	4,69/pc.
	Technique de données					
Aluminium	UDEP	UDEP-RM 2		D17	10408	4,69/pc.
	Technique de données					
Aluminium	UDEP	UDEP-RMSC 2		D17	10408	4,69/pc.
	Technique de données					
Aluminium	UDEP	UDEP-RMSC 3		D17	10408	4,69/pc.
	Technique de données					
Aluminium	UDEP	UDEP-KEL 3		D17	10408	11,16/pc.
	Technique de données					
Aluminium	UDEP	UDEP-SYS 2		D17	10408	4,69/pc.

Boîtes d'appareillage et plaques de recouvrement

	type	référence	 stock	page. catal.	groupe d'articles	prix en €
	Platine aveugle					
Aluminium	UDEP	UDEP-B		D14	10408	4,69/pc.
	Technique de connexion					
Aluminium	UDEP	UDEP-5PK 1		D19	10408	4,69/pc.
	Technique de connexion					
Aluminium	UDEP	UDEP-5PCOM 1		D19	10408	4,69/pc.
	Technique de connexion					
Aluminium	UDEP	UDEP-3PK 2		D19	10408	4,69/pc.
	Technique audio et vidéo					
Aluminium	UDEP	UDEP-KM 1		D15	10408	5,35/pc.
	Technique audio et vidéo					
Aluminium	UDEP	UDEP-XLR 2		D15	10408	4,95/pc.
	Technique audio et vidéo					
Aluminium	UDEP	UDEP-DSUB9 1		D15	10408	4,95/pc.

Boîtes d'appareillage et plaques de recouvrement

	type	référence	 stock	page. catal.	groupe d'articles	prix en €
Cadre d'appareillage pour cassette de nivellement ronde						
	Acier galvanisé Sendzimir	UGE	UGE3-RE 4		D27 10408	54,33/pc.
Cadre d'appareillage pour unité de nivellement UNE						
	Acier galvanisé Sendzimir	UGE	UGE3-VE 4		D27 10408	54,33/pc.
Cadre d'appareillage pour boîte de sol en matière synthétique, sortie avec brosse						
	Acier galvanisé Sendzimir	UGE	UGE3-VRK 4		D27 10408	54,33/pc.
Modules 45x45						
	ABS	UGEE	UGEE-2-UST-S		D27 10408	6,28/pc.
Modules 45x45						
	ABS	UGE	UGEE-1-UST-S		D27 10408	6,28/pc.
Pour une platine UDEP						
	ABS	UGE	UGEE-1-DEP-S		D27 10408	6,28/pc.

BODO surélevé et mécanismes

	type	référence	 stock	page. catal.	groupe d'articles	prix en €	
	Base pour BODO surélevé						
	Aluminium	BODO	BODO NA-L	✓	C46	10406	304,50/pc.
	BODO surélevé, vide						
	Aluminium	BODO	BODO NAT-L	✓	C46	10406	386,27/pc.
	Connecteur d'appareil, WAGO						
	Polyamide	UVS	UVS-ST-S1K		D43	10408	4,28/pc.
	Connecteur d'appareil, WIELAND						
	Polyamide	UVSWI	UVSWI-ST-S1		D45	10408	4,16/pc.
	Prise simple, broche de terre						
	Polycarbonate	blanc	UST45FR-W 1	✓	D31	10408	10,04/pc.
		rouge	UST45FR-R 1		D31	10408	11,11/pc.
		ivoire	UST45FR-CW 1		D31	10408	10,04/pc.
	Prise double, broche de terre						
	Polycarbonate	blanc	UST45FR-W 2	✓	D31	10408	17,27/pc.
		rouge	UST45FR-R 2		D31	10408	19,36/pc.
		ivoire	UST45FR-CW 2		D31	10408	17,27/pc.
	Prise triple, broche de terre						
	Polycarbonate	blanc	UST45FR-W 3	✓	D31	10408	27,50/pc.
		rouge	UST45FR-R 3		D31	10408	30,64/pc.
		ivoire	UST45FR-CW 3		D31	10408	27,50/pc.



Gaines murales et canaux d'alimentation

Avec les gaines murales et canaux d'alimentation DUCTEL, le câblage électrique et les câbles de données et de télécommunication sont guidés via le mur vers les différents postes de travail afin d'ainsi pourvoir ces postes de prises de courant et de points de raccordement multimédia rapidement accessibles.

Les canaux d'alimentation DUCTEL ne sont utilisés que pour le passage des câbles alors que les gaines murales DUCTEL offrent la possibilité d'intégrer des prises de courant (traditionnelles ou 45x45 mm).



DUCTEL est disponible en blanc (RAL 9010) laqué ou en version naturelle anodisée et, sur demande, également disponible dans les autres couleurs RAL. La partie arrière est pourvue de perforations. Le système de gaines murales et les couvercles assortis sont toujours livrés avec un feuil de protection.



La pièce d'angle DUCTEL est utilisable comme angle intérieur ou angle extérieur. La pièce d'angle glisse sur la longueur de la gaine et est disponible en blanc et en version anodisée.



Tant les prises traditionnelles que les prises du type de 45 mm peuvent être installées. Ces dernières s'encliquettent directement dans l'ouverture du couvercle, sans outils.



L'embout est fixé sur la gaine par encliquetage sans vis ni outils. Une telle installation simplifiée offre à la fois une économie de coûts, d'effort et de temps.



Le système de gaines murales DUCTEL peut être fixé directement contre la paroi ou par l'intermédiaire de supports muraux. Des parois inégales peuvent être compensées par des pièces ajustables. L'ouverture derrière les gaines murales peut être couverte d'une plaque de couverture.



Des gaines d'alimentation sont utilisées pour le guidage de câbles dans les installations sans prises de courant. Les gaines d'alimentation plus grandes sont idéales pour amener des câbles vers des gaines murales horizontales (page 209-210).







Les nouvelles pièces d'accouplement sont conçues spécialement pour le système DUCTEL et assurent un accouplement parfait de toutes les longueurs.





Le collier DUCTEL facilite le façonnage de dérivations verticales. Montage rapide et peu coûteux.

Gaines murales



Gaines murales DUCTEL pour mécanismes avec anneau de fixation

	TB1010 PK1010	TB1310 PK1310	TB1710	TB2210	TB1032-2
					
Montage	APPARENT				ENCASTRÉ
Dimensions mm	100x65x3000	135x65x3000	170x65x3000	220x65x3000	125/100x65x3000
Nombre de couvercles 80 mm	1	1	1	2	1
Version					
* aluminium anodisé	page 197	page 200	page 203	page 205	/
* aluminium blanc (RAL 9010) laqué	page 197	page 200	page 203	page 205	N page 209
* aluminium noir (RAL 9005) laqué	N page 197	N page 200	N page 203		
* matière synthétique, blanc	N page 198	N page 201	/	/	/







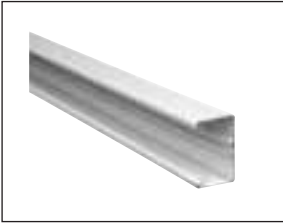
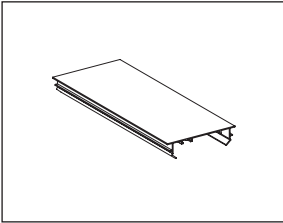
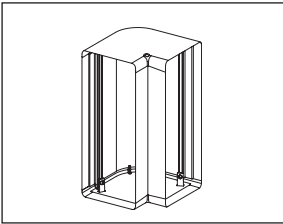
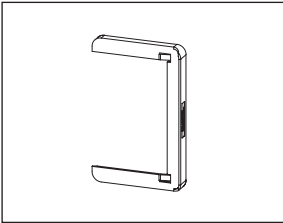
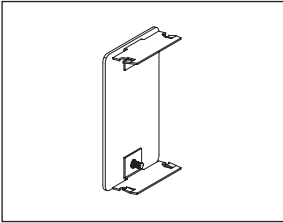
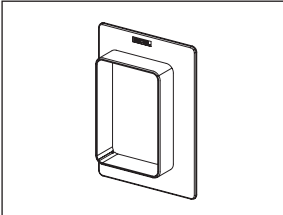

Gaines murales DUCTEL pour modules 45x45

	TB1040	TB1340
		
Montage	APPARENT	
Dimensions mm	100x65x3000	135x65x3000
Nombre de couvercles 45 mm	1	2
Version		
* aluminium anodisé	page 199	page 202
* aluminium blanc (RAL 9010) laqué	page 199	page 202

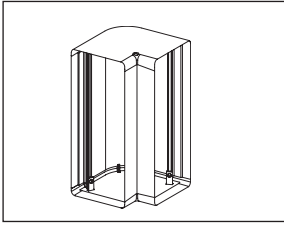
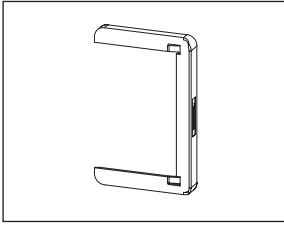

Gaines murales DUCTEL pour modules 45x45 + mécanismes avec anneau de fixation

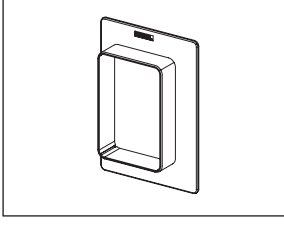



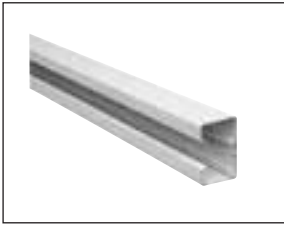
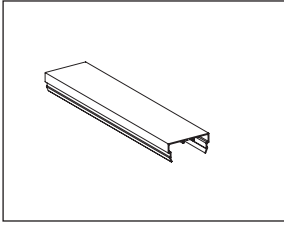
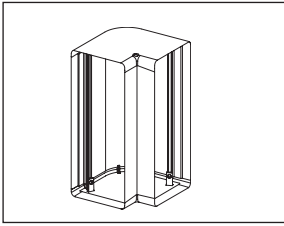
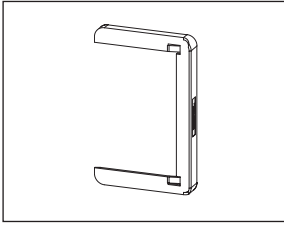
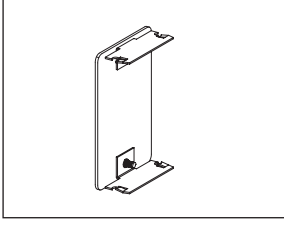
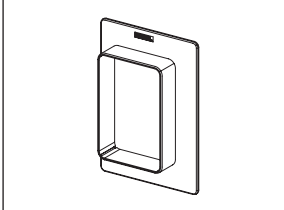

	TB1740	TB2240
		
Montage	APPARENT	
Dimensions mm	170x65x3000	220x65x3000
Nombre de couvercles 45/80 mm	1x45 1x80	2x45 1x80
Version		
* aluminium anodisé	page 204	page 206
* aluminium blanc (RAL 9010) laqué	page 204	page 206
* aluminium noir (RAL 9005) laqué	N page 204	

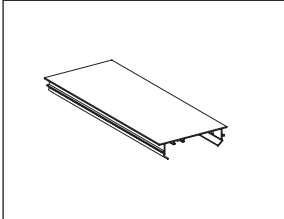
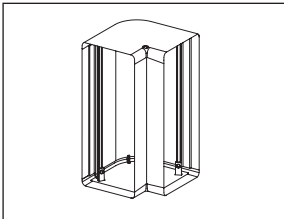
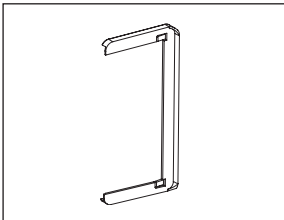
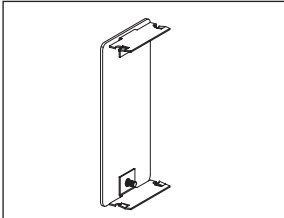
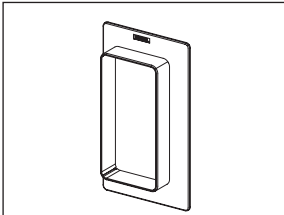
	type	référence	stock	page. catal.	groupe d'articles	prix en €
	Base 100x65					
	Aluminium	anodisé	TB1010-1	✓	8	20601 54,61/m
	↔ 3 m	blanc laqué	TB1010-3	✓	8	20601 54,61/m
		noir laqué	TB1010-2	-	20601	60,08/m
Couvercle à commander séparément.						
	Couvercle 80x19					
	Aluminium	anodisé	TB80-1	✓	8	20601 17,17/m
	↔ 3 m	blanc laqué	TB80-3	✓	8	20601 17,17/m
		noir laqué	TB80-2	-	20601	18,89/m
	Pièce d'angle 103x90x90					
	Aluminium/matière synthétique	anodisé/gris	TBC100-1	✓	8	20601 41,99/pc.
		blanc laqué/blanc	TBC100-3	✓	8	20601 41,99/pc.
		noir laqué	TBC100-2	-	20601	46,20/pc.
	Collier 105x67x12					
	Matière synthétique	gris	TBL10-1	✓	8	20601 8,53/pc.
		blanc	TBL10-3	✓	8	20601 8,53/pc.
	Embout 100x65x24					
	Aluminium	anodisé	TBP100-1	✓	8	20601 13,97/pc.
		blanc laqué	TBP100-3	✓	8	20601 13,97/pc.
		noir laqué	TBP100-2	-	20601	15,37/pc.
	Plaque de finition 151x106x25					
	Matière synthétique	blanc	TB0100-3		8	20601 9,36/pc.

	type	référence	 stock	page. catal.	groupe d'articles	prix en €
	Base 100x65					
	Matière synthétique ↔ 3 m  9 m Couvercle inclus.	blanc	PK1010-3	✓	-	20601
	Couverture					
	Matière synthétique	blanc	PDC100-3	-	-	20601
	Pièce d'angle 103x90x90					
	Aluminium/matière synthétique	blanc laqué/blanc	TBC100-3	✓	9	20601
	Collier 105x67x12					
	Matière synthétique	blanc	TBL10-3	✓	9	20601
	Embout 100x65x24					
	Matière synthétique	blanc	PKE100-3	✓	-	20601
	Plaque de finition 151x106x25					
	Matière synthétique	blanc	TB0100-3	-	9	20601
	Accouplement					
	Matière synthétique	blanc	PKJ1	✓	-	20601

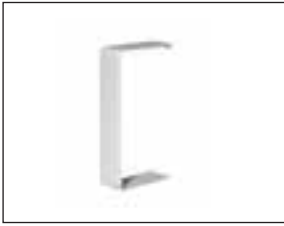
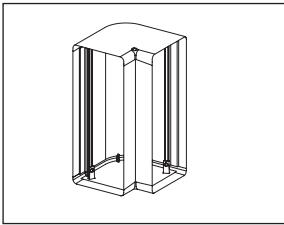
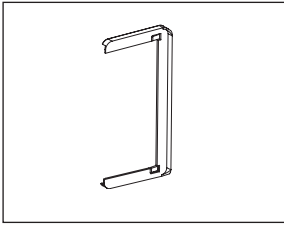
	type	référence	stock	page. catal.	groupe d'articles	prix en €
	Base 100x65					
	Aluminium					
	↔ 3 m	anodisé blanc laqué	TB1040-1 TB1040-3	✓ ✓	9 20601	59,04/m 59,04/m
	Couvercle à commander séparément.					
	Couvercle 45x19					
	Aluminium					
	↔ 3 m	anodisé blanc laqué	TB45-1 TB45-3	✓ ✓	9 20601	12,26/m 12,26/m
	Pièce d'angle 103x90x90					
	Aluminium/matière synthétique					
		anodisé/gris blanc laqué/blanc	TBC100-1 TBC100-3	✓ ✓	9 20601	41,99/pc. 41,99/pc.
	Collier 105x67x12					
	Matière synthétique					
		gris blanc	TBL10-1 TBL10-3	✓ ✓	9 20601	8,53/pc. 8,53/pc.
	Embout 100x65x24					
	Aluminium					
		anodisé blanc laqué	TBP100-1 TBP100-3	✓ ✓	9 20601	13,97/pc. 13,97/pc.
	Plaque de finition 151x106x25					
	Matière synthétique					
		blanc	TB0100-3		9 20601	9,36/pc.

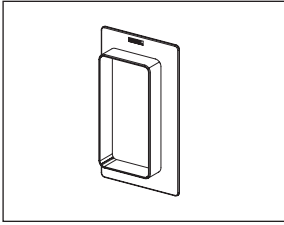
	type	référence	 stock	page. catal.	groupe d'articles	prix en €
	Base 135x65					
	Aluminium					
	↔ 3 m	anodisé	TB1310-1	✓	10	20601 56,39/m
		blanc laqué	TB1310-3	✓	10	20601 56,39/m
		noir laqué		-	20601 62,03/m	
Couvercle à commander séparément.						
	Couvercle 80x19					
	Aluminium					
	↔ 3 m	anodisé	TB80-1	✓	10	20601 17,17/m
		blanc laqué	TB80-3	✓	10	20601 17,17/m
		noir laqué		-	20601 18,89/m	
	Pièce d'angle 138x90x90					
	Aluminium/matière synthétique					
		anodisé/gris	TBC135-1	✓	10	20601 41,99/pc.
		blanc laqué/blanc	TBC135-3	✓	10	20601 41,99/pc.
		noir laqué		-	20601 46,20/pc.	
	Collier 140x67x12					
	Matière synthétique					
		gris	TBL13-1	✓	10	20601 8,53/pc.
		blanc	TBL13-3	✓	10	20601 8,53/pc.
	Embout 135x65x24					
	Aluminium					
		anodisé	TBP135-1	✓	10	20601 14,98/pc.
		blanc laqué	TBP135-3	✓	10	20601 14,98/pc.
		noir laqué		-	20601 16,48/pc.	
	Plaque de finition 186x106x25					
	Matière synthétique	blanc	TB0135-3	✓	10	20601 9,95/pc.

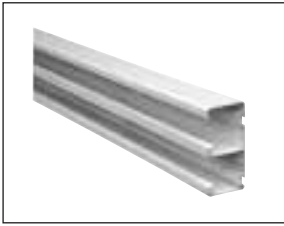
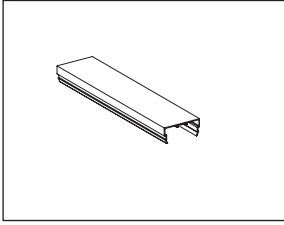
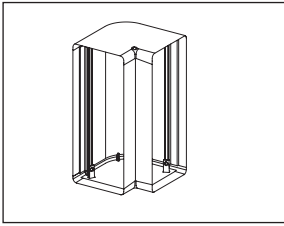
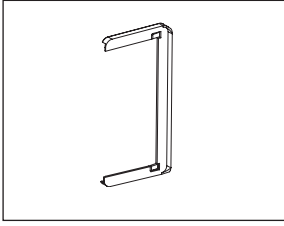
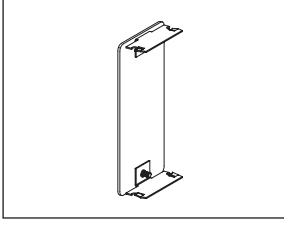
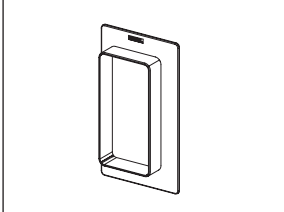

	type	référence	stock	page. catal.	groupe d'articles	prix en €
	Base 135x65					
	Matière synthétique ↔ 3 m  9 m Couverture inclus.	blanc	PK1310-3	-	20601	34,86/m
	Couverture					
	Matière synthétique	blanc	PDC135-3	-	20601	5,17/pc.
	Pièce d'angle 138x90x90					
	Aluminium/matière synthétique	blanc laqué/blanc	TBC135-3	✓	10	20601 41,99/pc.
	Collier 140x67x12					
	Matière synthétique	blanc	TBL13-3	✓	10	20601 8,53/pc.
	Embout 135x65x24					
	Matière synthétique	blanc	PKE135-3	-	20601	5,87/pc.
	Plaque de finition 186x106x25					
	Matière synthétique	blanc	TB0135-3	✓	10	20601 9,95/pc.
	Accouplement					
	Matière synthétique	blanc	PKJ1	✓	-	20601 1,94/pc.

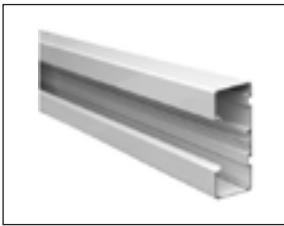
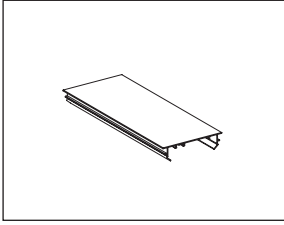
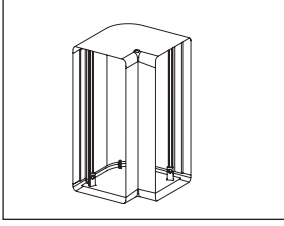
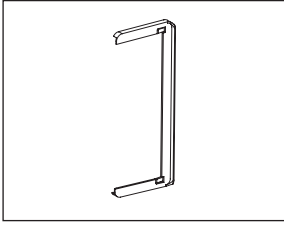
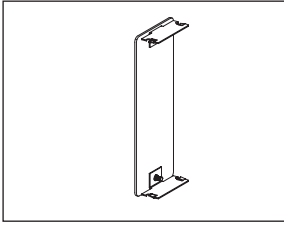
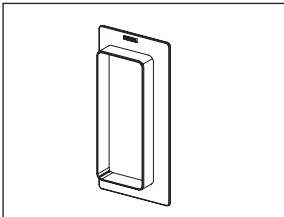
	type	référence	 stock	page. catal.	groupe d'articles	prix en €
	Base 135x65					
	Aluminium					
	↔ 3 m	anodisé blanc laqué	TB1340-1 TB1340-3	✓ ✓	11 11	20601 20601
	Couvercle à commander séparément.					
	Couvercle 45x19					
	Aluminium					
		anodisé blanc laqué	TB45-1 TB45-3	✓ ✓	11 11	20601 20601
	Pièce d'angle 138x90x90					
	Aluminium/matière synthétique					
		anodisé/gris blanc laqué/blanc	TBC135-1 TBC135-3	✓ ✓	11 11	20601 20601
	Collier 140x67x12					
	Matière synthétique					
		gris blanc	TBL13-1 TBL13-3	✓ ✓	11 11	20601 20601
	Embout 135x65x24					
	Aluminium					
		anodisé blanc laqué	TBP135-1 TBP135-3	✓ ✓	11 11	20601 20601
	Plaque de finition 186x106x25					
	Matière synthétique					
		blanc	TB0135-3	✓	11	20601



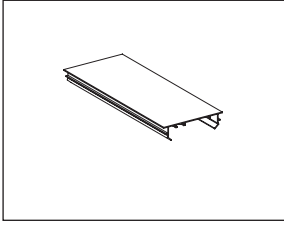
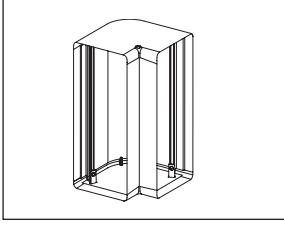
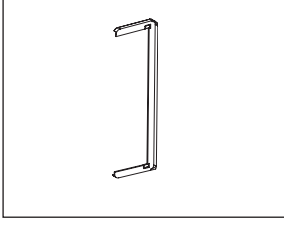
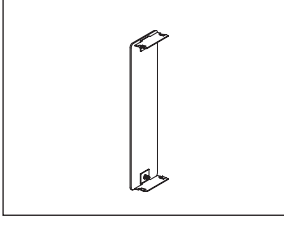
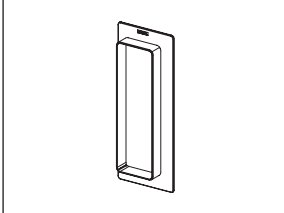



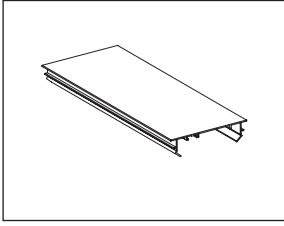
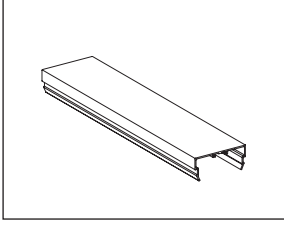
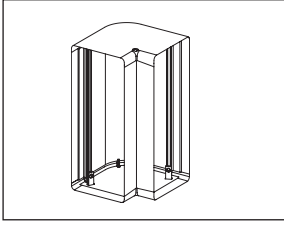
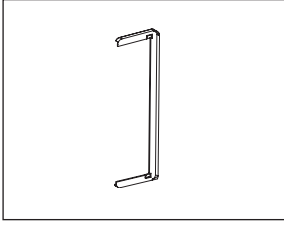
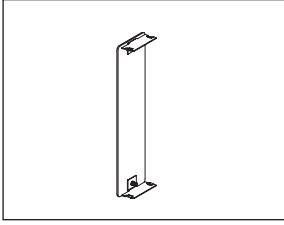
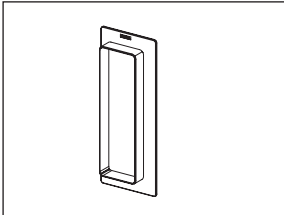

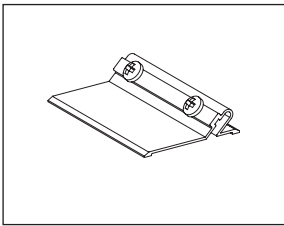

	type	référence	stock	page. catal.	groupe d'articles	prix en €
	Base 170x65					
	Aluminium	anodisé	TB1710-1	✓	12	20601 71,48/m
	↔ 3 m	blanc laqué	TB1710-3	✓	12	20601 71,48/m
		noir laqué	TB1710-2	-	20601	78,63/m
Couvercle à commander séparément.						
	Couvercle 80x19					
	Aluminium	anodisé	TB80-1	✓	12	20601 17,17/m
	↔ 3 m	blanc laqué	TB80-3	✓	12	20601 17,17/m
		noir laqué	TB80-2	-	20601	18,89/m
	Pièce d'angle 173x90x90					
	Aluminium/matière synthétique	anodisé/gris	TBC170-1	✓	12	20601 44,53/pc.
		blanc laqué/blanc	TBC170-3	✓	12	20601 44,53/pc.
		noir laqué	TBC170-2	-	20601	48,98/pc.
	Collier 175x67x12					
	Matière synthétique	gris	TBL17-1	✓	12	20601 8,53/pc.
		blanc	TBL17-3	✓	12	20601 8,53/pc.
	Embout 170x65x24					
	Aluminium	anodisé	TBP170-1	✓	12	20601 16,94/pc.
		blanc laqué	TBP170-3	✓	12	20601 16,94/pc.
		noir laqué	TBP170-2	-	20601	18,64/pc.
	Plaque de finition 221x106x25					
	Matière synthétique	blanc	TB0170-3	✓	12	20601 10,25/pc.

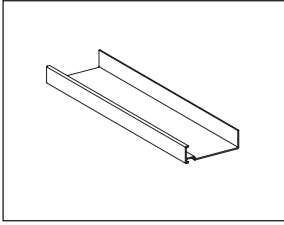
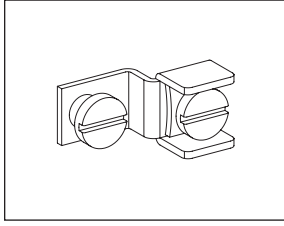
	type	référence	 stock	page. catal.	groupe d'articles	prix en €
	Base 170x65					
	Aluminium					
	↔ 3 m	anodisé blanc laqué noir laqué	TB1740-1 TB1740-3 TB1740-2	✓ ✓ -	13 13 20601	72,91/m 72,91/m 80,21/m
	Couvercle à commander séparément.					
	Couvercle 80x19					
	Aluminium					
	↔ 3 m	anodisé blanc laqué noir laqué	TB80-1 TB80-3 TB80-2	✓ ✓ -	13 13 20601	17,17/m 17,17/m 18,89/m
	Couvercle 45x19					
	Aluminium					
	↔ 3 m	anodisé blanc laqué noir laqué	TB45-1 TB45-3 TB45-2	✓ ✓ -	13 13 20601	12,26/m 12,26/m 13,48/m
	Pièce d'angle 173x90x90					
	Aluminium/matière synthétique					
		anodisé/gris blanc laqué/blanc noir laqué	TBC170-1 TBC170-3 TBC170-2	✓ ✓ -	13 13 20601	44,53/pc. 44,53/pc. 48,98/pc.
	Collier 175x67x12					
	Matière synthétique					
		gris blanc	TBL17-1 TBL17-3	✓ ✓	13 13	8,53/pc. 8,53/pc.
	Embout 170x65x24					
	Aluminium					
		anodisé blanc laqué noir laqué	TBP170-1 TBP170-3 TBP170-2	✓ ✓ -	13 13 20601	16,94/pc. 16,94/pc. 18,64/pc.
	Plaque de finition 221x106x25					
	Matière synthétique	blanc	TB0170-3	✓	13	20601 10,25/pc.

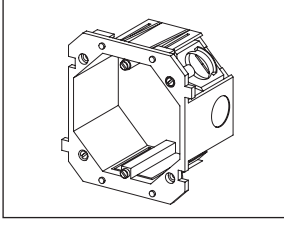

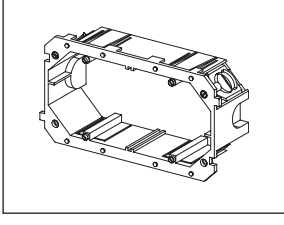

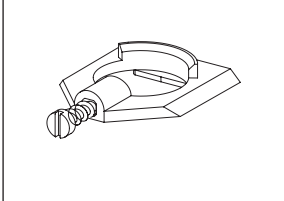





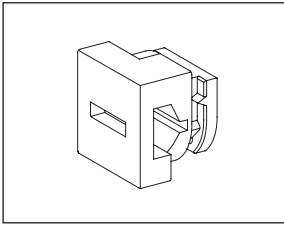

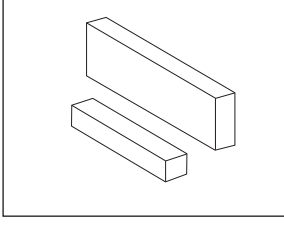
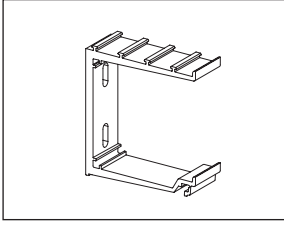
	type	référence	stock	page. catal.	groupe d'articles	prix en €
	Base 220x65					
	Aluminium					
	↔ 3 m	anodisé	TB2210-1	✓	14	20601 96,42/m
		blanc laqué	TB2210-3	✓	14	20601 96,42/m
Couvercle à commander séparément.						
	Couvercle 80x19					
	Aluminium					
	↔ 3 m	anodisé	TB80-1	✓	14	20601 17,17/m
		blanc laqué	TB80-3	✓	14	20601 17,17/m
	Pièce d'angle 223x90x90					
	Aluminium/matière synthétique					
		anodisé/gris	TBC220-1		14	20601 47,19/pc.
		blanc laqué/blanc	TBC220-3		14	20601 47,19/pc.
	Collier 225x67x12					
	Matière synthétique					
		gris	TBL22-1		14	20601 8,53/pc.
		blanc	TBL22-3		14	20601 8,53/pc.
	Embout 220x65x24					
	Aluminium					
		anodisé	TBP220-1	✓	14	20601 18,66/pc.
		blanc laqué	TBP220-3		14	20601 18,66/pc.
	Plaque de finition 271x106x25					
	Matière synthétique					
		blanc	TB0220-3		14	20601 10,67/pc.

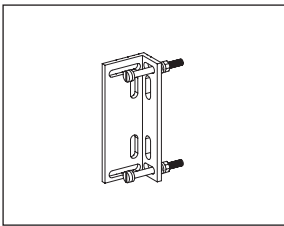
	type	référence	 stock	page. catal.	groupe d'articles	prix en €
	Base 220x65					
	Aluminium					
	↔ 3 m	anodisé blanc laqué		-	20601	119,98/m
				-	20601	119,98/m
Couvercle à commander séparément.						
	Couvercle 80x19					
	Aluminium					
	↔ 3 m	anodisé blanc laqué	✓	14	20601	17,17/m
			✓	14	20601	17,17/m
	Couvercle 45x19					
	Aluminium					
	↔ 3 m	anodisé blanc laqué	✓	14	20601	12,26/m
			✓	14	20601	12,26/m
	Pièce d'angle 223x90x90					
	Aluminium/matière synthétique					
		anodisé/gris		14	20601	47,19/pc.
		blanc laqué/blanc		14	20601	47,19/pc.
	Collier 225x67x12					
	Matière synthétique					
		gris		14	20601	8,53/pc.
		blanc		14	20601	8,53/pc.
	Embout 220x65x24					
	Aluminium					
		anodisé	✓	14	20601	18,66/pc.
		blanc laqué		14	20601	18,66/pc.
	Plaque de finition 271x106x25					
	Matière synthétique					
		blanc		14	20601	10,67/pc.

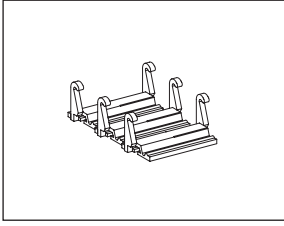
Systeme de gaines murales Ductel

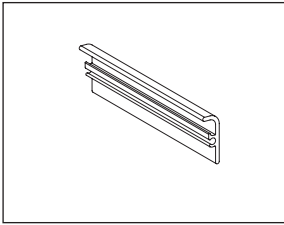
	type	référence	stock	page. catal.	groupe d'articles	prix en €
	Accouplement 12x53x70 Aluminium  20 pc.	TBJ1	✓	15	20601	4,86/pc.
	Uniquement pour gaines murales en aluminium.					
	Cloison de séparation 15x52 Aluminium ↔ 1 m	TDH1	✓	15	20601	11,84/m
	Borne de mise à la terre Acier  20 pc.	TBM1	✓	16	20601	7,39/pc.
	Boîte d'encastrement 79x42,5x79 Matière synthétique bleu  10 pc.	TBF1	✓	17	20601	6,40/pc.
	Boîte d'encastrement 79x42,5x150 Matière synthétique bleu  5 pc.	TBF2	✓	17	20601	14,51/pc.
	Serre-câbles Matière synthétique noir  20 pc.	TBF11		17	20601	1,48/pc.

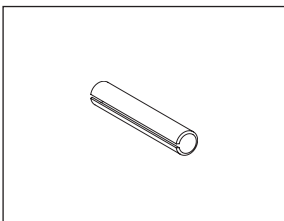
Systeme de gaines murales Ductel

	type	référence	 stock	page. catal.	groupe d'articles	prix en €
	Clame de fixation					
	Matière synthétique  100 pc.	TBK1		16	20601	0,57/pc.
	Bande d'isolation					
	Matière synthétique	32x30x300	XTB0304	16	20601	9,72/pc.
		74x30x300	XTB0308	16	20601	16,71/pc.
	Etrier mural					
	Aluminium					
	 20 pc.	25	TBE25	15	20601	6,93/pc.
		50	TBE50	15	20601	8,29/pc.
		75	TBE75	15	20601	10,67/pc.
		100	TBE100	15	20601	13,19/pc.
		125	TBE125	15	20601	16,06/pc.
	Plaque d'ajustage					
	Aluminium  20 pc.		TBE1	15	20601	10,54/pc.
	Clip de fixation pour ailettes de ventilation 73x40					
	Matière synthétique  20 pc.		TBE3	16	20601	3,43/pc.
	Ailettes de ventilation 24x9					
	Aluminium					
		anodisé	TBE20-1	17	20601	11,56/m
	 3 m  90 m	blanc laqué	TBE20-3	17	20601	11,56/m
	Accouplement 3x18					
	Acier  10 pc.		TBJ8	17	20601	0,52/pc.

Gaine murale encastrée et canaux d'alimentation Ductel

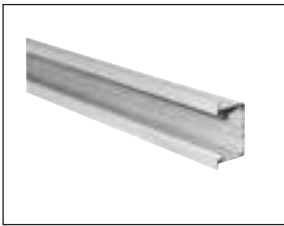
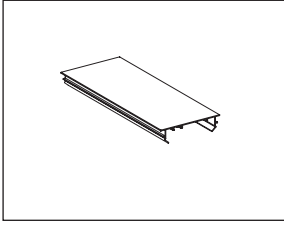
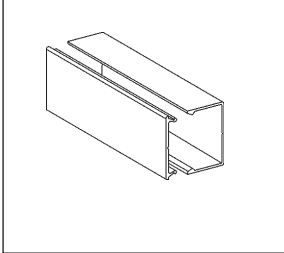
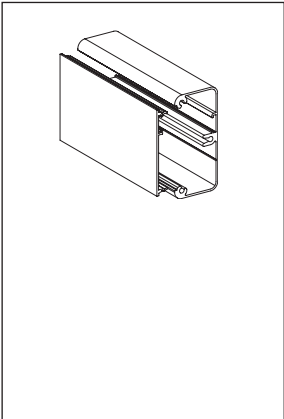
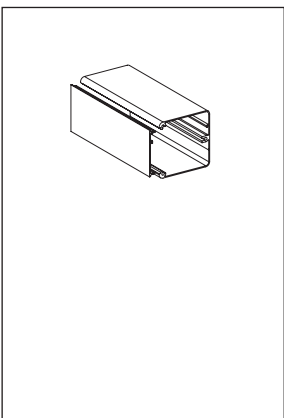
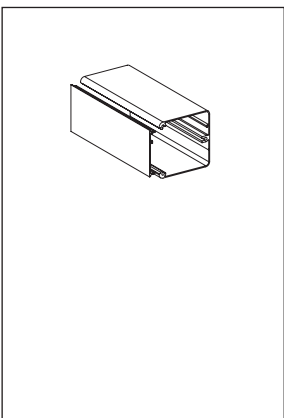
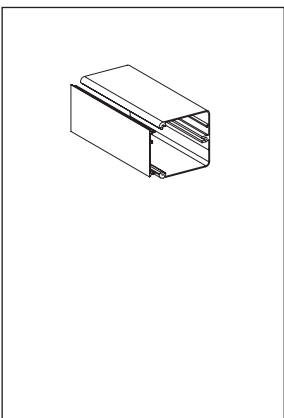
	type	référence	stock	page. catal.	groupe d'articles	prix en €
	Base 125/100x65					
	Aluminium ↔ 3 m	blanc laqué TB1032-3	✓	-	20601	62,29/m
	Couvercle à commander séparément.					
	Couvercle 80x19					
	Aluminium ↔ 3 m	blanc laqué TB80-3	✓	-	20601	17,17/m
	Base 30x20,5					
	Aluminium ↔ 3 m	anodisé blanc laqué	✓	-	20602	17,53/m
		TBA202-3	✓	-	20602	17,53/m
	Couvercle 32x6					
	Aluminium ↔ 3 m	anodisé blanc laqué	✓	-	20602	11,84/m
		TBA22-3	✓	-	20602	11,84/m
	Base 65x30					
	Aluminium ↔ 3 m	anodisé blanc laqué	✓	21	20602	33,05/m
		TBA302-3	✓	21	20602	33,05/m
	Couvercle 54x7,5					
	Aluminium ↔ 3 m	anodisé blanc laqué	✓	21	20602	12,44/m
		TBA32-3	✓	21	20602	12,44/m
	Embout 65x30					
	Aluminium	anodisé blanc laqué	✓	21	20602	10,72/pc.
		TBD30-3	✓	21	20602	10,72/pc.
	Base 65x65					
	Aluminium ↔ 3 m	anodisé blanc laqué		21	20602	43,29/m
		TBA652-3		21	20602	43,29/m
	Couvercle 54x7,5					
	Aluminium ↔ 3 m	anodisé blanc laqué	✓	21	20602	12,44/m
		TBA32-3	✓	21	20602	12,44/m
	Embout 65x65					
	Aluminium	anodisé blanc laqué		21	20602	10,84/pc.
		TBD65-3		21	20602	10,84/pc.

Gaines d'alimentation Ductel

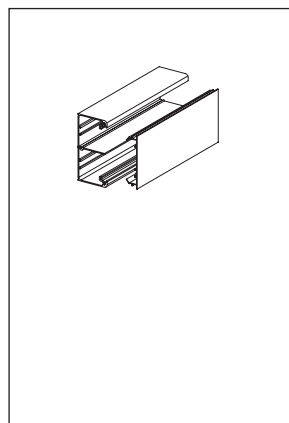

Base 100x49

Aluminium	type	référence	stock	page. catal.	groupe d'articles	prix en €
↔ 3 m	anodisé	TBA10-1		21	20602	60,99/m
	blanc laqué	TBA10-3		21	20602	60,99/m

Couvercle 80x19

↔ 3 m	anodisé	TB80-1	✓	21	20601	17,17/m
	blanc laqué	TB80-3	✓	21	20601	17,17/m

Embout 100x49

Aluminium	anodisé	TBD100-1		21	20602	12,08/pc.
	blanc laqué	TBD100-3		21	20602	12,08/pc.

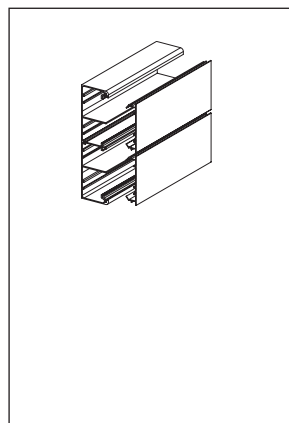

Base 184x49

↔ 3 m	anodisé	TBA18-1		21	20602	107,49/m
	blanc laqué	TBA18-3		21	20602	107,49/m

Couvercle 80x19

↔ 3 m	anodisé	TB80-1	✓	21	20601	17,17/m
	blanc laqué	TB80-3	✓	21	20601	17,17/m

Embout 184x49

Aluminium	anodisé	TBD180-1		21	20602	13,69/pc.
	blanc laqué	TBD180-3		21	20602	13,69/pc.



Canalisations à câbles en matière synthétique

Les gaines murales et canaux d'alimentation en matière synthétique conduisent le câblage de courant, de données et de télécommunication via la paroi vers les différents endroits afin de les pourvoir simplement de prises de courant et de points de connexion multimédia à accès aisé.

Canaux d'alimentation



avec encoche
page 232



avec couvercle à charnière
page 230



anguleux
page 233-236



élégant
sur demande



canal d'alimentation
page 236-237

Canaux de sol – Canaux de coin – Canaux de plinthe



canal de sol arrondi
page 231



canal de coin
triangulaire page 230

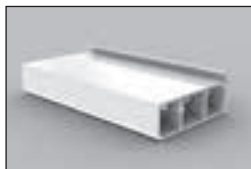

canal de plinthe
page 228



canal de plinthe
page 227

Gainés murales



pour montage à
anneau standard
page 216-219



pour modules 45 x 45
page 213-215

Goulottes de câblage



goulotte de câblage
page 238



Canalisations à câbles en matière synthétique exemptes d'halogènes

La version des gaines murales et canaux d'alimentation exempts d'halogènes est requise dans les bâtiments publics comme les hôpitaux, les écoles, les musées, les centres d'aide sociale, ...

Grâce à leur composition chimique spécifique, les gaines à câbles exemptes d'halogènes KOPOS émettent, en cas d'incendie, moins de gaz nuisibles, qui – en combinaison avec des produits extincteurs – peuvent produire des gaz toxiques. Donc, en cas d'incendie, la sécurité des personnes encore présentes dans le bâtiment et des services d'urgence est considérablement augmentée. Ainsi, les blessures corporelles et les dommages peuvent être limités au minimum.

Canaux d'alimentation type LHD – exempts d'halogènes



LHD20x10HF
page 233



LHD20x20HF
page 234



LHD40x20HF
page 235



LHD40x40HF
page 236



EKD80x40HF
page 237

Canal d'alimentation EKD exempt d'halogènes

Gainés murales – exemptes d'halogènes



PK110x70DHF
pour montage à
anneau standard
page 217



















PK90x55DHF
pour modules 45 x 45
page 213

Goulottes de câblage – exemptes d'halogènes



















RK...X...HF
page 238

















Systemes de gaines murales PK

	type	référence	stock	page. catal.	groupe d'articles	prix en €	
	Base + couvercle PK 90x55 D						
	Matière synthétique	blanc	KPK90X55DHD	✓	43	20501	16,84/m
	Matière synthétique exempte d'halogènes	blanc	KPK90X55DHFHD	✓	55	20501	45,47/m
	↔ 2 m  12 m						
	Embout PK 90x55 D						
	Matière synthétique	blanc	K8401HB	✓	43	20506	7,77/pc.
	Matière synthétique exempte d'halogènes	blanc	K8401HFHB	✓	55	20506	10,87/pc.
	 2 pc.						
	Accouplement PK 90x55 D						
	Matière synthétique	blanc	K8402HB	✓	43	20506	7,77/pc.
	Matière synthétique exempte d'halogènes	blanc	K8402HFHB	✓	55	20506	10,87/pc.
	 2 pc.						
	Angle plat PK 90x55 D						
	Matière synthétique	blanc	K8403HB	✓	43	20506	15,50/pc.
	Matière synthétique exempte d'halogènes	blanc	K8403HFHB	✓	55	20506	19,12/pc.
	 2 pc.						
	Pièce en T PK 90x55 D						
	Matière synthétique	blanc	K8404HB	✓	43	20506	15,50/pc.
	Matière synthétique exempte d'halogènes	blanc	K8404HFHB	✓	55	20506	19,12/pc.
	 2 pc.						
	Angle intérieur PK 90x55 D						
	Matière synthétique	blanc	K8405HB	✓	43	20506	15,50/pc.
	Matière synthétique exempte d'halogènes	blanc	K8405HFHB	✓	55	20506	19,12/pc.
	 2 pc.						
	Angle extérieur PK 90x55 D						
	Matière synthétique	blanc	K8406HB	✓	43	20506	15,50/pc.
	Matière synthétique exempte d'halogènes	blanc	K8406HFHB	✓	55	20506	19,12/pc.
	 2 pc.						
	Plaque de finition PK 90x55 D						
	Matière synthétique	blanc	K8407HB	✓	43	20506	6,11/pc.
	Matière synthétique exempte d'halogènes	blanc	K8407HFHB	✓	55	20506	10,87/pc.
	 2 pc.						

















Systemes de gaines murales PK

	type	référence	 stock	page. catal.	groupe d'articles	prix en €
	Base + couvercle PK 120x55 D					
	Matière synthétique	blanc		44	20501	29,12/m
	↔ 2 m  6 m	KPK120X55DHD				
	Embout PK 120x55 D					
	Matière synthétique	blanc		44	20506	12,08/pc.
	 2 pc.	K8471HB				
	Accouplement PK 120x55 D					
	Matière synthétique	blanc		44	20506	12,08/pc.
	 2 pc.	K8472HB				
	Angle plat PK 120x55 D					
	Matière synthétique	blanc		44	20506	21,27/pc.
	 2 pc.	K8473HB				
	Pièce en T PK 120x55 D					
	Matière synthétique	blanc		44	20506	21,27/pc.
	 2 pc.	K8474HB				
	Angle intérieur PK 120x55 D					
	Matière synthétique	blanc		44	20506	21,27/pc.
	 2 pc.	K8475HB				
	Angle extérieur PK 120x55 D					
	Matière synthétique	blanc		44	20506	21,27/pc.
	 2 pc.	K8476HB				
	Plaque de finition PK 120x55 D					
	Matière synthétique	blanc		44	20506	8,46/pc.
	 2 pc.	K8477HB				

















Systemes de gaines murales PK

	type	réf�rence	stock	page. catal.	groupe d'articles	prix en �
	Base + couvercle PK 160x65 D					
	Mati�re synth�tique	blanc	KPK160X65DHD	✓	45	20501
	↔ 2 m	 6 m				
	Embout PK 160x65 D					
	Mati�re synth�tique	blanc	K8481HB	✓	45	20506
	 2 pc.					
	Accouplement PK 160x65 D					
	Mati�re synth�tique	blanc	K8482HB	✓	45	20506
	 2 pc.					
	Angle plat PK 160x65 D					
	Mati�re synth�tique	blanc	K8483HB	✓	45	20506
	 2 pc.					
	Pi�ce en T PK 160x65 D					
	Mati�re synth�tique	blanc	K8484HB	✓	45	20506
	 2 pc.					
	Angle int�rieur PK 160x65 D					
	Mati�re synth�tique	blanc	K8485HB	✓	45	20506
	 2 pc.					
	Angle ext�rieur PK 160x65 D					
	Mati�re synth�tique	blanc	K8486HB	✓	45	20506
	 2 pc.					
	Plaque de finition PK 160x65 D					
	Mati�re synth�tique	blanc	K8487HB	✓	45	20506
	 2 pc.					













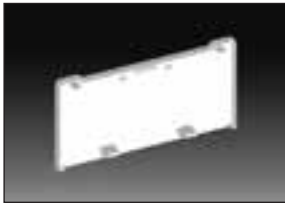



Systemes de gaines murales PK

	type	référence	 stock	page. catal.	groupe d'articles	prix en €
						
Base + couvercle PK 210x70 D						
Matière synthétique	blanc	KPK210X70DHD		46	20501	51,94/m
↔ 2 m  6 m						
						
Embout PK 210x70 D						
Matière synthétique	blanc	K8491HB		46	20506	17,91/pc.
 2 pc.						
						
Accouplement PK 210x70 D						
Matière synthétique	blanc	K8492HB		46	20506	18,14/pc.
 2 pc.						
						
Angle plat PK 210x70 D						
Matière synthétique	blanc	K8493HB		46	20506	28,53/pc.
 2 pc.						
						
Pièce en T PK 210x70 D						
Matière synthétique	blanc	K8494HB		46	20506	28,53/pc.
 2 pc.						
						
Angle intérieur PK 210x70 D						
Matière synthétique	blanc	K8495HB		46	20506	28,53/pc.
 2 pc.						
						
Angle extérieur PK 210x70 D						
Matière synthétique	blanc	K8496HB		46	20506	28,53/pc.
 2 pc.						
						
Plaque de finition PK 210x70 D						
Matière synthétique	blanc	K8497HB		46	20506	12,82/pc.
 2 pc.						













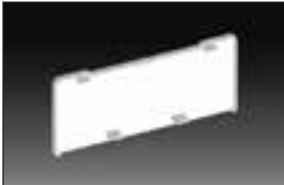

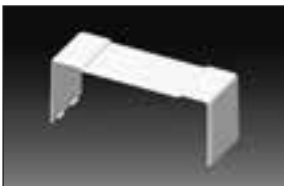

Systemes de gaines murales PK

	type	référence	stock	page. catal.	groupe d'articles	prix en €	
	Base + couvercle PK 110x70 D						
	Matière synthétique exempte d'halogènes	blanc	KPK110X70DHFHD	✓	54	20501	67,01/m
	↔ 2 m  6 m						
	Embout PK 110x70 D						
	Matière synthétique exempte d'halogènes	blanc	K8451HFHB	✓	54	20506	12,94/pc.
	 2 pc.						
	Accouplement PK 110x70 D						
	Matière synthétique exempte d'halogènes	blanc	K8452HFHB	✓	54	20506	12,34/pc.
	 2 pc.						
	Angle plat PK 110x70 D						
	Matière synthétique exempte d'halogènes	blanc	K8453HFHB	✓	54	20506	18,82/pc.
	 2 pc.						
	Pièce en T PK 110x70 D						
	Matière synthétique exempte d'halogènes	blanc	K8454HFHB	✓	54	20506	18,82/pc.
	 2 pc.						
	Angle intérieur PK 110x70 D						
	Matière synthétique exempte d'halogènes	blanc	K8455HFHB	✓	54	20506	19,89/pc.
	 2 pc.						
	Angle extérieur PK 110x70 D						
	Matière synthétique exempte d'halogènes	blanc	K8456HFHB	✓	54	20506	18,82/pc.
	 2 pc.						
	Plaque de finition PK 110x70 D						
	Matière synthétique exempte d'halogènes	blanc	K8457HFHB	✓	54	20506	7,51/pc.
	 2 pc.						

















Systemes de gaines murales PK

	type	référence	 stock	page. catal.	groupe d'articles	prix en €
	Base + couvercle PK 140x70 D					
Matière synthétique	blanc	KPK140X70DHD		41	20501	29,94/m
↔ 2 m  6 m						
	Embout PK 140x70 D					
Matière synthétique	blanc	K8461HB		41	20506	12,33/pc.
 2 pc.						
	Accouplement PK 140x70 D					
Matière synthétique	blanc	K8462HB		41	20506	12,33/pc.
 2 pc.						
	Angle plat PK 140x70 D					
Matière synthétique	blanc	K8463HB		41	20506	19,82/pc.
 2 pc.						
	Pièce en T PK 140x70 D					
Matière synthétique	blanc	K8464HB		41	20506	19,82/pc.
 2 pc.						
	Angle intérieur PK 140x70 D					
Matière synthétique	blanc	K8465HB		41	20506	19,82/pc.
 2 pc.						
	Angle extérieur PK 140x70 D					
Matière synthétique	blanc	K8466HB		41	20506	19,82/pc.
 2 pc.						
	Plaque de finition PK 140x70 D					
Matière synthétique	blanc	K8467HB		41	20506	7,02/pc.
 2 pc.						













Systemes de gaines murales PK

	type	référence	 stock	page. catal.	groupe d'articles	prix en €
						
Base + couvercle PK 170x70 D						
Matière synthétique	blanc	KPK170X70DHD		42	20501	36,32/m
↔ 2 m  6 m						
						
Embout PK 170x70 D						
Matière synthétique	blanc	K8441HB		42	20506	16,45/pc.
 2 pc.						
						
Accouplement PK 170x70 D						
Matière synthétique	blanc	K8442HB		42	20506	16,45/pc.
 2 pc.						
						
Angle plat PK 170x70 D						
Matière synthétique	blanc	K8443HB		42	20506	21,57/pc.
 2 pc.						
						
Pièce en T PK 170x70 D						
Matière synthétique	blanc	K8444HB		42	20506	21,57/pc.
 2 pc.						
						
Angle intérieur PK 170x70 D						
Matière synthétique	blanc	K8445HB		42	20506	21,57/pc.
 2 pc.						
						
Angle extérieur PK 170x70 D						
Matière synthétique	blanc	K8446HB		42	20506	21,57/pc.
 2 pc.						
						
Plaque de finition PK 170x70 D						
Matière synthétique	blanc	K8447HB		42	20506	9,39/pc.
 2 pc.						















Systemes de gaines murales PK

	type	référence	 stock	page. catal.	groupe d'articles	prix en €
	Cloison de séparation H= 45 mm					
	Matière synthétique					
	blanc	KPEKE60C	✓	57	20501	6,52/m
	↔ 2 m  20 m					
	Cloison de séparation H= 45 mm					
	Matière synthétique avec feuil métallique	KPKS70/60		57	20501	10,62/m
	↔ 2 m  20 m					
	Cloison de séparation H= 29,5 mm					
	Matière synthétique	blanc		57	20503	3,02/m
	Matière synthétique exempte d'halogènes	blanc	✓	56	20503	7,74/m
	↔ 2 m  20 m					
	Cloison de séparation H= 42,5 mm					
	Matière synthétique	blanc		58	20501	12,88/m
	↔ 2 m  32 m	KPEP60HD				
	Cloison de séparation H= 42,5 mm					
	Acier			58	20501	30,21/m
	↔ 2 m  24 m	KPEP60/KS				
	Canal de blindage pour gaines murales PK (110, 140, 170 et 210x70 et 120x55)					
	Acier			59	20501	25,79/m
	↔ 2 m  12 m	KSK40X20S KSK40X33S		59	20501	28,90/m
	Etrier pour canaux de blindage SK (1 pc. = 12 étriers)					
	Matière synthétique	blanc		59	20501	3,75/pc.
	 5 pc.	KPSK1HB				
	Câble de connexion pour canaux de blindage SK					
	Cuivre			59	20501	5,14/pc.
	↔ 110 mm  10 pc.	KPLSK				

















Systemes de gaines murales PK

	type	référence	 stock	page. catal.	groupe d'articles	prix en €
	Prise simple 45X45, 3P16A230V, 45°, avec sécurité-enfants, blanc					
	Matière synthétique exempte d'halogènes	blanc	KQP45X45CHB	48	20501	12,86/pc.
	 10 pc.					
	Prise simple 45X45, 3P16A230V, 45°, avec sécurité-enfants, rouge					
	Matière synthétique exempte d'halogènes	rouge	KQP45X45CBB	48	20501	13,86/pc.
	 10 pc.					
	Boîte d'appareillage pour gaines murales PK (110, 140, 170 et 210X70)					
	Matière synthétique	blanc	KKPPKHB	✓	61	20501 5,46/pc.
	Matière synthétique exempte d'halogènes	blanc	KKPPKHFB	✓	56	20501 7,33/pc.
	 10 pc.					
	Adaptateur pour gaines murales PK (140 et 170X70)					
	Matière synthétique	blanc simple	K8440-11HB	✓	64	20501 3,69/pc.
	 10 pc.	blanc double	K8440-12HB	✓	64	20501 4,83/pc.
		blanc triple	K8440-13HB	✓	64	20501 7,88/pc.
	Adaptateur pour gaines murales PK (110 et 210X70)					
	Matière synthétique	blanc simple	K8450-11HB		64	20501 3,89/pc.
	 10 pc.	blanc double	K8450-12HB		64	20501 4,83/pc.
		blanc triple	K8450-13HB		64	20501 7,88/pc.
	Matière synthétique exempte d'halogènes	blanc simple	K8450-11HFHB	✓	56	20501 6,62/pc.
	 10 pc.	blanc double	K8450-12HFHB	✓	56	20501 8,06/pc.
		blanc triple	K8450-13HFHB	✓	56	20501 12,88/pc.
	Support d'appareillage CEE pour gaines murales PK (140 et 170X70)					
	Acier		KPNPKS	✓	63	20501 49,80/pc.

















Canal d'alimentation EKE

	type	référence	 stock	page. catal.	groupe d'articles	prix en €
	Base + couvercle EKE 60x60					
Matière synthétique	blanc	KEKE60X60HD		36	20503	10,67/m
↔ 2 m  18 m						
	Embout EKE 60x60					
Matière synthétique	blanc	K8541HB		36	20503	13,32/pc.
 2 pc.						
	Accouplement EKE 60x60					
Matière synthétique	blanc	K8542HB		36	20503	13,32/pc.
 2 pc.						
	Angle plat EKE 60x60					
Matière synthétique	blanc	K8543HB		36	20503	20,07/pc.
 2 pc.						
	Pièce en T EKE 60x60					
Matière synthétique	blanc	K8544HB		36	20503	13,32/pc.
 2 pc.						
	Angle intérieur EKE 60x60					
Matière synthétique	blanc	K8545HB		36	20503	13,32/pc.
 2 pc.						
	Angle extérieur EKE 60x60					
Matière synthétique	blanc	K8546HB		36	20503	13,32/pc.
 2 pc.						

















Systemes de gaines murales EKE

	type	référence	 stock	page. catal.	groupe d'articles	prix en €
	Base + couvercle EKE 100x60					
	Matière synthétique ↔ 2 m  8 m	blanc	KEKE100X60HD		37	20501
	Embout EKE 100x60					
	Matière synthétique  2 pc.	blanc	K8551HB		37	20506
	Accouplement EKE 100x60					
	Matière synthétique  2 pc.	blanc	K8552HB		37	20506
	Angle plat EKE 100x60					
	Matière synthétique  2 pc.	blanc	K8553HB		37	20506
	Pièce en T EKE 100x60					
	Matière synthétique  2 pc.	blanc	K8554HB		37	20506
	Angle intérieur EKE 100x60					
	Matière synthétique  2 pc.	blanc	K8555HB		37	20506
	Angle extérieur EKE 100x60					
	Matière synthétique  2 pc.	blanc	K8556HB		37	20506













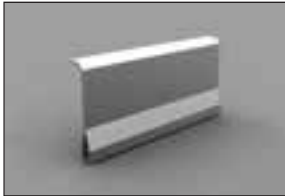



Systemes de gaines murales EKE

	type	réf�rence	 stock	page. catal.	groupe d'articles	prix en �
	Base + couvercle EKE 140x60					
	Mati�re synth�tique ↔ 2 m  6 m	blanc	KEKE140X60HD		38	20501
	Embout EKE 140x60					
	Mati�re synth�tique  2 pc.	blanc	K8561HB		38	20506
	Accouplement EKE 140x60					
	Mati�re synth�tique  2 pc.	blanc	K8562HB		38	20506
	Angle plat EKE 140x60					
	Mati�re synth�tique  2 pc.	blanc	K8563HB		38	20506
	Pi�ce en T EKE 140x60					
	Mati�re synth�tique  2 pc.	blanc	K8564HB		38	20506
	Angle int�rieur EKE 140x60					
	Mati�re synth�tique  2 pc.	blanc	K8565HB		38	20506
	Angle ext�rieur EKE 140x60					
	Mati�re synth�tique  2 pc.	blanc	K8566HB		38	20506

Systemes de gaines murales EKE

	type	référence	 stock	page. catal.	groupe d'articles	prix en €
	Base + couvercle EKE 180x60					
	Matière synthétique ↔ 2 m  6 m	blanc	KEKE180X60HD		39	20501
	Embout EKE 180x60					
	Matière synthétique  2 pc.	blanc	K8571HB		39	20506
	Accouplement EKE 180x60					
	Matière synthétique  2 pc.	blanc	K8572HB		39	20506
	Angle plat EKE 180x60					
	Matière synthétique  2 pc.	blanc	K8573HB		39	20506
	Pièce en T EKE 180x60					
	Matière synthétique  2 pc.	blanc	K8574HB		39	20506
	Angle intérieur EKE 180x60					
	Matière synthétique  2 pc.	blanc	K8575HB		39	20506
	Angle extérieur EKE 180x60					
	Matière synthétique  2 pc.	blanc	K8576HB		39	20506













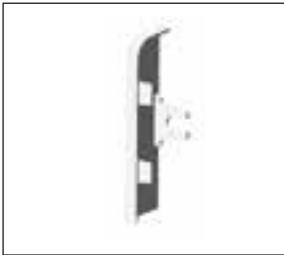

Systemes de gaines murales EKE

	type	référence	 stock	page. catal.	groupe d'articles	prix en €
	Cloison de séparation H= 45 mm					
	Matière synthétique					
	↔ 2 m  20 m	blanc	KPEKE60C	✓	57 20501	6,52/m
	Cloison de séparation H= 45 mm					
	Matière synthétique avec feuil métallique		KPKS70/60		57 20501	10,62/m
	↔ 2 m  20 m					
	Cloison de séparation H= 42,5 mm					
	Matière synthétique					
	↔ 2 m  32 m	blanc	KPEP60HD		58 20501	12,88/m
	Cloison de séparation H= 42,5 mm					
	Acier					
	↔ 2 m  24 m		KPEP60/KS		58 20501	30,21/m
	Boîte d'appareillage pour gaines murales EKE (100, 140 et 180X60)					
	Matière synthétique					
	 10 pc.	blanc	KKPEKEHB		61 20501	5,48/pc.
	Adaptateur pour gaines murales EKE (100x60)					
	Matière synthétique					
	 2 pc.	blanc simple	K8550-11HB		64 20501	3,88/pc.
		blanc double	K8550-12HB		64 20501	4,83/pc.
		blanc triple	K8550-13HB		64 20501	6,05/pc.
	Adaptateur pour gaines murales EKE (140x60)					
	Matière synthétique					
	 2 pc.	blanc simple	K8560-11HB		64 20501	4,40/pc.
		blanc simple	K8560-12HB		64 20501	5,69/pc.
		blanc simple	K8560-13HB		64 20501	7,51/pc.
	Support d'appareillage CEE pour gaines murales EKE (140 et 180X60)					
	Acier					
			KPNEKES		63 20501	49,80/pc.
	Canal de blindage pour gaines murales EKE (100, 140 et 180x60)					
	Acier					
	↔ 2 m  12 m		KSK40X20S		59 20501	25,79/m
			KSK40X33S		59 20501	28,90/m













Canaux de plinthe et de plafond LP35

	type	référence	stock	page. catal.	groupe d'articles	prix en €	
	Base + couvercle LP 35X25						
	Matière synthétique						
	↔ 2 m  20 m	blanc	KLP35HD	32	20504	9,49/m	
		bouleau rose	KLP35I1	32	20504	19,32/m	
		chêne foncé	KLP35I2	32	20504	19,32/m	
		brun clair	KLP35SD	32	20504	13,96/m	
		brun foncé	KLP35TD	32	20504	13,96/m	
	Embout gauche LP 35X25						
	Matière synthétique	 10 pc.	blanc	K8861LHB	32	20504	3,93/pc.
			bouleau rose	K8861LI1	32	20504	8,47/pc.
			chêne foncé	K8861LI2	32	20504	8,47/pc.
			brun clair	K8861LSD	32	20504	8,47/pc.
	Embout droit LP 35X25						
	Matière synthétique	 10 pc.	blanc	K8861PHB	32	20504	3,93/pc.
			bouleau rose	K8861PI1	32	20504	8,47/pc.
			chêne foncé	K8861PI2	32	20504	8,47/pc.
			brun clair	K8861PSD	32	20504	8,47/pc.
	Angle intérieur LP 35X25						
	Matière synthétique	 10 pc.	blanc	K8865HB	32	20504	3,93/pc.
			bouleau rose	K8865I1	32	20504	8,47/pc.
			chêne foncé	K8865I2	32	20504	8,47/pc.
		brun clair	K8865SD	32	20504	4,34/pc.	
	Angle extérieur LP 35X25						
	Matière synthétique	 10 pc.	blanc	K8866HB	32	20504	3,93/pc.
			bouleau rose	K8866I1	32	20504	8,47/pc.
			chêne foncé	K8866I2	32	20504	8,47/pc.
		brun clair	K8866SD	32	20504	4,34/pc.	
	Boîte d'appareillage pour gaines LP 35X25						
	Matière synthétique	 10 pc.	blanc	KPNLP352ZHB	63	20504	6,75/pc.
			bouleau rose	KPNLP352ZI1	63	20504	13,06/pc.
			chêne foncé	KPNLP352ZI2	63	20504	13,06/pc.
			brun clair	KPNLP352ZSD	63	20504	10,71/pc.











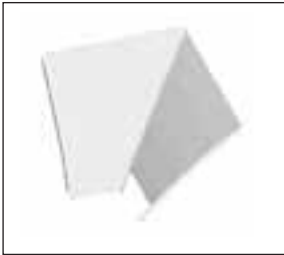

Canaux de plinthe LP80

	type	référence	 stock	page. catal.	groupe d'articles	prix en €
Base + couvercle LP 80X25 et LPK 80X25						
 <p>LP</p>	Matière synthétique					
	↔ 2 m  16 m	blanc	KLP80X25HD	30	20504	11,88/m
 <p>LPK</p>		blanc	KLPK80X25HD	31	20504	15,21/m
	Embout gauche et droit pour LP 80X25 et LPK 80X25					
	Matière synthétique					
	 10 pc.	blanc gauche	K8821LHB	30-31	20504	2,96/pc.
		blanc droit	K8821PHB	30-31	20504	2,96/pc.
Accouplement LP 80X25						
	Matière synthétique					
	 10 pc.	blanc	K8822HB	30-31	20504	2,96/pc.
Angle intérieur LP 80X25						
	Matière synthétique					
	 10 pc.	blanc	K8825HB	30-31	20504	4,02/pc.
Angle extérieur LP 80X25						
	Matière synthétique					
	 10 pc.	blanc	K8826HB	30-31	20504	4,02/pc.
Boîte d'appareillage pour gaines LP 80X25 et LPK 80X25						
	Matière synthétique					
	 10 pc.	blanc simple	KPN80X25HB	62	20504	7,73/pc.
		blanc double	KPN80X252ZHB	62	20504	7,98/pc.















Canaux de plinthe LP80

	type	référence	 stock	page. catal.	groupe d'articles	prix en €
	Transition de LP(K) 80X25 vers LHD 20X20					
	Matière synthétique					
	 10 pc.	blanc	K8824/12HB	30-31	20504	4,02/pc.
	Transition de LP(K) 80X25 vers LZK 15X12					
	Matière synthétique					
	 10 pc.	blanc	K8824/40HB	30-31	20504	4,02/pc.
	Transition de LP(K) 80X25 vers LZ 15X12					
	Matière synthétique					
	 10 pc.	blanc	K8824/41HB	30-31	20504	4,02/pc.
	Transition de LP(K) 80X25 vers LO 35					
	Matière synthétique					
	 10 pc.	blanc	K8824/43HB	30-31	20504	4,02/pc.
	Transition de LP(K) 80X25 vers LO 50					
	Matière synthétique					
	 10 pc.	blanc	K8824/44HB	30-31	20504	4,02/pc.
	Transition de LP(K) 80X25 vers LHD 40X20					
	Matière synthétique					
	 10 pc.	blanc gauche	K8823/13LHB	30-31	20504	4,02/pc.
		blanc droit	K8823/13PHB	30-31	20504	4,02/pc.















Canal LR30 et canaux avec couvercle à charnière LZ

	type	référence	 stock	page. catal.	groupe d'articles	prix en €
	Base + couvercle LR30					
	Matière synthétique					
	↔ 2 m  26 m	KLR30HB		29	20504	12,21/m
	Angle intérieur LR30					
	Matière synthétique					
	 5 pc.	K8855HB		29	20504	2,18/pc.
	Angle intérieur 3 entrées LR30					
	Matière synthétique					
	 5 pc.	K8855/3HB		29	20504	2,18/pc.
	Angle extérieur LR30					
	Matière synthétique					
	 10 pc.	K8856HB		29	20504	2,18/pc.
	Base + couvercle à charnière LZ 15X12					
	Matière synthétique					
	↔ 2 m  96 m	blanc K LZ15X12HD		8	20503	1,36/m
	Base + couvercle à charnière rond LZK 15X12					
	Matière synthétique					
	↔ 2 m  96 m	blanc K LZK15X12HD		9	20503	1,36/m













Canaux de sol LO

	type	référence	stock	page. catal.	groupe d'articles	prix en €	
	Base + couvercle LO 35						
	Matière synthétique						
	↔ 2 m	 60 m	blanc	KL035HD	26	20504	5,56/m
			blanc + autoc.	KL035P2	26	20504	5,86/m
			gris clair	KL035KD	26	20504	7,58/m
			gris foncé	KL035LD	26	20504	7,58/m
	Angle plat	 2 pc.	blanc	K8833HB	26	20504	3,06/pc.
			gris clair	K8833KB	26	20504	3,06/pc.
			gris foncé	K8833LB	26	20504	3,06/pc.
	Pièce en T	 2 pc.	blanc	K8834HB	26	20504	2,79/pc.
			gris clair	K8834KB	26	20504	2,79/pc.
			gris foncé	K8834LB	26	20504	2,79/pc.
	Base + couvercle LO 50						
	Matière synthétique						
	↔ 2 m	 32 m	blanc	KL050HD	27	20504	7,92/m
			blanc + autoc.	KL050P2	27	20504	8,89/m
			gris clair	KL050KD	27	20504	7,92/m
			gris foncé	KL050LD	27	20504	7,92/m
	Angle plat	 2 pc.	blanc	K8843HB	27	20504	3,40/pc.
			gris clair	K8843KB	27	20504	3,40/pc.
			gris foncé	K8843LB	27	20504	3,40/pc.
	Pièce en T	 2 pc.	blanc	K8844HB	27	20504	3,23/pc.
			gris clair	K8844KB	27	20504	3,23/pc.
			gris foncé	K8844LB	27	20504	3,23/pc.
	Base + couvercle LO 75						
	Matière synthétique						
	↔ 2 m	 28 m	blanc	KL075HD	28	20504	10,43/m
			blanc + autoc.	KL075P2	28	20504	12,99/m
			gris clair	KL075KD	28	20504	10,43/m
			gris foncé	KL075LD	28	20504	10,43/m
	Angle plat	 2 pc.	blanc	K8873HB	28	20504	4,00/pc.
			gris clair	K8873KB	28	20504	4,00/pc.
			gris foncé	K8873LB	28	20504	4,00/pc.
	Pièce en T	 2 pc.	blanc	K8874HB	28	20504	3,57/pc.
			gris clair	K8874KB	28	20504	3,57/pc.
			gris foncé	K8874LB	28	20504	3,57/pc.
	Pince pour réaliser des ouvertures						
	Matière synthétique / acier			KVK20	65	20503	332,29/pc.
	Pince pour canaux jusqu'à 40X20 mm ou Ø40 mm						
	Matière synthétique / acier			KL-42W	65	20503	193,72/pc.













Canaux d'alimentation LV, LH, LHD et EKD

	type	référence	stock	page. catal.	groupe d'articles	prix en €	
	Base + couvercle LV 11X10						
	Matière synthétique						
	↔ 2 m	 150 m	blanc KLV11X10HD blanc + autoc. KLV11X10P2	4 4	20503 20503	1,00/m 1,88/m	
	Base + couvercle LV 18X13						
	Matière synthétique						
	↔ 2 m	 70 m	blanc KLV18X13HD blanc + autoc. KLV18X13P2 brun clair KLV18X13SD brun foncé KLV18X13TD	5 5 5 5	20503 20503 20503 20503	1,38/m 2,45/m 1,85/m 1,85/m	
	Embout		blanc K8731HB	5	20503	1,02/pc.	
	Accouplement		blanc K8732HB	5	20503	1,02/pc.	
	Angle plat		blanc K8733HB	5	20503	1,54/pc.	
	Pièce en T	 10 pc.	blanc K8734HB	5	20503	1,54/pc.	
	Angle intérieur		blanc K8735HB	5	20503	1,54/pc.	
	Angle extérieur		blanc K8736HB	5	20503	1,54/pc.	
		Base + couvercle LV 24X22					
Matière synthétique							
↔ 2 m		 40 m	blanc KLV24X22HD	6	20503	2,17/m	
		 30 m	blanc + autoc. KLV24X22P2	6	20503	3,74/m	
Embout			blanc K8791HB	6	20503	1,16/pc.	
Accouplement			blanc K8792HB	6	20503	1,16/pc.	
Angle plat			blanc K8793HB	6	20503	1,66/pc.	
Pièce en T	 10 pc.	blanc K8794HB	6	20503	1,66/pc.		
Angle intérieur		blanc K8795HB	6	20503	1,66/pc.		
Angle extérieur		blanc K8796HB	6	20503	1,66/pc.		
	Base + couvercle LV 40X15						
	Matière synthétique						
	↔ 2 m	 30 m	blanc KLV40X15HD blanc + autoc. KLV40X15P2	7 7	20503 20503	4,28/m 5,45/m	
	Embout		blanc K8711HB	7	20503	1,77/pc.	
	Accouplement		blanc K8714HB	7	20503	1,77/pc.	
	Angle plat		blanc K8716HB	7	20503	2,07/pc.	
	Pièce en T	 10 pc.	blanc K8715HB	7	20503	2,07/pc.	
	Angle intérieur		blanc K8713/2HB	7	20503	2,07/pc.	
Angle extérieur		blanc K8712/2HB	7	20503	2,07/pc.		
	Base + couvercle LH 15X10						
	Matière synthétique						
	↔ 2 m	 128 m	blanc KLH15X10HD blanc + autoc. KLH15X10P2	✓ ✓	10 10	20503 20503	1,03/m 1,91/m
	Embout		blanc K8681HB	10	20503	0,82/pc.	
	Accouplement		blanc K8682HB	10	20503	0,82/pc.	
	Angle plat		blanc K8683HB	10	20503	1,22/pc.	
	Pièce en T	 10 pc.	blanc K8684HB	10	20503	1,22/pc.	
	Angle intérieur		blanc K8685HB	10	20503	1,22/pc.	
	Angle extérieur		blanc K8686HB	10	20503	1,22/pc.	













Canaux d'alimentation LV, LH, LHD et EKD

	type	référence	stock	page. catal.	groupe d'articles	prix en €		
Base + couvercle LHD 17X17								
Matière synthétique								
	↔ 2 m	 70 m	blanc	KLHD17X17HD	11	20503	1,43/m	
			blanc + autoc. KLHD17X17P2		11	20503	2,17/m	
			blanc	K8671HB	11	20503	1,04/pc.	
			blanc	K8672HB	11	20503	1,04/pc.	
		 10 pc.	blanc	K8673HB	11	20503	1,54/pc.	
			blanc	K8674HB	11	20503	1,54/pc.	
			blanc	K8675HB	11	20503	1,54/pc.	
			blanc	K8676HB	11	20503	1,54/pc.	
Base + couvercle LHD 20X10								
Matière synthétique								
	↔ 2 m	 96 m	blanc	KLHD20X10HD	12	20503	1,30/m	
			blanc + autoc. KLHD20X10P2		✓	12	20503	2,27/m
			blanc	K8921HB	12	20503	1,04/pc.	
			blanc	K8922HB	12	20503	1,04/pc.	
		 10 pc.	blanc	K8923HB	12	20503	1,54/pc.	
			blanc	K8924HB	12	20503	1,54/pc.	
			blanc	K8925HB	12	20503	1,54/pc.	
			blanc	K8926HB	12	20503	1,54/pc.	
Base + couvercle LHD 20X10 HF								
Matière synthétique exempte d'halogènes								
	↔ 2 m	 60 m	blanc	KLHD20X10HFHD	✓	49	20503	4,61/m
					✓	49	20503	3,34/pc.
			blanc	K8921HFHB	✓	49	20503	3,34/pc.
			blanc	K8922HFHB	✓	49	20503	3,34/pc.
		 10 pc.	blanc	K8923HFHB	✓	49	20503	4,93/pc.
			blanc	K8924HFHB	✓	49	20503	4,93/pc.
			blanc	K8925HFHB	✓	49	20503	4,93/pc.
			blanc	K8926HFHB	✓	49	20503	4,93/pc.
Base + couvercle LHD 20X20								
Matière synthétique								
	↔ 2 m	 48 m	blanc	KLHD20X20HD	✓	13	20503	1,77/m
			blanc + autoc. KLHD20X20P2		13	20503	3,02/m	
			brun clair KLHD20X20SD		13	20503	2,20/m	
			brun foncé KLHD20X20TD		13	20503	2,20/m	
	↔ 2 m	 24 m	bouleau rose	KLHD20X20I1	13	20503	16,44/m	
			chêne foncé	KLHD20X20I2	13	20503	16,44/m	
			blanc	K8621HB	✓	13	20503	1,10/pc.
			blanc	K8622HB	13	20503	1,10/pc.	
		 10 pc.	blanc	K8623HB	13	20503	1,74/pc.	
			blanc	K8624HB	13	20503	1,74/pc.	
			blanc	K8625HB	✓	13	20503	1,74/pc.
			blanc	K8626HB	13	20503	1,74/pc.	













Canaux d'alimentation LV, LH, LHD et EKD

	type	référence	stock	page. catal.	groupe d'articles	prix en €		
	Base + couvercle LHD 20X20 HF							
	Matière synthétique exempte d'halogènes							
	↔ 2 m	 24 m	blanc	KLHD20X20HFHD	✓	50	20503	7,10/m
	Embout		blanc	K8621HFHB	✓	50	20503	3,63/pc.
	Accouplement		blanc	K8622HFHB	✓	50	20503	3,63/pc.
	Angle plat	 10 pc.	blanc	K8623HFHB	✓	50	20503	5,29/pc.
	Pièce en T		blanc	K8624HFHB	✓	50	20503	5,29/pc.
		blanc	K8625HFHB	✓	50	20503	5,29/pc.	
		blanc	K8626HFHB	✓	50	20503	5,29/pc.	
	Base + couvercle LHD 25X15							
	Matière synthétique							
	↔ 2 m	 50 m	blanc	KLHD25X15HD	✓	14	20503	1,75/m
			blanc + autoc.	KLHD25X15P2		14	20503	3,02/m
	Embout		blanc	K8691HB	14	20503	1,14/pc.	
	Accouplement		blanc	K8692HB	14	20503	1,14/pc.	
	Angle plat	 10 pc.	blanc	K8693HB	14	20503	1,76/pc.	
Pièce en T		blanc	K8694HB	14	20503	1,76/pc.		
Angle intérieur		blanc	K8695HB	14	20503	1,76/pc.		
Angle extérieur		blanc	K8696HB	14	20503	1,76/pc.		
	Base + couvercle LHD 25X20							
	Matière synthétique							
	↔ 2 m	 40 m	blanc	KLHD25X20HD	15	20503	2,14/m	
			blanc + autoc.	KLHD25X20P2	15	20503	3,41/m	
	Embout		blanc	K8911HB	15	20503	1,16/pc.	
	Accouplement		blanc	K8912HB	15	20503	1,16/pc.	
	Angle plat	 10 pc.	blanc	K8913HB	15	20503	1,66/pc.	
Pièce en T		blanc	K8914HB	15	20503	1,66/pc.		
Angle intérieur		blanc	K8915HB	15	20503	1,66/pc.		
Angle extérieur		blanc	K8916HB	15	20503	1,66/pc.		
	Base + couvercle LHD 30X25							
	Matière synthétique							
	↔ 2 m	 48 m	blanc	KLHD30X25HD	✓	16	20503	2,40/m
			blanc + autoc.	KLHD30X25P2		16	20503	3,57/m
	Embout		blanc	K8931HB	16	20503	1,70/pc.	
	Accouplement		blanc	K8932HB	16	20503	1,70/pc.	
	Angle plat	 10 pc.	blanc	K8933HB	16	20503	2,39/pc.	
Pièce en T		blanc	K8934HB	16	20503	2,39/pc.		
Angle intérieur		blanc	K8935HB	16	20503	2,39/pc.		
Angle extérieur		blanc	K8936HB	16	20503	2,39/pc.		









Canaux d'alimentation LV, LH, LHD et EKD

	type	référence	stock	page. catal.	groupe d'articles	prix en €	
Base + couvercle LHD 32X15							
Matière synthétique							
	↔ 2 m	 88 m blanc	KLHD32X15HD	✓	17	20503 2,03/m	
		 80 m blanc + autoc.	KLHD32X15P2		17	20503 3,38/m	
	Embout	blanc	K8601HB	✓	17	20503 1,14/pc.	
	Accouplement	blanc	K8602HB	✓	17	20503 1,14/pc.	
	Angle plat	blanc	K8603HB	✓	17	20503 1,74/pc.	
	Pièce en T	 10 pc. blanc	K8604HB	✓	17	20503 1,74/pc.	
	Angle intérieur	blanc	K8605HB	✓	17	20503 1,74/pc.	
	Angle extérieur	blanc	K8606HB	✓	17	20503 1,74/pc.	
Base + couvercle LHD 40X20							
Matière synthétique							
	↔ 2 m	blanc	KLHD40X20HD	✓	18	20503 2,77/m	
		blanc + autoc.	KLHD40X20P2	✓	18	20503 4,34/m	
		brun clair	KLHD40X20SD		18	20503 4,24/m	
		brun foncé	KLHD40X20TD		18	20503 4,24/m	
	 12 m	bouleau rose	KLHD40X20I1		18	20503 19,11/m	
		chêne foncé	KLHD40X20I2		18	20503 19,11/m	
	Embout	blanc	K8631HB	✓	18	20503 2,10/pc.	
	Accouplement	blanc	K8632HB	✓	18	20503 2,10/pc.	
	Angle plat	blanc	K8633HB	✓	18	20503 2,84/pc.	
	Pièce en T	 10 pc. blanc	K8634HB	✓	18	20503 2,84/pc.	
	Angle intérieur	blanc	K8635HB	✓	18	20503 2,84/pc.	
	Angle extérieur	blanc	K8636HB	✓	18	20503 2,84/pc.	
Base + couvercle LHD 40X20 HF							
Matière synthétique exempte d'halogènes							
	↔ 2 m	 12 m blanc	KLHD40X20HFHD	✓	51	20503 11,72/m	
		Embout	blanc	K8631HFHB	✓	51	20503 6,33/pc.
		Accouplement	blanc	K8632HFHB	✓	51	20503 6,33/pc.
		Angle plat	blanc	K8633HFHB	✓	51	20503 8,90/pc.
		Pièce en T	 10 pc. blanc	K8634HFHB	✓	51	20503 8,90/pc.
		Angle intérieur	blanc	K8635HFHB	✓	51	20503 8,90/pc.
		Angle extérieur	blanc	K8636HFHB	✓	51	20503 8,90/pc.
Base + couvercle LHD 40X40							
Matière synthétique							
	↔ 2 m	blanc	KLHD40X40HD	✓	19	20503 4,45/m	
		brun clair	KLHD40X40SD		19	20503 8,63/m	
		brun foncé	KLHD40X40TD		19	20503 8,63/m	
	Embout	blanc	K8641HB	✓	19	20503 2,60/pc.	
	Accouplement	blanc	K8642HB		19	20503 2,60/pc.	
	Angle plat	blanc	K8643HB		19	20503 3,41/pc.	
	Pièce en T	 10 pc. blanc	K8644HB		19	20503 3,41/pc.	
	Angle intérieur	blanc	K8645HB	✓	19	20503 3,41/pc.	
	Angle extérieur	blanc	K8646HB		19	20503 3,41/pc.	

Canaux d'alimentation LV, LH, LHD et EKD

	type	référence	stock	page. catal.	groupe d'articles	prix en €		
	Base + couvercle LHD 40X40 HF							
	Matière synthétique exempte d'halogènes							
	↔ 2 m	 12 m	blanc	KLHD40X40HFHD	✓	52	20503	17,42/m
	Embout		blanc	K8641HFHB	✓	52	20503	8,06/pc.
	Accouplement		blanc	K8642HFHB	✓	52	20503	8,06/pc.
	Angle plat	 10 pc.	blanc	K8643HFHB	✓	52	20503	9,05/pc.
	Pièce en T		blanc	K8644HFHB	✓	52	20503	9,05/pc.
	Angle intérieur		blanc	K8645HFHB	✓	52	20503	9,05/pc.
	Angle extérieur		blanc	K8646HFHB	✓	52	20503	9,05/pc.
		Base + couvercle LHD 50x20, LHD 50x20/1 et LHD 50x20/2						
Matière synthétique								
↔ 2 m		 32 m	blanc	KLHD50X20HD		20	20503	3,62/m
			blanc	KLHD50X20/1HD		20	20503	3,84/m
			blanc	KLHD50X20/2HD		20	20503	4,13/m
Embout			blanc	K8991HB		20	20503	2,18/pc.
Accouplement			blanc	K8992HB		20	20503	2,18/pc.
Angle plat		 10 pc.	blanc	K8993HB		20	20503	3,09/pc.
Pièce en T			blanc	K8994HB		20	20503	3,09/pc.
Angle intérieur			blanc	K8995HB		20	20503	3,09/pc.
Angle extérieur		blanc	K8996HB		20	20503	3,09/pc.	
	Base + couvercle LH 60x40							
	Matière synthétique							
	↔ 2 m	 16 m	blanc	KLH60X40HD	✓	21	20503	8,17/m
	Embout		blanc	K8651HB		21	20503	3,04/pc.
	Accouplement		blanc	K8652HB	✓	21	20503	3,04/pc.
	Angle plat	 10 pc.	blanc	K8653HB		21	20503	4,13/pc.
	Pièce en T		blanc	K8654HB		21	20503	4,13/pc.
	Angle intérieur		blanc	K8655HB		21	20503	4,13/pc.
	Angle extérieur		blanc	K8656HB		21	20503	4,13/pc.
	Angle plat rond	 2 pc.	blanc	K8653RHB		21	20503	4,13/pc.
Pièce en T ronde		blanc	K8654RHB		21	20503	4,13/pc.	
	Base + couvercle EKD 80X40							
	Matière synthétique							
	↔ 2 m	 10 m	blanc	KEKD80X40HD		33	20503	9,95/m
	Embout		blanc	K8501HB		33	20503	4,59/pc.
	Accouplement		blanc	K8502HB		33	20503	4,59/pc.
	Angle plat		blanc	K8503HB		33	20503	6,52/pc.
	Pièce en T	 2 pc.	blanc	K8504HB		33	20503	6,28/pc.
	Dérivation		blanc	K8504/EKDHB		33	20503	5,92/pc.
	Angle intérieur		blanc	K8505HB		33	20503	6,52/pc.
	Angle extérieur		blanc	K8506HB		33	20503	6,52/pc.

Canaux d'alimentation LV, LH, LHD et EKD

	type	référence	stock	page. catal.	groupe d'articles	prix en €	
	Base + couvercle EKD 80X40 HF						
	Matière synthétique exempte d'halogènes						
	↔ 2 m	 10 m	blanc	KEKD80X40HFHD	53	20503	30,56/m
	Embout		blanc	K8501HFHB	53	20503	12,82/pc.
	Accouplement		blanc	K8502HFHB	53	20503	12,82/pc.
	Angle plat		blanc	K8503HFHB	53	20503	16,93/pc.
	Pièce en T	 2 pc.	blanc	K8504HFHB	53	20503	16,93/pc.
	Angle intérieur		blanc	K8505HFHB	53	20503	16,93/pc.
	Angle extérieur		blanc	K8506HFHB	53	20503	16,93/pc.
		Base + couvercle EKD 100X40					
Matière synthétique							
↔ 2 m		 8 m	blanc	KEKD100X40HD	34	20503	11,72/m
Embout			blanc	K8511HB	34	20503	6,05/pc.
Accouplement			blanc	K8512HB	34	20503	6,05/pc.
Angle plat			blanc	K8513HB	34	20503	7,98/pc.
Pièce en T		 2 pc.	blanc	K8514HB	34	20503	7,98/pc.
Dérivation			blanc	K8514/EKDHB	34	20503	7,98/pc.
Angle intérieur			blanc	K8515HB	34	20503	7,98/pc.
Angle extérieur			blanc	K8516HB	34	20503	7,98/pc.
	Base + couvercle EKD 120x40						
	Matière synthétique						
	↔ 2 m	 8 m	blanc	KEKD120X40HD	35	20503	13,86/m
	Embout		blanc	K8581HB	35	20503	6,45/pc.
	Accouplement		blanc	K8582HB	35	20503	6,45/pc.
	Angle plat		blanc	K8583HB	35	20503	9,68/pc.
	Pièce en T	 2 pc.	blanc	K8584HB	35	20503	9,68/pc.
	Dérivation		blanc	K8584/EKDHB	35	20503	9,68/pc.
	Angle intérieur		blanc	K8585HB	35	20503	9,68/pc.
	Angle extérieur		blanc	K8586HB	35	20503	9,68/pc.

Canaux de câblage RK

	type	référence	stock	page. catal.	groupe d'articles	prix en €	
<p>profondeur ↗ hauteur ↗</p>	Base + couvercle RK...X...						
	Matière synthétique gris pierre RAL 7030						
	↔ 2 m						
	hauteur x profondeur						
		64 m	30x30	KRK30X30LD	68	20505	7,60/m
		60 m	30x40	KRK30X40LD	68	20505	8,96/m
		48 m	40x60	KRK40X60LD	✓ 68	20505	9,12/m
		36 m	60x60	KRK60X60LD	✓ 68	20505	11,85/m
		32 m	80x60	KRK80X60LD	✓ 68	20505	16,56/m
		22 m	100x60	KRK100X60LD	✓ 68	20505	17,68/m
	40 m	40x80	KRK40X80LD	✓ 68	20505	11,21/m	
	36 m	60x80	KRK60X80LD	✓ 68	20505	13,20/m	
<p>profondeur ↗ hauteur ↗</p>	Base + couvercle RK...X...HF						
	Matière synthétique exempte d'halogènes gris clair RAL 7035						
↔ 2 m							
hauteur x profondeur							
	42 m	50x50	KRK50X50HFLD	69	20505	24,50/m	
	Canal de câblage flexible RK-OVK						
	Matière synthétique gris pierre RAL 7030						
	↔ 0,5 m						
		60 pc.	∅20	KRK-OVK20LA	69	20505	10,96/pc.
	36 pc.	∅30	KRK-OVK30LB	69	20505	11,52/pc.	
	24 pc.	∅40	KRK-OVK40LB	69	20505	13,33/pc.	
	Canal de câblage en spirale RK-ST						
	Matière synthétique						
		25 m	∅6	KRK-ST6H25	69	20505	1,66/m
		20 m	∅12	KRK-ST12H20	69	20505	2,69/m
	25 m	∅22	KRK-ST22H25	69	20505	7,23/m	

Colonnes de distribution et de bureau



Fonctionnalité supérieure design élancé

- ✓ disponible en version simple et double
- ✓ en aluminium anodisé ou blanc laqué RAL 9010
- ✓ les mécanismes 45x45 mm s'encliquettent directement dans l'ouverture du couvercle, sans faire usage de boîtes d'appareillage
- ✓ montage simple et rapide
- ✓ 3 types : installés comme colonne de bureau fixe, comme colonne tendue entre le plafond et le sol ou comme colonne mobile
- ✓ plusieurs accessoires et finitions possibles.



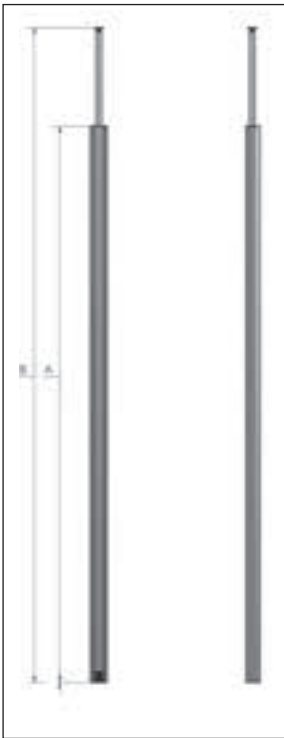

Caractéristiques	Tendue entre le sol et le plafond	Libre et mobile	Colonne de bureau
Aluminium, anodisé	✓	✓	✓
Aluminium, blanc laqué RAL 9010	✓	✓	✓
Dimensions (mm)	Profilé (plage de réglage) 2550 (2670-3070) 2750 (2870-3270) 3050 (3170-3570) 4000 (4120-4520)	Profilé (flexible) 2150 (2000) Diamètre socle 350	Profilé 683 Diamètre socle 170
Version simple	✓	✓	✓
Version double	✓	✓	✓
Mécanismes 45x45mm	✓	✓	✓
	page 240-241	page 242-243	page 244

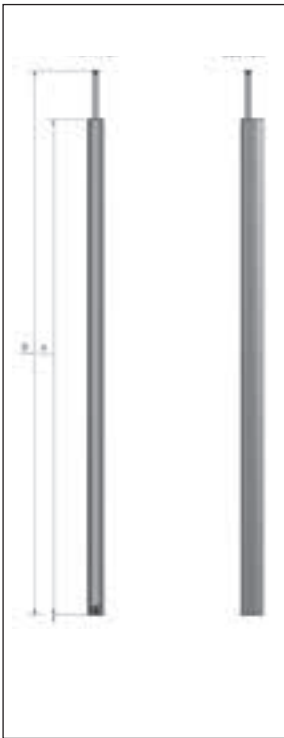

Colonnes de distribution IDT

	type	référence	 stock	page. catal.	groupe d'articles	prix en €	
Colonne de distribution tendue entre le sol et le plafond, simple							
	Aluminium						
		A	B				
	2550	2670-3070					
		anodisé	IDT6305	✓	5	20701	318,65/pc.
		blanc laqué	IDT6302	✓	5	20701	318,65/pc.
	2750	2870-3270					
		anodisé	IDT6306	✓	5	20701	332,66/pc.
		blanc laqué	IDT6303	✓	5	20701	332,66/pc.
	3050	3170-3570					
		anodisé	IDT6307	✓	5	20701	353,06/pc.
		blanc laqué	IDT6304	✓	5	20701	353,06/pc.
	4000	4120-4520					
	anodisé	IDT7218	✓	5	20701	486,86/pc.	
	blanc laqué	IDT7239	✓	5	20701	486,86/pc.	
Plaque de plafond, simple							
	Matière synthétique						
		blanc	IDT2917	✓	5	20701	10,57/pc.
Set avec conducteur de terre et serre-câbles							
							
			IDT6894	✓	5	20701	12,87/pc.

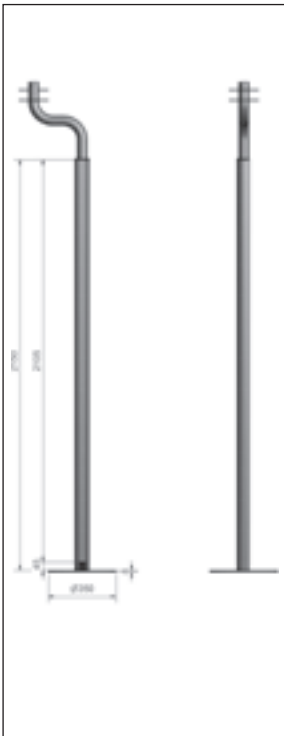

Colonnes de distribution IDT

	type	référence	 stock	page. catal.	groupe d'articles	prix en €	
Colonne de distribution tendue entre le sol et le plafond, double							
	Aluminium						
		A	B				
	2550	2670-3070 anodisé blanc laqué	IDT0022 IDT0019	✓ ✓	5 5	20701 20701	446,25/pc. 446,25/pc.
	2750	2870-3270 anodisé blanc laqué	IDT0023 IDT0020	✓ ✓	5 5	20701 20701	470,27/pc. 470,27/pc.
	3050	3170-3570 anodisé blanc laqué	IDT0024 IDT0021	✓ ✓	5 5	20701 20701	505,40/pc. 505,40/pc.
	4000	4120-4520 anodisé blanc laqué	IDT7219 IDT7240	✓ ✓	5 5	20701 20701	769,72/pc. 769,72/pc.
	Plaque de plafond, double						
		Matière synthétique					
			blanc	IDT6893	✓	5	20701
	Set avec conducteur de terre et serre-câbles						
							
				IDT6894	✓	5	20701

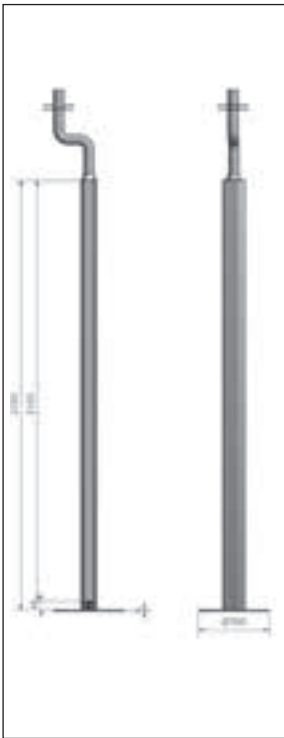

Colonnes de distribution IDT

	type	référence	 stock	page. catal.	groupe d'articles	prix en €
	Colonne de distribution mobile, simple. La plaque de plafond en acier laqué blanc et le flexible gris ou blanc L=2000 mm sont inclus					
	Aluminium	A				
	2150	anodisé blanc laqué	IDT6301 IDT6300	✓ ✓	7 7	20701 372,56/pc. 20701 372,56/pc.
	Le socle est à commander séparément.					
	Socle pour colonne de distribution mobile, simple					
	Acier					
		gris laqué blanc laqué	IDT2941 IDT2942	✓ ✓	7 7	20701 141,92/pc. 20701 141,92/pc.
	Set avec conducteur de terre et serre-câbles					
			IDT6894	✓	7	20701 12,87/pc.

Colonnes de distribution IDT

	type	référence	stock	page. catal.	groupe d'articles	prix en €
	Colonne de distribution mobile, double. La plaque de plafond en acier laqué blanc et le flexible gris ou blanc L=2000 mm sont inclus					
	Aluminium	A				
	2150	anodisé blanc laqué	IDT0010 IDT0009	✓ ✓	7 7	20701 474,15/pc. 20701 474,15/pc.
	Le socle est à commander séparément.					
	Socle pour colonne de distribution mobile, double					
	Acier					
		gris laqué blanc laqué	IDT0011 IDT0012	✓ ✓	7 7	20701 141,92/pc. 20701 141,92/pc.
	Set avec conducteur de terre et serre-câbles					
			IDT6894	✓	7	20701 12,87/pc.

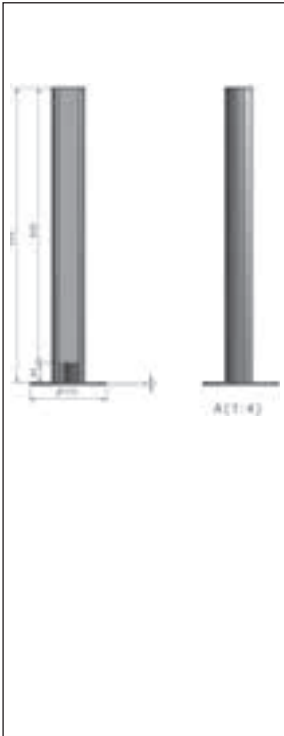
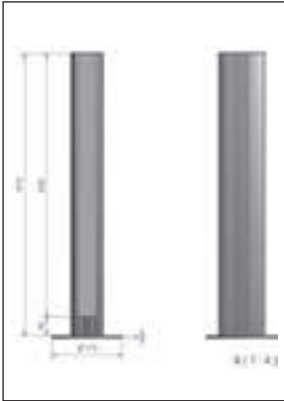
Colonnes de distribution IDT

	type	référence	 stock	page. catal.	groupe d'articles	prix en €
	Colonne de bureau, simple					
	Aluminium	anodisé blanc	IDT6299 IDT6298	✓ ✓	9 9	20701 182,72/pc. 20701 182,72/pc.
	Le socle rond est déjà fixé au profilé de la colonne de bureau.					
	Colonne de bureau, double					
	Aluminium	anodisé blanc	IDT0004 IDT0003	✓ ✓	9 9	20701 243,62/pc. 20701 243,62/pc.
	Le socle rond est déjà fixé au profilé de la colonne de bureau.					
	Set avec conducteur de terre et serre-câbles					
			IDT6894	✓	9	20701 12,87/pc.



Connexions bureautiques

Les connexions bureautiques **IBCONNECT** sont la solution idéale pour équiper tout lieu de travail de façon confortable et fonctionnelle de raccords pour des applications voix, données et multimédia ainsi que des prises électriques nécessaires. Une solution pour chaque application.

Grâce aux connexions bureautiques **IBCONNECT**, divers postes de travail, meubles de bureau et installations multimédia professionnelles répondent aux besoins actuels et futurs.



Box (page 249-251)



Cubo (page 248)



Cap (page 247)



Intro (page 252-254)



Prisma (page 255-256)



Top (page 246)



Meeting (page 246)



Unit (page 257)



Lumen (page 259)



PDC (page 246)



Orgatech (page 258)

Connexions bureautiques: PDC, TOP, MEETING



PDC – point de distribution 230V

En fonction de vos besoins, le PDC devient un point de distribution électrique pour une alimentation 230V.



PDC – point de distribution RJ45

En fonction de vos besoins, le PDC devient un point de distribution pour la transmission de données.



TOP

Boîtier de raccordement intégré à commande électrique. Les prises de courant et les raccordements de données et multimédia peuvent être combinés d'un côté.



MEETING

Boîtier de raccordement intégré à commande électrique. Les prises de courant et les raccordements de données et multimédia peuvent être combinés des deux côtés.

Configuration des types susmentionnés en fonction de vos besoins.

Connexions bureautiques: CAP

	type	référence	 stock	page. catal.	groupe d'articles	prix en €
	CAP Aluminium	blanc	44201004/1	-	20403	79,93/pc.
	CAP Aluminium	noir	44201004/2	-	20403	79,93/pc.
	CAP Aluminium	gris	44201004/4	-	20403	79,93/pc.
	CAP Plus Aluminium	noir	44202004/2	-	20403	100,00/pc.
	CAP Plus Aluminium	gris	44202004/4	-	20403	100,00/pc.

Connexions bureautiques: CUBO

	type	référence	 stock	page. catal.	groupe d'articles	prix en €
	CUBO 3 prises de courant + 1 espace vide (45x45) Profilé en aluminium laqué en blanc et mécanismes blancs	32102001F1	-		20401	57,24/pc.
	CUBO 3 prises de courant + 1 espace vide (45x45) Profilé en aluminium laqué en noir et mécanismes en anthracite	32102001F3	✓	-	20401	57,24/pc.
	CUBO 3 prises de courant + 2 espaces vides (45x45) Profilé en aluminium laqué en blanc et mécanismes blancs	32102002F1	-		20401	61,77/pc.
	CUBO 3 prises de courant + 2 espaces vides (45x45) Profilé en aluminium laqué en noir et mécanismes en anthracite	32102002F3	-		20401	61,77/pc.
	CUBO 4 prises de courant + support Profilé en aluminium laqué en blanc et mécanismes blancs	33106003F1	-		20401	75,24/pc.
	CUBO 4 prises de courant + support Profilé en aluminium laqué en noir et mécanismes en anthracite	33106003F3	-		20401	75,24/pc.

Connexions bureautiques: BOX

	type	référence	 stock	page. catal.	groupe d'articles	prix en €
	BOX 4 éléments					
	Aluminium	blanc	44101004/1	✓	-	20402 96,75/pc.
	BOX 4 éléments					
	Aluminium	noir	44101004/2	✓	-	20402 96,75/pc.
	BOX 4 éléments					
	Aluminium	gris	44101004/4	✓	-	20402 96,75/pc.
	BOX 6 éléments					
	Aluminium	blanc	44101006/1	✓	-	20402 108,73/pc.
	BOX 6 éléments					
	Aluminium	noir	44101006/2	✓	-	20402 108,73/pc.
	BOX 6 éléments					
	Aluminium	gris	44101006/4	✓	-	20402 108,73/pc.







Connexions bureautiques: BOX

	type	référence	 stock	page. catal.	groupe d'articles	prix en €
	CUBOBOX4 4 prises de courant Profilé en aluminium laqué en blanc et mécanismes blancs	34101003F1	-		20402	54,57/pc.
	CUBOBOX4 4 prises de courant Profilé en aluminium laqué en noir et mécanismes anthracite	34101003F3	✓	-	20402	54,57/pc.
	CUBOBOX4 3 prises de courant + 1 espace vide (45x45) Profilé en aluminium laqué en blanc et mécanismes blancs	32112001F1	✓	-	20402	53,40/pc.
	CUBOBOX4 3 prises de courant + 1 espace vide (45x45) Profilé en aluminium laqué en noir et mécanismes en anthracite	32112001F3	✓	-	20402	53,40/pc.
	CUBOBOX4 2 prises de courant + 2 espaces vides (45x45) Profilé en aluminium laqué en blanc et mécanismes blancs	32112002F1	✓	-	20402	48,55/pc.
	CUBOBOX4 2 prises de courant + 2 espaces vides (45x45) Profilé en aluminium laqué en noir et mécanismes en anthracite	32112002F3	✓	-	20402	48,55/pc.

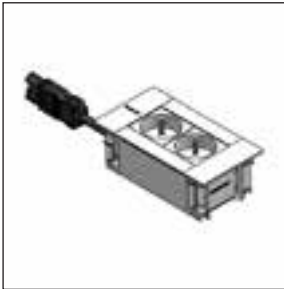

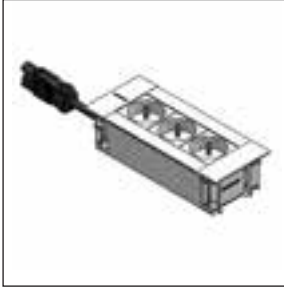
Connexions bureautiques: BOX

	type	référence	stock	page. catal.	groupe d'articles	prix en €
	CUBOBOX6 6 prises de courant Profilé en aluminium laqué en blanc et mécanismes blancs	34101005F1	-		20402	69,41/pc.
	CUBOBOX6 6 prises de courant Profilé en aluminium laqué en noir et mécanismes en anthracite	34101005F3	-		20402	69,41/pc.
	CUBOBOX6 3 prises de courant + 3 espaces vides (45x45) Profilé en aluminium laqué en blanc et mécanismes blancs	32112004F1	-		20402	59,81/pc.
	CUBOBOX6 3 prises de courant + 3 espaces vides (45x45) Profilé en aluminium laqué en noir et mécanismes en anthracite	32112004F3	✓	-	20402	59,81/pc.
	CUBOBOX6 4 prises de courant + 2 espaces vides (45x45) Profilé en aluminium laqué en blanc et mécanismes blancs	32112005F1	-		20402	63,21/pc.
	CUBOBOX6 4 prises de courant + 2 espaces vides (45x45) Profilé en aluminium laqué en noir et mécanismes en anthracite	32112005F3	✓	-	20402	63,21/pc.

Connexions bureautiques: INTRO

	type	référence	 stock	page. catal.	groupe d'articles	prix en €
	INTRO L=144 mm 2 prises de courant Profilé en aluminium laqué en blanc et mécanismes blancs	66101001F1	-	20404	59,66/pc.	
	INTRO L=144 mm 2 prises de courant Profilé en aluminium laqué en noir et mécanismes anthracite	66101001F3	-	20404	59,66/pc.	
	INTRO L=189 mm 3 prises de courant Profilé en aluminium laqué en blanc et mécanismes blancs	66101002F1	-	20404	70,41/pc.	
	INTRO L=189 mm 3 prises de courant Profilé en aluminium laqué en noir et mécanismes en anthracite	66101002F3	-	20404	70,41/pc.	
	INTRO L=279 mm 4 prises de courant Profilé en aluminium laqué en blanc et mécanismes blancs	66101003F1	-	20404	85,89/pc.	
	INTRO L=279 mm 4 prises de courant Profilé en aluminium laqué en noir et mécanismes en anthracite	66101003F3	-	20404	85,89/pc.	

Connexions bureautiques: INTRO

	type	référence	stock	page. catal.	groupe d'articles	prix en €
	INTRO L=279 mm					
	3 prises de courant + 1 espace vide (45x45)					
	Profilé en aluminium laqué en blanc et mécanismes blancs	66103003F1	-	20404		79,31/pc.
	INTRO L=279 mm					
	3 prises de courant + 1 espace vide (45x45)					
	Profilé en aluminium laqué en noir et mécanismes en anthracite	66103003F3	-	20404		79,31/pc.
	INTRO L=324 mm					
	3 prises de courant + 2 espaces vides (45x45)					
	Profilé en aluminium laqué en blanc et mécanismes blancs	66103004F1	-	20404		88,14/pc.
	INTRO L=324 mm					
	3 prises de courant + 2 espaces vides (45x45)					
	Profilé en aluminium laqué en noir et mécanismes en anthracite	66103004F3	-	20404		88,14/pc.
	INTRO L=369 mm					
	4 prises de courant + 2 espaces vides (45x45)					
	Profilé en aluminium laqué en blanc et mécanismes blancs	66103005F1	-	20404		95,94/pc.
	INTRO L=369 mm					
	4 prises de courant + 2 espaces vides (45x45)					
	Profilé en aluminium laqué en noir et mécanismes en anthracite	66103005F3	-	20404		95,94/pc.





Connexions bureautiques: INTRO

	type	référence	stock	page. catal.	groupe d'articles	prix en €
	INTRO L=189 mm					
	1 prise de courant + 1 x chargeur USB 5V/2A + 1 plaquette de montage 1 x RJ45 (connecteurs non inclus)	66103001F1	-	20404		72,36/pc.
	Profilé en aluminium laqué en blanc et mécanismes blancs					
	INTRO L=189 mm					
	1 prise de courant + 1 x chargeur USB 5V/2A + 1 plaquette de montage 1 x RJ45 (connecteurs non inclus)	66103001F3	-	20404		72,36/pc.
	Profilé en aluminium laqué en noir et mécanismes en anthracite					
	INTRO L=166 mm					
	2 prises de courant + 1 x chargeur USB 5V/2A	66103002F1	-	20404		89,55/pc.
	Profilé en aluminium laqué en blanc et mécanismes blancs					
	INTRO L=166 mm					
	2 prises de courant + 1 x chargeur USB 5V/2A	66103002F3	-	20404		89,55/pc.
	Profilé en aluminium laqué en noir et mécanismes en anthracite					
	INTRO L=549 mm					
	4 prises de courant + 1 ORGATECH	66108001F1	-	20404		139,06/pc.
	Profilé en aluminium laqué en blanc et mécanismes blancs					
	INTRO L=549 mm					
	4 prises de courant + 1 ORGATECH	66108001F3	-	20404		139,06/pc.
	Profilé en aluminium laqué en noir et mécanismes en anthracite					







Connexions bureautiques: PRISMA

	type	référence	stock	page. catal.	groupe d'articles	prix en €
	PRISMA 3 prises de courant + 1 espace vide (45x45) Coffret blanc, profilé noir et mécanismes en anthracite	blanc 26103001F1	-	20413	163,07/pc.	
	PRISMA 3 prises de courant + 1 espace vide (45x45) Coffret noir, profilé noir et mécanismes en anthracite	anthracite 26103001F3	-	20413	163,07/pc.	
	PRISMA 2 prises de courant + 2 espaces vides (45x45) Coffret blanc, profilé noir et mécanismes en anthracite	blanc 26103002F1	-	20413	163,07/pc.	
	PRISMA 2 prises de courant + 2 espaces vides (45x45) Coffret noir, profilé noir et mécanismes en anthracite	anthracite 26103002F3	-	20413	163,07/pc.	
	PRISMA 3 prises de courant + 1 x chargeur USB 5V/2A + 1 plaquette de montage 1 x RJ45 (connecteurs non inclus) Coffret blanc, profilé noir et mécanismes en anthracite	blanc 26103003F1	-	20413	203,73/pc.	
	PRISMA 3 prises de courant + 1 x chargeur USB 5V/2A + 1 plaquette de montage 1 x RJ45 (connecteurs non inclus) Coffret noir, profilé noir et mécanismes en anthracite	anthracite 26103003F3	-	20413	203,73/pc.	

Connexions bureautiques: PRISMA

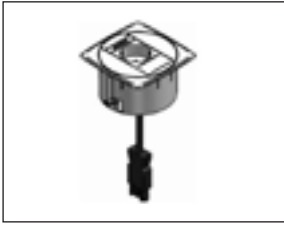
	type	référence	 stock	page. catal.	groupe d'articles	prix en €
	PRISMA SURFACE					
	3 prises de courant + 1 x chargeur USB 5V/2A + 1 plaquette de montage 1 x RJ45 (connecteurs non inclus)	blanc	26103006F1	-	20413	203,73/pc.
Coffret blanc, profilé noir et mécanismes en anthracite						
	PRISMA SURFACE					
	3 prises de courant + 1 x chargeur USB 5V/2A + 1 plaquette de montage 1 x RJ45 (connecteurs non inclus)	anthracite	26103006F3	-	20413	203,73/pc.
Coffret noir, profilé noir et mécanismes en anthracite						
	PRISMA SUPPORT					
	2 prises de courant + 1 x chargeur USB 5V/2A	blanc	26106005F1	-	20413	216,42/pc.
Coffret blanc, profilé noir et mécanismes en anthracite						
	PRISMA SUPPORT					
	2 prises de courant + 1 x chargeur USB 5V/2A	anthracite	26106005F3	-	20413	216,42/pc.
Coffret noir, profilé noir et mécanismes en anthracite						

Connexions bureautiques: UNIT

	type	référence	 stock	page. catal.	groupe d'articles	prix en €
	UNIT pour table comme passage de câbles					
	Matière synthétique					
	blanc	46100001/1	-	20411		25,64/pc.
	gris	46100001/3	-	20411		25,64/pc.
	UNIT pour table avec prise de courant et plaque aveugle 22,5 mm					
	Matière synthétique					
	blanc	46101001F1	-	20411		51,65/pc.
	gris	46101001F3	-	20411		51,65/pc.
	UNIT pour table avec prise de courant et plaque de montage pour RJ45					
	Matière synthétique					
	blanc	46102001F1	-	20411		58,31/pc.
	gris	46102001F3	-	20411		58,31/pc.
	UNIT pour table avec prise de courant et chargeur USB 5V/2A					
	Matière synthétique					
	blanc	46203002F1	-	20411		88,31/pc.
	gris	46203002F3	-	20411		88,31/pc.
	UNIT pour table avec prise de courant et chargeur USB 5V/2A, 1 chargeur USB type C					
	Matière synthétique					
	blanc	46203023F1	-	20411		113,87/pc.
	gris	46203023F3	-	20411		113,87/pc.
	UNIT pour sol rehaussé avec adaptateur pour ORGATECH					
	Matière synthétique					
	blanc	46100002/1	-	20411		26,46/pc.
	gris	46100002/3	-	20411		26,46/pc.

Connexions bureautiques: ORGATECH

	type	référence	 stock	page. catal.	groupe d'articles	prix en €
	ORGATECH L= 800 mm + 5 fixations					
	Matière synthétique					
	transparent	92114001	✓	-	20412	49,08/set
	blanc	92114001/1		-	20412	41,16/set
	gris	92114001/3		-	20412	41,16/set
	ORGATECH 2 anneaux + 2 fixations					
	Matière synthétique					
	transparent	92114007		-	20412	22,31/set
	ORGATECH embase + 4 anneaux					
	Acier laqué en noir					
	transparent	92114002		-	20412	19,43/pc.
	blanc	92114002/1		-	20412	18,57/pc.
	gris	92114002/3		-	20412	18,57/pc.
	ORGATECH dérivation (1 set = 5 dérivation)					
	Matière synthétique					
		92114003		-	20412	17,20/set
	ORGATECH fixation (1 set = 5 fixations)					
	Matière synthétique					
		92114004		-	20412	16,33/set
	Adaptateur femelle pour Orgatech (1 set = 5 pièces)					
	Matière synthétique					
	blanc	92114005/1		-	20412	11,19/set
	anthracite	92114005/3		-	20412	11,19/set
	Adaptateur mâle pour Orgatech (1 set = 5 pièces)					
	Matière synthétique					
	blanc	92114006/1		-	20412	11,19/set
	anthracite	92114006/3		-	20412	11,19/set



Connexions bureautiques: LUMEN

	type	référence	 stock	page. catal.	groupe d'articles	prix en €
	LUMEN	1 tube fluorescent 18W + 2 prises de courant + interrupteur				
	Aluminium	gris 74109001F3	-	20405		200,75/pc.
	LUMEN	1 tube fluorescent 18W + 2 prises de courant + interrupteur + entrée et sortie				
	Aluminium	gris 74109002F3	-	20405		210,77/pc.
	LUMEN	1 tube fluorescent 36 W + 2 prises de courant + interrupteur				
	Aluminium	gris 74109003F3	-	20405		242,75/pc.
	LUMEN 1	1 tube fluorescent 36 W + 2 prises de courant + interrupteur + entrée et sortie				
	Aluminium	gris 74109004F3	-	20405		252,63/pc.
	LUMEN	1 tube fluorescent 58W + 3 prises de courant + interrupteur				
	Aluminium	gris 74109005F3	-	20405		301,04/pc.
	LUMEN	1 tube fluorescent 58W + 3 prises de courant + interrupteur + entrée et sortie				
	Aluminium	gris 74109006F3	-	20405		307,81/pc.

Connexions bureautiques: plaques de montage

	type	référence	 stock	page. catal.	groupe d'articles	prix en €
	Plaque de montage (45 x 22.5): 1 x module VGA					
	blanc	91113029/1	-	20407		26,02/pc.
	anthracite	91113029/3	-	20407		26,02/pc.
	Plaque de montage (45 x 22.5): 1 x module stéréo					
	blanc	91113003/1	-	20407		11,75/pc.
	anthracite	91113003/3	-	20407		11,75/pc.
	Plaque de montage (45 x 45): 1 x XLR module 3 broches					
	blanc	91113004/1	-	20407		35,38/pc.
	anthracite	91113004/3	-	20407		35,38/pc.
	Plaque de montage (45 x 22.5): 1 x module BNC					
	blanc	91113005/1	-	20407		14,12/pc.
	anthracite	91113005/3	-	20407		14,12/pc.
	Plaque de montage (45 x 22.5): 1 x module RCA					
	blanc	91113006/1	-	20407		11,55/pc.
	anthracite	91113006/3	-	20407		11,55/pc.
	Plaque de montage (45 x 22.5): 1 x module F					
	blanc	91113007/1	-	20407		3,62/pc.
	anthracite	91113007/3	-	20407		3,62/pc.
	Plaque de montage (45 x 22.5): 1 x module USB 2.0 A/A					
	blanc	91113009/1	✓	-	20407	17,74/pc.
	anthracite	91113009/3	✓	-	20407	17,74/pc.

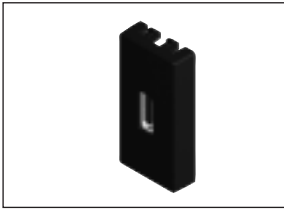
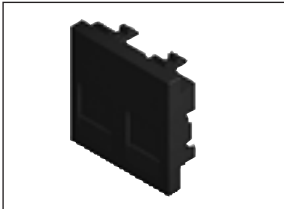
Connexions bureautiques: plaques de montage

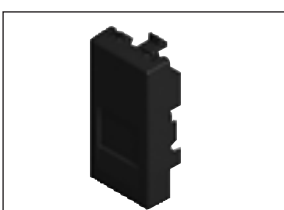
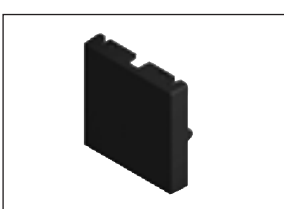
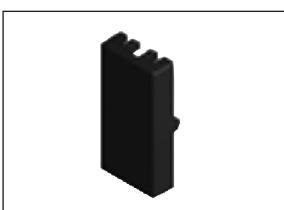
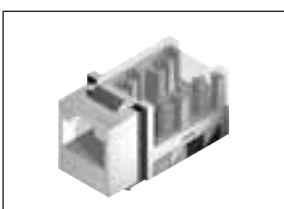
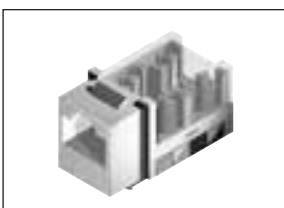
	type	référence	 stock	page. catal.	groupe d'articles	prix en €
	Plaque de montage (45 x 22.5): 1 x module HDMI					
	blanc	91113010/1	✓	-	20407	49,42/pc.
	anthracite	91113010/3	✓	-	20407	49,42/pc.
	Plaque de montage (45 x 45): 2 x module RJ45 (connecteurs non inclus)					
	blanc	91113011/1	✓	-	20407	5,76/pc.
	anthracite	91113011/3	✓	-	20407	5,76/pc.
	Plaque de montage (45 x 45): 1 x module RJ45 (connecteurs non inclus)					
	blanc	91113019/1		-	20407	5,32/pc.
	anthracite	91113019/3		-	20407	5,32/pc.
	Plaque de montage (45 x 22.5): 1 x module RJ 45 (connecteur non inclus)					
	blanc	91113012/1	✓	-	20407	4,66/pc.
	anthracite	91113012/3	✓	-	20407	4,66/pc.
	Plaque de montage (45 x 45): aveugle					
	blanc	91113013/1	✓	-	20407	1,62/pc.
	anthracite	91113013/3	✓	-	20407	1,62/pc.
	Plaque de montage (45 x 22.5): aveugle					
	blanc	91113014/1	✓	-	20407	1,32/pc.
	anthracite	91113014/3	✓	-	20407	1,32/pc.
	Connecteur CAT5e femelle					
	RJ45	91112001	✓	-	20407	9,00/pc.
	Connecteur CAT6 femelle					
	RJ45	91112002	✓	-	20407	11,75/pc.

Connexions bureautiques: accessoires

	type	référence	 stock	page. catal.	groupe d'articles	prix en €
	Connecteur CAT5e femelle/femelle					
	CAT5e	91112003	✓	-	20407	5,17/pc.
	Connecteur CAT6 femelle/femelle					
	CAT6	91112004	✓	-	20407	5,82/pc.
	CAT6A	91112006		-	20407	9,43/pc.
	Connecteur en T GST 18T					
	noir	91111001/2		-	20407	4,88/pc.
	Connecteur GST18 mâle, 3 pôles					
	noir	91111002/2		-	20407	2,66/pc.
	rouge	91111002/6		-	20407	2,84/pc.
	Connecteur GST18 femelle, 3 pôles					
	noir	91111003/2		-	20407	2,66/pc.
	rouge	91111003/6		-	20407	2,84/pc.
	Connexion intermédiaire GST 18					
	noir	91111005/2		-	20407	4,37/pc.
	Distributeur in: 1 GST18, mâle noir; out: 6GST18, femelle noir					
	Aluminium	noir	33105001		-	20407 90,22/pc.
	Distributeur in: 1 GST18, mâle noir et 1 GST18 mâle rouge; out: 6 GST18, femelle noir et 6 GST18 femelle rouge					
	Aluminium	noir/rouge	33105002		-	20407 157,47/pc.

Connexions bureautiques: accessoires

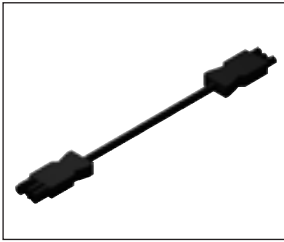
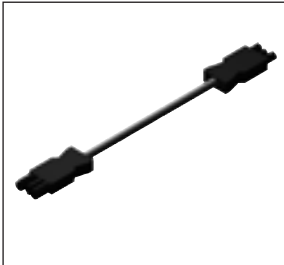
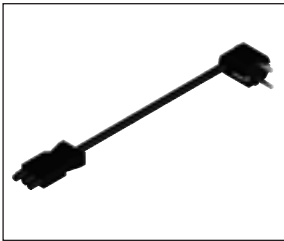
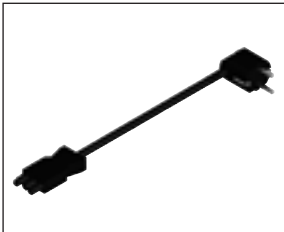
	type	référence	 stock	page. catal.	groupe d'articles	prix en €
	Câble de rallonge GST18 3-polaire mâle / GST18 3-polaire femelle; câble HO5VV-F 3G2,5					
	1m noir	91110008/2	-	20407	19,69/pc.	
	1m rouge	91110008/6	-	20407	25,18/pc.	
	2m noir	91110009/2	-	20407	22,37/pc.	
	2m rouge	91110009/6	-	20407	27,64/pc.	
	3m noir	91110010/2	-	20407	27,18/pc.	
3m rouge	91110010/6	-	20407	33,83/pc.		
	Câble de rallonge GST18 3-polaire mâle / GST18 3-polaire femelle, câble exempt d'halogènes JZ500 HMH 3G2,5					
	1m noir	91110020/2	-	20407	22,90/pc.	
	1m rouge	91110020/6	-	20407	28,33/pc.	
	2m noir	91110012/2	-	20407	26,94/pc.	
	2m rouge	91110012/6	-	20407	33,57/pc.	
	3m noir	91110014/2	-	20407	33,50/pc.	
3m rouge	91110014/6	-	20407	35,87/pc.		
	Câble de raccordement GST 18 3-polaire femelle ; câble HO5VV-F 3G2,5 ; fiche					
	2m noir	91110006F2	✓	-	20407	20,32/pc.
	2m rouge	91110006F6	-	-	20407	25,73/pc.
	3m noir	91110007F2	✓	-	20407	25,66/pc.
3m rouge	91110007F6	-	-	20407	32,13/pc.	
	Câble de raccordement GST 18 3-polaire femelle ; câble exempt d'halogènes JZ-500 HMH 3G2,5 ; fiche					
	2m noir	91110016F2	-	20407	27,18/pc.	
	2m rouge	91110016F6	-	20407	33,28/pc.	
	3m noir	91110018F2	-	20407	32,56/pc.	
3m rouge	91110018F6	-	20407	40,66/pc.		

Index

référence	prix en €	page	référence	prix en €	page	référence	prix en €	page	référence	prix en €	page
40611	2,52/pc.	56	709017	16,41/pc.	21	715723	70,78/pc.	56	716245	479,67/pc.	27
40616	3,37/pc.	56	709018	14,81/pc.	21	715724	86,09/pc.	15	716246	481,87/pc.	27
40631	7,28/pc.	56	709019	3,60/pc.	22	715724	86,09/pc.	56	716247	813,95/pc.	27
70510	2,88/pc.	42	709020	6,55/pc.	23	715725	109,04/pc.	15	716248	642,46/pc.	27
80100	1,65/pc.	45	709021	5,98/pc.	23	715725	109,04/pc.	56	716250	692,65/pc.	27
80200	4,49/pc.	57	709031	173,20/m	17	715726	142,33/pc.	15	716251	696,86/pc.	27
80201	8,65/pc.	57	709050	2,62/pc.	32	715726	142,33/pc.	56	716253	818,21/pc.	27
80202	3,69/pc.	57	709051	2,62/pc.	32	715727	178,83/pc.	15	716254	966,24/pc.	27
80602	2,85/pc.	56	709052	2,90/pc.	32	715727	178,83/pc.	56	716255	612,49/pc.	28
80603	4,61/pc.	56	709053	2,90/pc.	32	715728	296,12/pc.	15	716257	627,25/pc.	28
80604	5,64/pc.	56	709054	2,90/pc.	32	715728	296,12/pc.	56	716258	637,59/pc.	28
80605	9,42/pc.	56	709055	3,54/pc.	32	715735	1,67/pc.	36	716259	655,27/pc.	28
80606	11,94/pc.	56	709056	3,54/pc.	32	715736	2,18/pc.	36	716260	656,03/pc.	28
80607	18,53/pc.	56	709057	3,54/pc.	32	715879	20,67/m	16	716261	1070,03/pc.	28
80610	12,25/pc.	56	709058	3,54/pc.	32	716066	217,80/pc.	24	716262	1062,13/pc.	28
81501	3,37/pc.	57	709795	92,43/m	16	716067	217,80/pc.	24	716264	1145,03/pc.	28
81503	4,11/pc.	57	709798	122,88/m	17	716069	231,06/pc.	24	716265	1174,88/pc.	28
81504	sur demande	46	709799	309,75/pc.	15	716070	233,38/pc.	24	716267	1279,71/pc.	28
81512	sur demande	46	709801	20,15/pc.	19	716071	249,58/pc.	24	716268	1505,10/pc.	28
81522	sur demande	46	711205	28,30/pc.	29	716072	268,80/pc.	24	716276	115,59/pc.	15
81532	sur demande	46	712015	116,28/m	9	716073	545,23/pc.	24	716277	139,36/pc.	15
81542	sur demande	46	712017	119,34/m	9	716074	271,01/pc.	24	716278	170,26/pc.	15
81550	sur demande	46	712018	126,43/m	9	716075	298,19/pc.	24	716279	234,28/pc.	15
81552	sur demande	46	712019	121,93/m	9	716077	329,13/pc.	24	716280	327,88/pc.	15
81562	sur demande	46	712020	127,87/m	9	716078	352,63/pc.	24	716281	526,80/pc.	15
81572	sur demande	46	712465	213,24/pc.	11	716079	398,95/pc.	24	716282	565,64/pc.	15
81582	sur demande	46	712639	15,78/pc.	34	716080	400,93/pc.	24	716283	65,16/pc.	14
81710	15,89/pc.	55	712640	17,10/pc.	34	716081	601,00/pc.	24	716284	68,38/pc.	14
81712	11,53/pc.	55	712642	17,38/pc.	34	716179	323,19/pc.	24	716285	74,58/pc.	14
81715	16,23/pc.	55	712643	20,42/pc.	34	716180	345,82/pc.	24	716286	81,33/pc.	14
81720	17,44/pc.	55	712644	24,59/pc.	34	716182	370,85/pc.	24	716287	93,46/pc.	14
81722	13,86/pc.	55	712645	26,32/pc.	34	716183	403,37/pc.	24	716293	31,78/pc.	17
81730	23,61/pc.	55	713153	12,22/pc.	18	716184	442,21/pc.	24	716294	18,86/pc.	18
81731	12,28/pc.	55	713173	38,50/pc.	19	716185	448,63/pc.	24	716295	18,70/pc.	18
81732	17,94/pc.	55	713177	19,28/pc.	19	716186	360,47/pc.	24	716302	49,47/pc.	19
81733	26,87/pc.	55	713178	20,34/pc.	19	716187	410,27/pc.	24	716303	25,30/pc.	19
81740	28,20/pc.	55	713203	17,14/pc.	22	716189	463,16/pc.	24	716304	26,54/pc.	19
81742	24,24/pc.	55	713204	16,45/pc.	22	716190	529,85/pc.	24	716306	49,48/m	16
81752	31,66/pc.	55	713207	24,32/pc.	22	716191	681,30/pc.	24	716307	131,46/m	16
81762	40,37/pc.	55	713208	23,13/pc.	22	716192	691,67/pc.	24	716308	158,91/m	17
81977	0,08/pc.	58	713684	0,83/m	31	716193	239,83/pc.	25	716309	34,39/m	16
84400	1,54/pc.	55	713685	0,83/m	31	716194	243,51/pc.	25	716389	235,88/pc.	27
84901	1,88/pc.	57	713686	2,48/m	31	716196	252,37/pc.	25	716390	240,28/pc.	27
86510	13,82/pc.	55	713687	2,76/m	31	716197	268,60/pc.	25	716391	242,33/pc.	27
86520	16,23/pc.	55	713694	1,07/pc.	37	716198	273,79/pc.	25	716392	243,37/pc.	27
86530	18,33/pc.	55	714021	64,78/pc.	11	716199	290,02/pc.	25	716393	277,92/pc.	27
86540	19,84/pc.	55	714022	82,64/pc.	11	716200	667,09/pc.	25	716395	252,05/pc.	27
88520	1,28/pc.	46	714023	107,39/pc.	11	716201	547,35/pc.	25	716396	259,45/pc.	27
88540	0,39/pc.	47	714024	247,42/pc.	11	716202	414,43/pc.	25	716397	275,23/pc.	27
88550	1,08/pc.	46	714029	28,93/pc.	12	716204	454,38/pc.	25	716398	298,86/pc.	27
88701	6,57/m	45	714058	96,03/m	9	716205	479,26/pc.	25	716399	310,85/pc.	27
88705	0,52/pc.	45	714059	96,03/m	9	716206	534,94/pc.	25	716400	300,32/m	9
88712	6,13/pc.	45	714061	99,69/m	9	716207	536,04/pc.	25	716401	401,71/m	9
88722	6,49/pc.	45	714062	104,31/m	9	716208	743,17/pc.	25	716640	4,84/pc.	29
88732	7,01/pc.	45	714063	111,94/m	9	716209	374,15/pc.	25	716792	4,93/m	13
88742	7,41/pc.	45	714064	116,80/m	9	716210	375,63/pc.	25	716792	4,93/m	145
88752	8,47/pc.	45	714066	17,35/pc.	20	716212	384,47/pc.	25	716793	4,93/m	13
89077	0,15/pc.	58	714067	18,29/pc.	21	716213	397,75/pc.	25	716821	5,18/pc.	57
89177	0,24/pc.	58	714085	18,90/pc.	21	716214	406,61/pc.	25	716824	5,80/pc.	30
705093	31,54/m	16	714165	12,90/pc.	12	716215	418,42/pc.	25	717001	25,31/pc.	12
705304	10,77/pc.	20	714168	119,60/pc.	23	716216	589,63/pc.	25	717191	16,39/pc.	14
705392	24,24/pc.	20	714179	31,14/pc.	27	716217	602,39/pc.	25	717192	18,33/pc.	14
705394	27,78/pc.	20	714198	213,65/m	9	716218	654,59/pc.	25	717193	19,27/pc.	14
705395	29,83/pc.	20	714200	218,53/m	9	716220	707,22/pc.	25	717194	26,92/pc.	14
705396	34,83/pc.	20	714201	232,85/m	9	716221	738,31/pc.	25	717195	31,66/pc.	14
705397	35,40/pc.	20	714202	223,41/m	9	716222	770,03/pc.	25	717196	22,79/pc.	14
706415	13,49/set	28	714203	234,23/m	9	716223	824,69/pc.	25	717196	22,79/pc.	56
707511	9,97/pc.	12	714227	78,54/pc.	26	716224	1156,88/pc.	25	717196	22,79/pc.	144
707609	70,47/pc.	26	714700	73,06/pc.	11	716241	435,40/pc.	27	717197	26,04/pc.	14
707748	107,25/pc.	23	715675	15,89/pc.	18	716243	447,95/pc.	27	717197	26,04/pc.	56
708001	22,02/pc.	27	715723	70,78/pc.	15	716244	458,99/pc.	27	717197	26,04/pc.	144

Index

référence	prix en €	page	référence	prix en €	page	référence	prix en €	page	référence	prix en €	page
717198	29,56/pc.	14	718597	287,93/m	8	721962	673,93/pc.	25	725559	103,63/pc.	14
717198	29,56/pc.	56	718618	26,17/pc.	29	721963	1045,20/pc.	25	725560	111,06/pc.	14
717198	29,56/pc.	144	718624	52,24/pc.	11	721964	363,82/pc.	26	725561	135,42/pc.	14
717199	33,93/pc.	14	718625	56,55/pc.	11	723057	638,99/pc.	24	725562	109,76/pc.	14
717199	33,93/pc.	56	718626	64,99/pc.	11	723061	160,38/pc.	24	725563	127,99/pc.	14
717199	33,93/pc.	144	718627	73,60/pc.	11	723062	170,21/pc.	24	725564	162,07/pc.	14
717200	38,97/pc.	14	718628	82,14/pc.	11	723063	173,27/pc.	24	725565	213,76/pc.	14
717200	38,97/pc.	56	718632	4,10/pc.	37	723064	203,37/pc.	24	725566	276,35/pc.	14
717201	68,62/pc.	14	718640	15,43/pc.	17	723065	211,04/pc.	24	725567	445,15/pc.	15
717202	74,43/pc.	14	718643	34,83/pc.	28	723212	43,99/pc.	25	725568	549,03/pc.	15
717203	84,53/pc.	14	718644	38,32/pc.	28	723260	877,47/pc.	24	725569	661,00/pc.	15
717204	100,93/pc.	14	718660	476,28/pc.	33	723390	198,52/m	9	725570	861,31/pc.	15
717205	112,33/pc.	14	718718	352,87/pc.	15	723391	203,17/m	9	725571	1071,08/pc.	15
717618	21,68/pc.	19	718719	421,89/pc.	15	723392	207,16/m	9	725572	1510,85/pc.	15
717637	112,16/pc.	33	718720	557,21/pc.	15	723393	215,49/m	9	725573	51,77/pc.	17
717640	28,91/pc.	19	718721	622,51/pc.	15	723394	215,94/m	9	725574	21,20/pc.	16
717641	38,10/pc.	19	718793	100,55/pc.	11	723432	14,41/pc.	10	725575	28,26/pc.	16
717642	56,76/pc.	19	718808	122,88/m	17	723433	14,57/pc.	10	725576	35,33/pc.	16
717643	46,73/pc.	19	718835	11,82/pc.	30	723433	14,57/pc.	144	725577	50,39/pc.	16
717644	47,13/pc.	19	718849	36,72/pc.	19	723434	14,94/pc.	10	725578	70,63/pc.	16
717645	66,42/pc.	19	718850	148,38/pc.	18	723434	14,94/pc.	144	725579	70,63/m	16
717982	116,28/m	9	718851	164,13/pc.	18	723435	16,88/pc.	10	725582	9,11/pc.	37
717983	119,34/m	9	718903	170,81/pc.	20	723436	17,20/pc.	10	725590	59,37/m	31
717984	121,93/m	9	718904	17,48/pc.	20	723436	17,20/pc.	144	725591	92,23/m	31
717985	126,43/m	9	720252	sur demande	27	723437	27,19/pc.	10	725592	149,37/m	31
717986	127,87/m	9	720266	sur demande	28	723437	27,19/pc.	144	725593	65,45/pc.	30
718176	250,21/pc.	26	720517	243,37/pc.	27	723438	35,95/pc.	10	725594	95,99/pc.	30
718177	261,17/pc.	26	720518	286,91/pc.	27	723439	37,75/pc.	10	725618	95,99/pc.	11
718179	267,62/pc.	26	720521	688,63/pc.	15	723440	44,68/pc.	10	725619	97,47/pc.	11
718180	283,04/pc.	26	720522	819,64/pc.	15	723441	44,68/pc.	10	725620	100,49/pc.	11
718181	287,34/pc.	26	720523	1016,39/pc.	15	723442	45,42/pc.	10	725621	117,11/pc.	11
718182	297,27/pc.	26	720524	1125,19/pc.	15	723443	53,31/pc.	10	725622	199,78/pc.	11
718183	385,76/pc.	26	720525	158,91/m	17	723444	54,83/pc.	10	725623	250,87/pc.	11
718184	279,02/pc.	26	720526	223,37/m	17	723445	72,24/pc.	10	725624	272,50/pc.	11
718185	291,24/pc.	26	720527	202,01/pc.	18	723446	93,46/pc.	10	725625	298,79/pc.	11
718187	298,45/pc.	26	720528	224,14/pc.	18	723447	97,55/pc.	10	725636	56,36/pc.	19
718188	315,64/pc.	26	720529	39,98/pc.	19	723450	59,74/pc.	18	725751	37,07/pc.	20
718189	321,61/pc.	26	720530	190,48/pc.	20	723451	60,38/pc.	18	725760	52,95/pc.	21
718190	325,27/pc.	26	720531	29,30/pc.	20	723925	71,72/m	13	725763	10,96/pc.	11
718191	453,59/pc.	26	720536	142,12/pc.	19	723926	77,48/m	13	725774	52,95/pc.	22
718243	16,94/pc.	18	720761	17,97/pc.	13	723938	0,64/pc.	14	725775	58,33/pc.	22
718249	137,33/pc.	15	720762	18,75/pc.	13	723938	0,64/pc.	145	725776	45,69/pc.	29
718250	185,72/pc.	15	720763	20,53/pc.	13	723939	2,62/pc.	14	725777	54,89/pc.	29
718251	230,06/pc.	15	720764	23,72/pc.	13	724806	5,12/pc.	14	725785	12,95/pc.	30
718253	196,17/pc.	17	720765	31,66/pc.	13	724806	5,12/pc.	58	726433	99,55/pc.	13
718409	25,83/pc.	21	720766	36,49/pc.	13	724807	39,97/pc.	14	726434	102,24/pc.	13
718410	41,42/pc.	21	720815	95,88/pc.	28	725065	12,02/m	31	726435	152,71/pc.	13
718473	1,22/pc.	42	720816	108,27/pc.	28	725066	13,11/m	31	726436	207,31/pc.	13
718484	222,67/pc.	15	720824	25,88/pc.	22	725067	15,85/m	31	726437	322,81/pc.	13
718485	293,79/pc.	15	721101	10,67/pc.	17	725083	3,67/pc.	58	726438	349,26/pc.	13
718486	426,31/pc.	15	721102	12,03/m	15	725096	69,28/pc.	25	726484	104,90/pc.	19
718487	27,95/pc.	18	721105	10,99/pc.	22	725350	41,87/m	8	726485	109,76/pc.	19
718488	256,66/pc.	17	721106	12,67/pc.	22	725350	41,87/m	144	726668	1,08/pc.	22
718562	48,42/m	8	721114	73,80/pc.	23	725351	41,87/m	8	727125	73,67/pc.	10
718563	48,42/m	8	721115	6,64/pc.	20	725351	41,87/m	144	727126	77,64/pc.	10
718564	50,46/m	8	721119	13,01/pc.	19	725352	43,30/m	8	727127	85,55/pc.	10
718565	52,69/m	8	721122	16,99/pc.	21	725352	43,30/m	144	727128	91,75/pc.	10
718566	56,57/m	8	721862	45,11/pc.	13	725353	45,11/m	8	727195	108,22/pc.	25
718567	58,92/m	8	721863	45,61/pc.	13	725353	45,11/m	144	727197	122,36/pc.	23
718568	179,97/m	8	721864	51,54/pc.	13	725354	47,47/m	8	727340	96,90/pc.	23
718572	21,47/m	8	721865	53,38/pc.	13	725355	49,97/m	8	727346	577,68/pc.	24
718573	26,46/m	8	721866	58,91/pc.	13	725356	117,54/m	8	727347	606,55/pc.	24
718574	30,10/m	8	721867	61,60/pc.	13	725357	7,17/pc.	15	727348	681,73/pc.	24
718575	35,02/m	8	721869	13,41/pc.	13	725358	8,12/pc.	15	727349	762,45/pc.	24
718576	38,60/m	8	721870	18,28/pc.	13	725359	9,59/pc.	15	727350	808,76/pc.	24
718591	77,45/m	8	721871	19,58/pc.	13	725360	12,46/pc.	15	727351	866,62/pc.	24
718592	77,45/m	8	721872	25,96/pc.	13	725361	16,26/pc.	15	727352	1452,82/pc.	24
718593	80,76/m	8	721873	28,42/pc.	13	725362	11,15/pc.	18	727353	739,44/pc.	24
718594	84,32/m	8	721945	28,86/pc.	22	725363	16,20/pc.	22	727354	814,43/pc.	24
718595	90,54/m	8	721960	107,48/m	8	725557	71,43/pc.	14	727355	941,43/pc.	24
718596	94,60/m	8	721961	472,25/pc.	24	725558	79,24/pc.	14	727356	1352,69/pc.	24

Index

référence	prix en €	page	référence	prix en €	page	référence	prix en €	page	référence	prix en €	page
727357	939,58/pc.	24	731747	18,94/pc.	30	734495	41,79/m	8	781099	76,31/m	8
727358	831,76/pc.	25	731748	17,48/m	31	734496	44,74/m	8	781433	119,94/pc.	35
727359	751,03/pc.	25	731749	23,48/m	31	734497	48,56/m	8	781434	150,49/pc.	35
727360	843,39/pc.	25	731750	33,67/m	31	734498	51,25/m	8	781435	169,33/pc.	35
727361	947,33/pc.	25	731791	17,48/pc.	19	734713	85,43/pc.	21	781436	210,58/pc.	35
727362	1080,28/pc.	25	731792	34,62/pc.	19	735433	77,08/pc.	21	781437	223,66/pc.	35
727363	1299,79/pc.	25	731793	50,92/pc.	19	735434	86,27/pc.	21	781438	254,74/pc.	35
727370	542,85/pc.	26	731837	149,62/pc.	29	735435	94,94/pc.	21	781439	467,64/pc.	35
727371	485,25/pc.	26	731911	210,97/pc.	29	735436	106,51/pc.	21	781440	148,18/pc.	36
727372	582,29/pc.	26	731914	324,94/pc.	29	735446	3,60/pc.	22	781441	174,64/pc.	36
727373	612,29/pc.	26	731994	4,48/pc.	22	735977	12,35/m	43	781442	210,00/pc.	36
727374	644,67/pc.	26	732151	30,14/m	23	735978	15,04/m	43	781443	254,95/pc.	36
727375	658,56/pc.	26	732177	10,18/pc.	18	735979	19,76/m	43	781444	308,93/pc.	36
727376	344,75/m	9	732216	14,08/m	34	735980	24,44/m	43	781445	334,75/pc.	36
727377	350,06/m	9	732217	17,30/m	34	735981	34,15/m	43	781446	868,10/pc.	36
727378	366,50/m	9	732218	22,99/m	34	735982	43,46/m	43	781654	sur demande	36
727379	370,24/m	9	732219	33,63/m	34	735988	9,12/m	42	781751	155,31/pc.	35
727380	377,47/m	9	732220	39,08/m	34	735989	11,92/m	42	781752	178,43/pc.	35
727381	384,76/m	9	732221	53,83/m	34	735990	14,72/m	42	781753	224,43/pc.	35
727382	208,24/m	9	732222	133,26/m	34	735991	17,78/m	42	781754	295,77/pc.	35
727383	211,15/m	9	732264	34,92/m	34	735992	23,72/m	42	781755	336,21/pc.	35
727384	216,98/m	9	732265	36,02/m	34	735993	30,74/m	42	781756	394,04/pc.	35
727385	228,61/m	9	732266	45,73/m	34	735998	476,28/pc.	33	781757	806,54/pc.	35
727386	238,31/m	9	732267	58,71/m	34	736440	184,01/pc.	32	781765	208,62/pc.	36
727387	249,95/m	9	732268	59,79/m	34	736441	187,73/pc.	32	781766	245,65/pc.	36
727582	14,73/pc.	13	732269	71,69/m	34	736442	190,07/pc.	32	781767	360,79/pc.	36
727583	17,09/pc.	13	732270	158,47/m	34	736443	192,59/pc.	32	781768	365,55/pc.	36
727584	20,19/pc.	13	732291	111,98/m	34	736444	205,00/pc.	32	781769	474,88/pc.	36
727585	25,25/pc.	13	732292	143,67/m	34	736445	208,76/pc.	32	781770	519,90/pc.	36
727586	28,44/pc.	13	732293	180,15/m	34	736446	212,47/pc.	32	781771	1150,84/pc.	36
727777	39,96/pc.	10	732294	267,78/m	34	736447	233,37/pc.	32	781793	730,87/pc.	35
727778	43,64/pc.	10	732295	318,62/m	34	736448	237,11/pc.	32	781794	927,87/pc.	35
727779	48,66/pc.	10	732296	331,10/m	34	736449	240,74/pc.	32	781796	694,76/pc.	36
727780	54,03/pc.	10	732297	834,49/m	34	736450	275,26/pc.	32	781802	376,41/pc.	35
727781	55,55/pc.	10	732322	150,91/pc.	35	736451	279,02/pc.	32	781803	525,42/pc.	36
727782	151,65/pc.	10	732323	166,93/pc.	35	736452	282,72/pc.	32	782128	495,33/m	9
727783	171,70/pc.	10	732324	193,17/pc.	35	736453	314,93/pc.	32	782129	568,29/m	9
727784	175,69/pc.	10	732325	235,88/pc.	35	736454	318,57/pc.	32	782213	257,30/m	34
727785	177,55/pc.	10	732326	281,14/pc.	35	736455	321,01/pc.	32	782214	sur demande	34
728033	171,95/m	8	732327	304,50/pc.	35	736456	28,46/pc.	33	782365	94,27/m	34
728034	499,21/pc.	26	732328	396,97/pc.	35	736609	33,60/m	42	782366	81,84/m	34
728043	523,51/pc.	24	732345	169,00/pc.	36	736610	41,86/m	42	782367	109,85/m	34
728052	879,21/pc.	24	732346	205,75/pc.	36	736619	48,52/m	43	782368	134,41/m	34
728053	1198,08/pc.	24	732347	224,07/pc.	36	736620	59,33/m	43	782369	156,35/m	34
728586	9,20/pc.	35	732348	240,38/pc.	36	737198	10,83/pc.	33	782370	179,99/m	34
728595	202,34/m	16	732349	278,95/pc.	36	737704	30,21/pc.	33	782371	374,08/m	34
728642	13,91/pc.	32	732350	309,10/pc.	36	737705	30,21/pc.	33	782382	12,47/pc.	35
728643	26,58/pc.	32	732351	466,66/pc.	36	737706	30,21/pc.	33	782384	sur demande	35
728651	45,16/pc.	31	732475	257,98/pc.	31	737707	30,21/pc.	33	783155	21,47/m	8
728652	50,48/pc.	31	732476	267,35/pc.	31	737708	30,21/pc.	33	783156	26,46/m	8
728653	31,09/pc.	31	732477	304,50/pc.	31	739713	130,12/pc.	33	783157	30,10/m	8
728654	33,58/pc.	31	732478	325,37/pc.	31	760200	8,48/m	46	783158	35,02/m	8
728767	39,71/pc.	28	732479	332,38/pc.	31	762400	2,13/pc.	46	783159	38,60/m	8
728883	8,69/pc.	57	732481	993,29/pc.	31	768001	60,01/m	9	783374	47,08/pc.	22
729045	67,10/pc.	12	732482	1258,10/pc.	31	768002	60,01/m	9	783375	752,80/m	34
729217	6,62/pc.	35	732483	1307,87/pc.	31	768004	62,31/m	9	783376	sur demande	24
730188	8,63/pc.	35	732484	1790,00/pc.	31	768005	65,18/m	9	783377	sur demande	24
730190	18,56/pc.	35	732485	1821,06/pc.	31	768006	69,96/m	9	783460	22,09/pc.	30
730192	290,56/pc.	31	732983	22,31/pc.	30	768007	72,99/m	9	783461	28,42/pc.	30
730193	302,16/pc.	31	733258	1,47/pc.	43	768063	43,44/m	16	784066	444,76/m	10
730194	337,01/pc.	31	733487	11,90/pc.	18	768733	14,09/pc.	23	784067	463,05/m	10
730195	371,92/pc.	31	734171	46,07/pc.	21	768738	19,28/pc.	12	784068	487,94/m	10
730196	412,61/pc.	31	734172	56,47/pc.	21	780186	442,77/pc.	33	784069	507,41/m	10
730245	26,50/pc.	29	734173	69,28/pc.	21	780187	4945,44/set	33	784070	523,38/m	10
731717	26,80/m	16	734174	79,89/pc.	21	780452	39,35/pc.	34	784072	960,68/m	10
731719	31,54/m	16	734488	21,47/m	8	780453	41,18/pc.	34	784073	42,94/pc.	42
731721	26,80/m	16	734489	26,46/m	8	780454	44,90/pc.	34	784074	45,41/pc.	42
731724	49,57/m	16	734490	30,10/m	8	780455	46,81/pc.	34	784075	47,85/pc.	42
731727	202,34/m	16	734491	35,02/m	8	780456	50,55/pc.	34	784076	53,98/pc.	42
731745	28,42/pc.	29	734492	38,60/m	8	780457	52,42/pc.	34	784077	61,97/pc.	42
731746	31,59/pc.	29	734494	40,00/m	8	780874	146,37/pc.	21	784078	69,32/pc.	42

Index

référence	prix en €	page	référence	prix en €	page	référence	prix en €	page	référence	prix en €	page
784079	78,52/pc.	42	791414	7,61/pc.	56	795603	5,27/pc.	32	8605004	31,39/m	44
784080	98,78/pc.	42	791415	12,32/pc.	10	795604	5,49/pc.	32	8605204	29,90/m	44
784081	47,85/pc.	43	791415	12,32/pc.	56	795605	5,68/pc.	32	8605404	35,52/m	44
784082	50,30/pc.	43	791416	21,16/pc.	56	795606	5,93/pc.	32	8606204	36,23/m	44
784083	53,37/pc.	43	791417	26,27/pc.	56	795607	7,37/pc.	32	8750000	12,20/set	45
784084	62,57/pc.	43	791418	30,09/pc.	56	795608	8,12/pc.	32	8856050	1,21/pc.	47
784085	74,89/pc.	43	791419	46,58/pc.	56	795609	4,96/pc.	32	8890000	0,21/pc.	58
784086	79,14/pc.	43	792873	101,29/pc.	26	795610	5,13/pc.	32	8890100	0,59/pc.	58
784087	95,10/pc.	43	792875	sur demande	26	795611	5,49/pc.	32	8891000	0,18/pc.	58
784088	115,95/pc.	43	792877	44,52/pc.	27	795612	5,76/pc.	32	8900000	0,21/pc.	58
784089	47,24/pc.	42	792880	429,52/pc.	27	795613	6,38/pc.	32	8901000	0,08/pc.	58
784090	51,52/pc.	42	792881	431,06/pc.	27	795614	7,00/pc.	32	8940000	9,12/pc.	51
784091	53,37/pc.	42	792882	432,55/pc.	27	795615	8,43/pc.	32	8960000	14,06/pc.	51
784092	60,76/pc.	42	792883	434,54/pc.	27	795616	8,70/pc.	32	8980000	9,48/pc.	50
784093	69,32/pc.	42	792884	436,26/pc.	27	8010109	1,65/pc.	45	13020016	4,82/m	140
784094	77,30/pc.	42	792886	sur demande	27	8040000	63,93/pc.	47	13020020	6,11/m	140
784095	85,89/pc.	42	792888	171,72/pc.	28	8050000	5,00/m	58	13020025	7,95/m	140
784096	100,61/pc.	42	792893	15,84/pc.	12	8050100	5,00/m	58	13020032	10,97/m	140
784097	52,15/pc.	43	792903	1290,83/pc.	27	8050200	2,78/m	58	13020040	14,82/m	140
784098	55,82/pc.	43	792904	1351,57/pc.	27	8051000	4,21/m	58	13020050	18,34/m	140
784099	58,28/pc.	43	792905	1521,85/pc.	27	8051020	16,53/m	58	13020063	28,77/m	140
784100	65,66/pc.	43	792906	1675,87/pc.	27	8090109	6,90/pc.	47	13021016	18,27/m	141
784101	76,08/pc.	43	792907	1725,08/pc.	27	8101009	4,49/pc.	55	13021020	19,49/m	141
784102	81,59/pc.	43	792909	sur demande	27	8112009	5,44/pc.	55	13021025	24,06/m	141
784103	93,25/pc.	43	792920	1759,15/pc.	28	8123009	7,73/pc.	55	13021032	29,85/m	141
784104	118,40/pc.	43	792921	1915,30/pc.	28	8134009	8,74/pc.	55	13021040	38,31/m	141
786768	68,77/pc.	12	792922	2077,72/pc.	28	8135009	11,53/pc.	55	13021050	55,71/m	141
786768	68,77/pc.	144	792923	2077,72/pc.	28	8140709	7,62/pc.	55	13030016	4,65/m	136
787276	113,17/pc.	14	792924	2181,92/pc.	28	8141009	8,54/pc.	55	13030020	5,19/m	136
787276	113,17/pc.	56	794202	30,61/pc.	14	8141209	9,32/pc.	55	13030025	6,25/m	136
787277	169,36/pc.	14	794202	30,61/pc.	144	8141509	10,16/pc.	55	13030032	8,34/m	136
787278	482,54/pc.	14	794715	0,57/pc.	145	8142009	11,29/pc.	55	13030040	11,44/m	136
788164	20,92/pc.	17	795051	14,41/pc.	20	8142509	13,39/pc.	55	13030050	14,18/m	136
788165	30,01/pc.	17	795051	14,41/pc.	144	8143009	15,02/pc.	55	13030063	23,48/m	136
788572	5,70/pc.	42	795132	0,84/pc.	145	8143309	16,19/pc.	55	13030116	6,84/m	138
788573	6,75/pc.	43	795239	5,49/pc.	144	8161003	8,47/m	46	13030120	9,63/m	138
788638	113,25/pc.	26	795240	4,11/pc.	11	8161103	10,99/m	46	13030125	12,31/m	138
788639	175,26/pc.	36	795241	5,70/pc.	11	8161503	14,27/m	46	13030132	15,98/m	138
788640	194,53/pc.	36	795242	6,50/pc.	11	8162003	12,64/m	46	13030140	20,05/m	138
788641	257,65/pc.	36	795243	14,52/pc.	11	8163003	17,54/m	46	13030150	25,27/m	138
788642	470,01/pc.	36	795316	8,17/pc.	10	8164003	20,31/m	46	13030163	34,17/m	138
788643	494,30/pc.	36	795316	8,17/pc.	56	8164303	23,30/m	46	13040016	3,47/m	136
788644	656,03/pc.	36	795317	9,23/pc.	10	8165004	31,63/m	46	13040020	4,12/m	136
788645	1166,33/pc.	36	795317	9,23/pc.	56	8166004	34,10/m	46	13040025	5,11/m	136
788646	2388,97/pc.	36	795318	13,51/pc.	10	8167004	39,62/m	46	13040032	7,93/m	136
788647	244,62/pc.	36	795318	13,51/pc.	56	8168004	54,58/m	46	13040040	10,30/m	136
788648	301,85/pc.	36	795319	15,34/pc.	10	8180000	0,15/pc.	58	13040050	13,27/m	136
788649	369,39/pc.	36	795319	15,34/pc.	56	8190000	0,05/pc.	58	13040063	17,08/m	136
788650	673,93/pc.	36	795320	20,90/pc.	10	8190020	0,21/pc.	58	13040116	5,18/m	138
788651	1150,67/pc.	36	795320	20,90/pc.	56	8250109	6,37/pc.	47	13040120	5,94/m	138
788652	1167,21/pc.	36	795321	23,59/pc.	10	8250209	7,49/pc.	47	13040125	7,70/m	138
788653	2426,57/pc.	36	795321	23,59/pc.	56	8461000	0,21/pc.	58	13040132	10,04/m	138
789875	2,87/pc.	23	795322	19,16/pc.	10	8461020	0,26/pc.	58	13040140	12,01/m	138
789876	7,42/pc.	23	795322	19,16/pc.	56	8462000	0,23/pc.	58	13040150	16,76/m	138
790906	76,34/pc.	25	795323	21,76/pc.	10	8462020	0,25/pc.	58	13040163	26,04/m	138
791063	20,77/pc.	13	795323	21,76/pc.	56	8601004	13,70/m	44	30060702	10,54/pc.	48
791064	21,23/pc.	13	795363	51,65/pc.	56	8601202	11,15/m	44	30061002	11,55/pc.	48
791065	21,68/pc.	13	795364	56,19/pc.	56	8601204	13,05/m	44	30061202	12,64/pc.	48
791066	22,39/pc.	13	795588	6,57/pc.	37	8601404	13,05/m	44	30061502	15,04/pc.	48
791067	23,23/pc.	13	795589	6,70/pc.	37	8602004	16,26/m	44	30062002	15,71/pc.	48
791068	23,66/pc.	13	795590	8,85/pc.	37	8602202	12,48/m	44	30062502	18,47/pc.	48
791092	4,10/pc.	13	795591	9,60/pc.	37	8602204	15,52/m	44	30063002	25,65/pc.	48
791199	17,21/pc.	20	795592	66,08/pc.	37	8602404	15,52/m	44	30063302	26,45/pc.	48
791200	42,19/pc.	20	795593	70,13/pc.	37	8603004	21,12/m	44	30064002	34,35/pc.	48
791350	50,00/pc.	26	795594	6,47/pc.	37	8603202	16,71/m	44	30065002	47,96/pc.	48
791401	83,99/pc.	26	795595	6,65/pc.	37	8603204	20,10/m	44	30066002	69,57/pc.	48
791412	4,50/pc.	10	795596	71,52/pc.	37	8603404	20,10/m	44	30070702	8,21/pc.	50
791412	4,50/pc.	56	795598	6,84/pc.	35	8604004	25,30/m	44	30071002	8,74/pc.	50
791413	6,27/pc.	10	795600	4,47/pc.	32	8604202	18,79/m	44	30071202	10,37/pc.	50
791413	6,27/pc.	56	795601	4,83/pc.	32	8604204	24,09/m	44	30071502	11,97/pc.	50
791414	7,61/pc.	10	795602	4,89/pc.	32	8604404	24,09/m	44	30072002	13,45/pc.	50

Index

référence	prix en €	page	référence	prix en €	page	référence	prix en €	page	référence	prix en €	page
30072502	16,00/pc.	50	36071202	19,98/pc.	50	36243002	100,89/pc.	53	55003016	13,45/pc.	141
30073002	17,33/pc.	50	36071502	20,43/pc.	50	36243302	112,92/pc.	53	55003020	16,33/pc.	141
30073302	20,40/pc.	50	36072002	22,14/pc.	50	36244002	123,61/pc.	53	55003025	17,88/pc.	141
30074002	23,61/pc.	50	36072502	25,27/pc.	50	36245002	167,50/pc.	53	55003032	19,42/pc.	141
30075002	26,84/pc.	50	36073002	36,15/pc.	50	36246002	205,20/pc.	53	55003040	27,19/pc.	141
30076002	33,10/pc.	50	36073302	43,01/pc.	50	36252202	22,57/pc.	51	55003050	58,26/pc.	141
30150702	14,13/pc.	49	36074002	49,91/pc.	50	36252402	29,68/pc.	51	55004016	1,85/pc.	136
30151002	15,06/pc.	49	36075002	65,11/pc.	50	36252602	30,71/pc.	51	55004020	1,96/pc.	136
30151202	16,52/pc.	49	36076002	65,43/pc.	50	36254702	31,50/pc.	51	55004025	2,19/pc.	136
30151502	16,93/pc.	49	36110002	7,94/pc.	50	36254802	41,43/pc.	51	55004032	3,06/pc.	136
30152002	19,01/pc.	49	36150702	34,69/pc.	49	36256402	45,25/pc.	51	55004040	3,81/pc.	136
30152502	21,36/pc.	49	36151002	37,59/pc.	49	36430702	40,75/pc.	52	55004050	6,20/pc.	136
30153002	24,59/pc.	49	36151202	39,68/pc.	49	36431002	41,55/pc.	52	55004063	10,46/pc.	136
30153302	26,98/pc.	49	36151502	41,79/pc.	49	36431202	42,08/pc.	52	55004116	2,41/pc.	139
30154002	32,52/pc.	49	36152002	45,69/pc.	49	36431502	51,47/pc.	52	55004120	2,75/pc.	139
30155002	63,51/pc.	49	36152502	54,20/pc.	49	36432002	52,56/pc.	52	55004125	3,81/pc.	139
30156002	77,56/pc.	49	36153002	62,70/pc.	49	36432502	56,60/pc.	52	55004132	5,06/pc.	139
30160702	23,59/pc.	50	36153302	70,08/pc.	49	36433002	57,03/pc.	52	55004140	6,87/pc.	139
30161002	25,55/pc.	50	36154002	87,39/pc.	49	36433302	57,59/pc.	52	55004150	10,53/pc.	139
30161202	26,84/pc.	50	36155002	98,66/pc.	49	36434002	62,84/pc.	52	55004163	14,39/pc.	139
30161502	27,90/pc.	50	36156002	120,06/pc.	49	36435002	68,77/pc.	52	55005016	1,92/pc.	137
30162002	30,63/pc.	50	36160702	54,41/pc.	49	36436002	71,73/pc.	52	55005020	2,23/pc.	137
30162502	33,97/pc.	50	36161002	55,38/pc.	49	36510702	15,68/pc.	51	55005025	2,75/pc.	137
30163002	38,22/pc.	50	36161202	56,02/pc.	49	36511002	16,43/pc.	51	55005032	3,63/pc.	137
30163302	41,42/pc.	50	36161502	56,93/pc.	49	36511202	16,91/pc.	51	55005040	5,32/pc.	137
30164002	48,95/pc.	50	36162002	59,05/pc.	49	36511502	17,55/pc.	51	55005050	6,38/pc.	137
30165002	58,77/pc.	50	36162502	69,12/pc.	49	36512002	18,78/pc.	51	55005063	11,48/pc.	137
30166002	70,52/pc.	50	36163002	76,19/pc.	49	36512502	21,53/pc.	51	55006016	1,92/pc.	136
30220702	10,54/pc.	52	36163302	100,07/pc.	49	36513002	23,29/pc.	51	55006020	2,00/pc.	136
30221002	11,30/pc.	52	36164002	113,80/pc.	49	36513302	25,18/pc.	51	55006025	2,46/pc.	136
30221202	12,25/pc.	52	36165002	134,14/pc.	49	36514002	30,56/pc.	51	55006032	3,09/pc.	136
30221502	13,72/pc.	52	36166002	164,39/pc.	49	36520702	26,54/pc.	48	55006040	4,60/pc.	136
30222002	15,71/pc.	52	36180704	6,13/pc.	53	36521002	29,30/pc.	48	55006050	6,42/pc.	136
30222502	19,84/pc.	52	36181004	6,45/pc.	53	36521202	30,01/pc.	48	55006063	11,29/pc.	136
30223002	22,27/pc.	52	36181204	6,89/pc.	53	36521502	31,03/pc.	48	55006116	2,00/pc.	139
30223302	24,59/pc.	52	36181504	7,39/pc.	53	36522002	32,46/pc.	48	55006120	2,27/pc.	139
30224002	31,03/pc.	52	36182004	7,70/pc.	53	36522502	36,45/pc.	48	55006125	2,91/pc.	139
30225002	37,08/pc.	52	36182504	8,29/pc.	53	36523002	38,32/pc.	48	55006132	4,01/pc.	139
30226002	47,65/pc.	52	36183004	9,42/pc.	53	36523302	57,04/pc.	48	55006140	6,34/pc.	139
30230702	10,54/pc.	52	36183304	10,10/pc.	53	36524002	100,71/pc.	48	55006150	8,50/pc.	139
30231002	11,07/pc.	52	36184004	10,94/pc.	53	36525002	142,00/pc.	48	55006163	12,80/pc.	139
30231202	12,25/pc.	52	36185004	13,04/pc.	53	36526002	166,04/pc.	48	55007016	2,37/pc.	137
30231502	14,26/pc.	52	36186004	15,20/pc.	53	37031160	3,16/pc.	137	55007020	2,63/pc.	137
30232002	15,71/pc.	52	36220702	20,15/pc.	52	37031201	3,88/pc.	137	55007025	2,77/pc.	137
30232502	19,84/pc.	52	36221002	22,14/pc.	52	37031250	5,15/pc.	137	55007032	3,67/pc.	137
30233002	23,59/pc.	52	36221202	24,33/pc.	52	37031320	9,46/pc.	137	55007040	4,21/pc.	137
30233302	24,59/pc.	52	36221502	26,49/pc.	52	37031400	13,99/pc.	137	55007050	5,36/pc.	137
30234002	31,03/pc.	52	36222002	29,16/pc.	52	37031500	25,57/pc.	137	55007063	8,46/pc.	137
30235002	37,08/pc.	52	36222502	36,86/pc.	52	37031630	48,09/pc.	137	55012016	13,35/pc.	140
30236002	47,65/pc.	52	36223002	46,50/pc.	52	39095000	1,92/pc.	137	55012020	14,60/pc.	140
30252202	10,01/pc.	51	36223302	51,18/pc.	52	39095100	2,27/pc.	137	55012025	15,82/pc.	140
30252402	11,44/pc.	51	36224002	62,00/pc.	52	39095200	2,34/pc.	137	55012032	19,03/pc.	140
30252602	14,35/pc.	51	36225002	74,92/pc.	52	39095400	2,68/pc.	137	55012040	21,79/pc.	140
30254702	12,96/pc.	51	36226002	81,17/pc.	52	39095500	2,84/pc.	137	55012050	26,11/pc.	140
30254802	16,86/pc.	51	36230702	20,15/pc.	51	39095600	3,25/pc.	137	55012063	33,80/pc.	140
30256402	17,22/pc.	51	36231002	22,14/pc.	51	39095700	3,85/pc.	137	55013016	40,42/pc.	141
33105001	90,22/pc.	262	36231202	24,33/pc.	51	39095800	4,87/pc.	137	55013020	42,91/pc.	141
33105002	157,47/pc.	262	36231502	26,49/pc.	51	40011160	0,40/pc.	137	55013025	46,61/pc.	141
36060702	25,80/pc.	48	36232002	29,16/pc.	51	40011200	0,54/pc.	137	55013032	62,14/pc.	141
36061002	27,14/pc.	48	36232502	36,86/pc.	51	40011250	0,83/pc.	137	55013040	80,81/pc.	141
36061202	27,73/pc.	48	36233002	46,50/pc.	51	40011320	1,12/pc.	137	55013050	123,68/pc.	141
36061502	28,65/pc.	48	36233302	51,18/pc.	51	40011400	1,87/pc.	137	55014016	7,26/pc.	136
36062002	30,76/pc.	48	36234002	62,00/pc.	51	40011500	3,45/pc.	137	55014020	7,52/pc.	136
36062502	37,63/pc.	48	36235002	74,92/pc.	51	40011630	5,75/pc.	137	55014025	8,02/pc.	136
36063002	45,52/pc.	48	36236002	81,17/pc.	51	55002016	2,88/pc.	140	55014032	11,65/pc.	136
36063302	49,50/pc.	48	36240702	67,15/pc.	53	55002020	3,38/pc.	140	55014040	17,45/pc.	136
36064002	58,80/pc.	48	36241002	67,49/pc.	53	55002025	4,03/pc.	140	55014050	32,84/pc.	136
36065002	74,31/pc.	48	36241202	70,31/pc.	53	55002032	4,96/pc.	140	55014063	51,18/pc.	136
36066002	94,71/pc.	48	36241502	73,02/pc.	53	55002040	6,11/pc.	140	55014116	11,19/pc.	139
36070702	18,35/pc.	50	36242002	76,57/pc.	53	55002050	9,64/pc.	140	55014120	12,63/pc.	139
36071002	19,54/pc.	50	36242502	88,16/pc.	53	55002063	11,76/pc.	140	55014125	14,07/pc.	139

Index

référence	prix en €	page	référence	prix en €	page	référence	prix en €	page	référence	prix en €	page
55014132	18,67/pc.	139	55080050	31,69/pc.	138	60252060	38,70/m	98	60613315	25,14/m	112
55014140	27,04/pc.	139	55081016	9,46/pc.	138	60252065	50,97/m	93	60613320	29,88/m	112
55014150	47,25/pc.	139	55081020	10,86/pc.	138	60252100	52,71/m	98	60623206	16,89/m	112
55014163	64,85/pc.	139	55081025	11,87/pc.	138	60252150	62,44/m	98	60623306	19,78/m	112
55015016	4,39/pc.	136	55081032	14,96/pc.	138	60252200	71,90/m	98	60623310	24,68/m	112
55015020	5,00/pc.	136	55081040	21,79/pc.	138	60252300	90,88/m	98	60623315	26,86/m	112
55015025	5,22/pc.	136	55081050	32,01/pc.	138	60252400	113,62/m	98	60623320	31,85/m	112
55015032	7,74/pc.	136	55111016	1,29/pc.	137	60252500	134,42/m	98	60633206	24,20/m	112
55015040	12,34/pc.	136	55111020	1,37/pc.	137	60252600	152,75/m	98	60633306	29,51/m	112
55015050	21,91/pc.	136	55111025	1,55/pc.	137	60253100	66,19/m	98	60633310	34,81/m	112
55015063	30,68/pc.	136	55111032	2,20/pc.	137	60253150	74,58/m	98	60633315	37,14/m	112
55015116	9,46/pc.	139	55111040	2,52/pc.	137	60253200	94,39/m	98	60633320	45,67/m	112
55015120	9,61/pc.	139	55111050	3,02/pc.	137	60253300	113,77/m	98	60683206	21,30/m	112
55015125	10,54/pc.	139	55111063	3,52/pc.	137	60253400	133,57/m	98	60683306	25,97/m	112
55015132	15,03/pc.	139	60211060	9,42/m	97	60253500	155,05/m	98	60683310	30,63/m	112
55015140	24,14/pc.	139	60211100	9,71/m	97	60253600	173,69/m	98	60683315	32,64/m	112
55015150	34,71/pc.	139	60211150	13,64/m	97	60281060	10,30/m	97	60683320	40,20/m	112
55015163	49,77/pc.	139	60211200	14,92/m	97	60281100	11,40/m	97	62011060	3,24/pc.	108
55022016	1,78/pc.	140	60211300	21,41/m	97	60281150	14,72/m	97	62016020	7,57/pc.	107
55022020	1,92/pc.	140	60211400	26,84/m	97	60281200	16,74/m	97	62016021	1,89/pc.	107
55022025	2,03/pc.	140	60212065	9,39/m	93	60281300	23,15/m	97	62016022	6,24/pc.	108
55022032	2,30/pc.	140	60215020	16,90/m	112	60281400	27,55/m	97	62021060	3,24/pc.	108
55022040	2,72/pc.	140	60220000	13,90/m	113	60282065	13,72/m	93	62021104	6,52/pc.	86
55031016	2,68/pc.	140	60221060	9,76/m	97	60512060	9,28/m	95	62021104	6,52/pc.	114
55031020	2,79/pc.	140	60221100	10,06/m	97	60512100	11,75/m	95	62021104	6,52/pc.	147
55031025	2,91/pc.	140	60221150	14,13/m	97	60512150	14,39/m	95	62021104	6,52/pc.	150
55031032	2,98/pc.	140	60221200	15,45/m	97	60512200	16,20/m	95	62021154	8,42/pc.	86
55031040	3,40/pc.	140	60221300	22,18/m	97	60512300	21,00/m	95	62021154	8,42/pc.	114
55032116	2,19/pc.	139	60221400	27,82/m	97	60512400	30,06/m	95	62021154	8,42/pc.	147
55032120	2,23/pc.	139	60222065	10,42/m	93	60512500	37,03/m	95	62021154	8,42/pc.	150
55032125	2,38/pc.	139	60222100	sur demande	146	60512600	43,77/m	95	62021204	9,65/pc.	86
55032132	2,75/pc.	139	60222150	sur demande	146	60513100	22,38/m	96	62021204	9,65/pc.	114
55032140	3,70/pc.	139	60222200	sur demande	146	60513150	27,39/m	96	62021204	9,65/pc.	147
55032150	5,06/pc.	139	60222300	sur demande	146	60513200	29,71/m	96	62021204	9,65/pc.	150
55032163	8,50/pc.	139	60222400	sur demande	146	60513300	35,71/m	96	62021304	11,38/pc.	86
55033116	2,38/pc.	139	60225020	17,51/m	112	60513400	46,49/m	96	62021304	11,38/pc.	114
55033120	2,46/pc.	139	60230000	17,22/m	113	60513500	55,25/m	96	62021304	11,38/pc.	147
55033125	2,64/pc.	139	60231060	11,70/m	97	60513600	56,22/m	96	62021304	11,38/pc.	150
55033132	3,02/pc.	139	60231100	12,94/m	97	60522060	10,12/m	95	62021404	17,01/pc.	86
55033140	4,08/pc.	139	60231150	16,74/m	97	60522100	13,02/m	95	62021404	17,01/pc.	114
55033150	5,59/pc.	139	60231200	19,01/m	97	60522150	15,95/m	95	62021404	17,01/pc.	147
55033163	9,36/pc.	139	60231300	26,32/m	97	60522200	17,98/m	95	62021404	17,01/pc.	150
55034016	5,47/pc.	141	60231400	31,30/m	97	60522300	23,22/m	95	62021504	19,45/pc.	86
55034020	6,23/pc.	141	60232060	13,25/m	98	60522400	33,13/m	95	62021504	19,45/pc.	117
55034025	7,41/pc.	141	60232065	15,56/m	93	60522500	41,07/m	95	62021604	23,20/pc.	86
55034032	10,50/pc.	141	60232100	17,92/m	98	60522600	48,33/m	95	62021604	23,20/pc.	117
55034040	12,84/pc.	141	60232100	17,92/m	146	60523100	22,90/m	96	62022104	12,87/pc.	86
55034050	14,79/pc.	141	60232150	22,18/m	98	60523150	28,00/m	96	62022104	12,87/pc.	114
55035016	7,77/pc.	141	60232150	22,18/m	146	60523200	30,49/m	96	62022104	12,87/pc.	147
55035020	10,11/pc.	141	60232200	26,26/m	98	60523300	36,49/m	96	62022154	13,52/pc.	86
55035025	13,23/pc.	141	60232200	26,26/m	146	60523400	47,51/m	96	62022154	13,52/pc.	114
55035032	17,88/pc.	141	60232300	35,92/m	98	60523500	57,31/m	96	62022154	13,52/pc.	147
55035040	21,00/pc.	141	60232300	35,92/m	146	60523600	58,37/m	96	62022204	14,54/pc.	86
55035050	27,19/pc.	141	60232400	47,44/m	98	60582060	13,72/m	95	62022204	14,54/pc.	114
55070016	8,53/pc.	138	60232400	47,44/m	146	60582100	15,81/m	95	62022204	14,54/pc.	147
55070020	9,21/pc.	138	60232500	55,94/m	98	60582150	19,53/m	95	62022304	17,01/pc.	86
55070025	9,82/pc.	138	60232600	66,02/m	98	60582200	23,12/m	95	62022304	17,01/pc.	114
55070032	13,06/pc.	138	60233100	28,26/m	98	60582300	31,60/m	95	62022304	17,01/pc.	147
55070040	18,45/pc.	138	60233150	31,41/m	98	60582400	41,74/m	95	62022404	25,10/pc.	86
55070050	25,43/pc.	138	60233200	41,06/m	98	60582500	49,22/m	95	62022404	25,10/pc.	114
55071016	8,10/pc.	138	60233300	52,25/m	98	60582600	58,09/m	95	62022404	25,10/pc.	147
55071020	9,13/pc.	138	60233400	63,75/m	98	60583100	25,16/m	96	62025103	8,14/pc.	85
55071025	9,75/pc.	138	60233500	74,37/m	98	60583150	28,50/m	96	62025103	8,14/pc.	115
55071032	12,41/pc.	138	60233600	79,41/m	98	60583200	35,82/m	96	62025103	8,14/pc.	148
55071040	17,95/pc.	138	60250000	32,08/m	113	60583300	46,12/m	96	62025103	8,14/pc.	151
55071050	25,17/pc.	138	60251060	32,18/m	97	60583400	56,49/m	96	62025153	9,50/pc.	85
55080016	9,57/pc.	138	60251100	38,34/m	97	60583500	73,17/m	96	62025153	9,50/pc.	115
55080020	10,50/pc.	138	60251150	45,64/m	97	60583600	79,41/m	96	62025153	9,50/pc.	148
55080025	11,98/pc.	138	60251200	59,07/m	97	60613206	15,83/m	112	62025153	9,50/pc.	151
55080032	15,10/pc.	138	60251300	78,10/m	97	60613306	18,54/m	112	62025203	10,93/pc.	85
55080040	21,62/pc.	138	60251400	117,09/m	97	60613310	23,12/m	112	62025203	10,93/pc.	115

Index

référence	prix en €	page	référence	prix en €	page	référence	prix en €	page	référence	prix en €	page
62025203	10,93/pc.	148	62035153	14,06/pc.	148	62081154	12,76/pc.	114	62310201	14,77/pc.	124
62025203	10,93/pc.	151	62035153	14,06/pc.	151	62081204	13,68/pc.	114	63022104	4,41/pc.	87
62025303	12,51/pc.	85	62035203	16,61/pc.	85	62081304	14,63/pc.	114	63022104	4,41/pc.	116
62025303	12,51/pc.	115	62035203	16,61/pc.	115	62081404	22,57/pc.	114	63022104	4,41/pc.	150
62025303	12,51/pc.	148	62035203	16,61/pc.	148	62081504	26,18/pc.	117	63022154	4,87/pc.	87
62025303	12,51/pc.	151	62035203	16,61/pc.	151	62081604	31,34/pc.	117	63022154	4,87/pc.	116
62025403	18,07/pc.	85	62035303	20,56/pc.	85	62082104	17,01/pc.	114	63022154	4,87/pc.	150
62025403	18,07/pc.	115	62035303	20,56/pc.	115	62082154	18,71/pc.	114	63022204	6,11/pc.	87
62025403	18,07/pc.	148	62035303	20,56/pc.	148	62082204	20,89/pc.	114	63022204	6,11/pc.	116
62025403	18,07/pc.	151	62035303	20,56/pc.	151	62082304	25,03/pc.	114	63022204	6,11/pc.	150
62025503	20,97/pc.	85	62035403	23,00/pc.	85	62082404	38,27/pc.	114	63022304	7,19/pc.	87
62025503	20,97/pc.	115	62035403	23,00/pc.	115	62085103	12,58/pc.	115	63022304	7,19/pc.	116
62025603	23,86/pc.	85	62035403	23,00/pc.	148	62085153	14,06/pc.	115	63022304	7,19/pc.	150
62025603	23,86/pc.	115	62035403	23,00/pc.	151	62085203	16,61/pc.	115	63022404	9,72/pc.	87
62026010	3,39/pc.	105	62035503	28,68/pc.	85	62085303	20,56/pc.	115	63022404	9,72/pc.	116
62026011	6,31/pc.	106	62035503	28,68/pc.	115	62085403	23,00/pc.	115	63022404	9,72/pc.	150
62026020	7,57/pc.	107	62035603	33,37/pc.	85	62085503	28,68/pc.	115	63022504	10,95/pc.	87
62026021	1,89/pc.	107	62035603	33,37/pc.	115	62085603	33,37/pc.	115	63022504	10,95/pc.	116
62026022	6,24/pc.	108	62036010	7,27/pc.	105	62086010	7,27/pc.	105	63022604	14,47/pc.	87
62031060	4,35/pc.	108	62036011	11,09/pc.	106	62086011	11,09/pc.	106	63022604	14,47/pc.	116
62031084	1,03/pc.	116	62036020	11,27/pc.	107	62086020	11,27/pc.	107	63032104	7,33/pc.	87
62031085	0,51/pc.	117	62036021	3,15/pc.	107	62086021	3,15/pc.	107	63032104	7,33/pc.	116
62031090	6,44/pc.	147	62036022	8,31/pc.	108	62086022	8,31/pc.	108	63032104	7,33/pc.	150
62031090	6,44/pc.	150	62037002	20,23/pc.	85	62301100	4,52/pc.	123	63032154	7,84/pc.	87
62031104	9,98/pc.	86	62037002	20,23/pc.	115	62301400	5,10/pc.	123	63032154	7,84/pc.	116
62031104	9,98/pc.	114	62051104	20,62/pc.	86	62301800	9,31/pc.	123	63032154	7,84/pc.	150
62031104	9,98/pc.	147	62051104	20,62/pc.	114	62302102	0,48/m	123	63032204	9,59/pc.	87
62031104	9,98/pc.	150	62051154	25,58/pc.	86	62302401	0,55/m	123	63032204	9,59/pc.	116
62031154	12,76/pc.	86	62051154	25,58/pc.	114	62302801	0,84/m	123	63032204	9,59/pc.	150
62031154	12,76/pc.	114	62051204	32,18/pc.	86	62303101	7,23/pc.	123	63032304	11,51/pc.	87
62031154	12,76/pc.	147	62051204	32,18/pc.	114	62303103	9,20/pc.	123	63032304	11,51/pc.	116
62031154	12,76/pc.	150	62051304	39,00/pc.	86	62303105	11,18/pc.	123	63032304	11,51/pc.	150
62031204	13,68/pc.	86	62051304	39,00/pc.	114	62303301	8,79/pc.	123	63032404	13,98/pc.	87
62031204	13,68/pc.	114	62051404	47,44/pc.	86	62303303	11,08/pc.	123	63032404	13,98/pc.	116
62031204	13,68/pc.	147	62051404	47,44/pc.	114	62303305	13,26/pc.	123	63032404	13,98/pc.	150
62031204	13,68/pc.	150	62051504	54,81/pc.	86	62303601	20,44/pc.	123	63032504	16,50/pc.	87
62031304	14,63/pc.	86	62051504	54,81/pc.	117	62303603	23,04/pc.	123	63032504	16,50/pc.	116
62031304	14,63/pc.	114	62051604	62,38/pc.	86	62303605	25,58/pc.	123	63032604	19,75/pc.	87
62031304	14,63/pc.	147	62051604	62,38/pc.	117	62304101	8,27/pc.	123	63032604	19,75/pc.	116
62031304	14,63/pc.	150	62052104	35,19/pc.	86	62304103	9,36/pc.	123	63052104	14,02/pc.	87
62031404	22,57/pc.	86	62052104	35,19/pc.	114	62304105	15,50/pc.	123	63052104	14,02/pc.	116
62031404	22,57/pc.	114	62052154	38,17/pc.	86	62304301	10,40/pc.	123	63052154	16,93/pc.	87
62031404	22,57/pc.	147	62052154	38,17/pc.	114	62304303	11,65/pc.	123	63052154	16,93/pc.	116
62031404	22,57/pc.	150	62052204	50,18/pc.	86	62304305	13,57/pc.	123	63052204	19,63/pc.	87
62031504	26,18/pc.	86	62052204	50,18/pc.	114	62304601	14,61/pc.	123	63052204	19,63/pc.	116
62031504	26,18/pc.	117	62052304	57,65/pc.	86	62304603	16,33/pc.	123	63052304	24,52/pc.	87
62031604	31,34/pc.	86	62052304	57,65/pc.	114	62304605	22,05/pc.	123	63052304	24,52/pc.	116
62031604	31,34/pc.	117	62052404	66,63/pc.	86	62305430	6,92/pc.	123	63052404	31,19/pc.	87
62032104	17,01/pc.	86	62052404	66,63/pc.	114	62305440	7,18/pc.	123	63052404	31,19/pc.	116
62032104	17,01/pc.	114	62055103	28,30/pc.	85	62306230	6,29/pc.	124	63052504	38,09/pc.	87
62032104	17,01/pc.	147	62055103	28,30/pc.	115	62306240	6,55/pc.	124	63052504	38,09/pc.	116
62032154	18,71/pc.	86	62055153	31,20/pc.	85	62306250	6,71/pc.	124	63052604	46,21/pc.	87
62032154	18,71/pc.	114	62055153	31,20/pc.	115	62307231	15,03/pc.	123	63052604	46,21/pc.	116
62032154	18,71/pc.	147	62055203	34,90/pc.	85	62307233	16,33/pc.	123	63082104	9,34/pc.	116
62032204	20,89/pc.	86	62055203	34,90/pc.	115	62307241	15,08/pc.	123	63082154	9,48/pc.	116
62032204	20,89/pc.	114	62055303	42,37/pc.	85	62307243	16,38/pc.	123	63082204	9,59/pc.	116
62032204	20,89/pc.	147	62055303	42,37/pc.	115	62307631	23,09/pc.	123	63082304	11,51/pc.	116
62032304	25,03/pc.	86	62055403	70,99/pc.	85	62307633	24,54/pc.	123	63082404	13,98/pc.	116
62032304	25,03/pc.	114	62055403	70,99/pc.	115	62307641	23,45/pc.	123	63082504	16,50/pc.	116
62032304	25,03/pc.	147	62055503	80,11/pc.	85	62307643	24,96/pc.	123	63082604	19,75/pc.	116
62032404	38,27/pc.	86	62055503	80,11/pc.	115	62308231	13,68/pc.	124	64010020	4,28/pc.	100
62032404	38,27/pc.	114	62055603	91,02/pc.	85	62308233	14,77/pc.	124	64010035	2,40/pc.	99
62032404	38,27/pc.	147	62057002	sur demande	85	62308241	13,57/pc.	124	64010036	3,43/pc.	100
62035001	6,44/pc.	148	62057002	sur demande	115	62308243	14,82/pc.	124	64010038	2,71/pc.	95
62035001	6,44/pc.	151	62061060	7,79/pc.	108	62308631	19,40/pc.	124	64010040	2,71/pc.	95
62035103	12,58/pc.	85	62066010	12,87/pc.	105	62308633	21,32/pc.	124	64010041	1,52/pc.	100
62035103	12,58/pc.	115	62066011	12,87/pc.	106	62308641	19,60/pc.	124	64010046	4,07/pc.	96
62035103	12,58/pc.	148	62066022	16,38/pc.	108	62308643	21,48/pc.	124	64010048	4,07/pc.	96
62035103	12,58/pc.	151	62081060	4,35/pc.	108	62309501	72,23/pc.	124	64010058	0,75/pc.	93
62035153	14,06/pc.	85	62081104	9,98/pc.	114	62309502	83,67/pc.	124	64010059	0,21/pc.	62
62035153	14,06/pc.	115				62309503	95,11/pc.	124	64010059	0,21/pc.	118

Index

référence	prix en €	page	référence	prix en €	page	référence	prix en €	page	référence	prix en €	page
64010060	1,18/pc.	102	67010100	0,30/pc.	62	67020158	2,06/pc.	133	67030205	5,60/pc.	127
64010061	1,61/pc.	99	67010100	0,30/pc.	118	67020158	2,06/pc.	148	67030206	7,52/pc.	129
64010062	0,64/pc.	102	67010140	3,04/pc.	88	67020159	3,15/pc.	133	67030207	15,76/pc.	128
64010072	1,46/pc.	102	67010141	3,90/m	88	67020240	5,51/pc.	107	67030208	6,80/pc.	129
64020030	4,28/pc.	100	67010143	4,02/pc.	109	67020340	5,51/pc.	107	67030209	4,39/pc.	128
64020035	2,40/pc.	99	67010144	1,56/pc.	109	67020440	5,51/pc.	107	67030210	4,39/pc.	128
64020036	3,43/pc.	100	67010240	5,22/pc.	107	67020520	8,11/pc.	85	67030211	5,92/pc.	128
64020038	3,00/pc.	95	67010340	5,22/pc.	107	67020520	8,11/pc.	110	67030212	7,11/pc.	128
64020040	3,00/pc.	95	67010440	5,22/pc.	107	67020522	9,70/pc.	85	67030213	15,76/pc.	128
64020041	1,52/pc.	100	67011058	1,48/pc.	132	67020522	9,70/pc.	110	67030214	18,24/pc.	127
64020046	4,43/pc.	96	67020010	1,73/pc.	119	67020524	11,15/pc.	85	67030215	6,17/pc.	129
64020048	4,43/pc.	96	67020013	0,21/pc.	119	67020524	11,15/pc.	110	67030216	13,04/pc.	129
64020058	0,81/pc.	93	67020014	0,30/pc.	119	67020610	7,24/m	64	67030252	2,82/pc.	113
64020059	0,21/pc.	118	67020014	0,30/pc.	147	67020610	7,24/m	103	67030520	10,06/pc.	85
64020060	1,18/pc.	102	67020014	0,30/pc.	149	67020611	8,14/m	64	67030520	10,06/pc.	110
64020060	1,18/pc.	146	67020020	5,26/pc.	117	67020611	8,14/m	104	67030522	12,79/pc.	85
64020061	1,61/pc.	99	67020030	8,91/pc.	105	67020612	14,31/m	64	67030522	12,79/pc.	110
64020061	1,61/pc.	146	67020039	4,37/pc.	106	67020612	14,31/m	104	67030524	15,39/pc.	85
64020062	0,64/pc.	102	67020040	4,99/pc.	106	67030010	2,58/pc.	119	67030524	15,39/pc.	110
64020072	1,46/pc.	102	67020041	14,03/pc.	113	67030013	0,31/pc.	119	67030539	8,37/pc.	110
64030030	5,11/pc.	100	67020043	4,02/pc.	109	67030014	0,80/pc.	119	67030540	10,52/pc.	110
64030035	3,37/pc.	99	67020044	5,42/pc.	120	67030016	13,46/pc.	106	67030541	14,84/pc.	110
64030036	4,80/pc.	100	67020044	5,42/pc.	147	67030020	8,50/pc.	117	67030542	17,06/pc.	110
64030041	2,41/pc.	100	67020044	5,42/pc.	149	67030030	9,80/pc.	105	67030610	9,94/m	73
64030058	1,02/pc.	93	67020045	6,22/m	120	67030043	5,01/pc.	109	67030610	9,94/m	103
64030059	0,26/pc.	71	67020045	6,22/m	147	67030046	2,32/pc.	109	67030611	13,49/m	73
64030059	0,26/pc.	118	67020045	6,22/m	149	67030047	7,48/pc.	101	67030611	13,49/m	104
64030059	0,26/pc.	150	67020046	1,36/pc.	109	67030049	2,64/pc.	108	67030612	19,00/m	73
64030060	1,78/pc.	102	67020048	38,07/pc.	117	67030049	2,64/pc.	129	67030612	19,00/m	104
64030060	1,78/pc.	146	67020051	10,12/pc.	113	67030054	1,38/pc.	132	67031058	1,72/pc.	132
64030061	2,27/pc.	99	67020052	2,06/pc.	113	67030056	1,38/pc.	132	67050520	12,54/pc.	85
64030061	2,27/pc.	146	67020053	4,66/pc.	101	67030058	2,00/pc.	133	67050520	12,54/pc.	110
64030062	0,67/pc.	102	67020054	0,26/pc.	119	67030059	1,14/pc.	119	67050522	20,69/pc.	85
64030072	2,01/pc.	102	67020055	1,03/pc.	132	67030060	3,70/pc.	117	67050522	20,69/pc.	110
64030160	2,18/pc.	147	67020058	1,83/pc.	133	67030061	8,82/pc.	117	67050524	28,48/pc.	85
64060041	8,28/pc.	100	67020059	0,85/pc.	119	67030062	0,24/pc.	119	67050524	28,48/pc.	110
64060058	2,92/pc.	93	67020061	0,21/pc.	88	67030063	0,11/pc.	119	67050610	25,46/m	103
64060059	1,03/pc.	80	67020061	0,21/pc.	119	67030064	33,43/pc.	129	67050611	34,71/m	81
64060059	1,03/pc.	118	67020062	0,17/pc.	119	67030065	0,63/pc.	119	67050611	34,71/m	104
64060060	4,53/pc.	102	67020062	0,17/pc.	147	67030066	0,88/pc.	119	67050612	47,22/m	104
64060061	6,61/pc.	99	67020062	0,17/pc.	149	67030066	0,88/pc.	133	67060010	4,55/pc.	119
64060062	2,37/pc.	102	67020063	0,11/pc.	119	67030068	0,67/pc.	119	67060014	2,56/pc.	88
64080030	5,11/pc.	100	67020077	1,11/pc.	119	67030077	1,68/pc.	119	67060014	2,56/pc.	119
64080035	3,37/pc.	99	67020077	1,11/pc.	133	67030077	1,68/pc.	133	67060043	9,40/pc.	109
64080036	4,80/pc.	100	67020077	1,11/pc.	148	67030077	1,68/pc.	148	67060044	29,37/pc.	88
64080038	4,30/pc.	95	67020079	0,21/pc.	88	67030093	0,50/pc.	71	67060044	29,37/pc.	120
64080040	4,30/pc.	95	67020079	0,21/pc.	119	67030093	0,50/pc.	118	67060045	38,34/m	88
64080041	2,41/pc.	100	67020083	0,08/pc.	88	67030093	0,50/pc.	149	67060045	38,34/m	120
64080046	6,14/pc.	96	67020083	0,08/pc.	119	67030099	0,34/pc.	71	67060046	3,55/pc.	109
64080048	6,14/pc.	96	67020084	0,27/pc.	88	67030099	0,34/pc.	118	67060050	3,81/pc.	109
64080058	1,04/pc.	93	67020084	0,27/pc.	120	67030100	0,47/pc.	71	67060050	3,81/pc.	132
64080060	1,78/pc.	102	67020086	0,36/pc.	88	67030100	0,47/pc.	118	67060053	13,80/pc.	101
64080061	2,27/pc.	99	67020086	0,36/pc.	120	67030101	15,12/pc.	129	67060054	8,35/pc.	132
64080072	2,01/pc.	102	67020092	0,85/pc.	119	67030102	28,63/pc.	129	67060056	8,67/pc.	132
67010016	8,06/pc.	106	67020095	0,18/pc.	88	67030109	0,50/pc.	118	67060058	9,89/pc.	132
67010030	8,91/pc.	105	67020095	0,18/pc.	119	67030109	0,50/pc.	150	67060059	2,40/pc.	119
67010040	4,99/pc.	106	67020098	1,85/pc.	113	67030110	47,80/m	87	67060062	1,12/pc.	88
67010043	4,02/pc.	109	67020100	0,39/pc.	118	67030110	47,80/m	116	67060062	1,12/pc.	119
67010046	1,36/pc.	109	67020110	29,33/m	87	67030111	47,80/m	87	67060063	0,57/pc.	88
67010052	2,06/pc.	113	67020110	29,33/m	116	67030111	47,80/m	116	67060063	0,57/pc.	119
67010053	4,66/pc.	101	67020111	29,33/m	87	67030112	47,80/m	87	67060064	0,83/pc.	88
67010056	1,03/pc.	132	67020111	29,33/m	116	67030112	47,80/m	116	67060064	0,83/pc.	119
67010065	0,51/pc.	119	67020112	29,33/m	87	67030120	9,10/pc.	117	67060065	1,09/pc.	119
67010066	0,68/pc.	119	67020112	29,33/m	116	67030143	5,01/pc.	109	67060066	1,90/pc.	119
67010066	0,68/pc.	133	67020120	5,71/pc.	117	67030158	2,11/pc.	133	67060066	1,90/pc.	133
67010068	0,44/pc.	119	67020140	4,91/pc.	120	67030158	2,11/pc.	148	67060077	3,04/pc.	119
67010093	0,36/pc.	62	67020141	6,03/m	120	67030164	30,87/pc.	129	67060077	3,04/pc.	133
67010093	0,36/pc.	118	67020143	4,02/pc.	109	67030201	2,56/pc.	127	67060099	1,75/pc.	80
67010093	0,36/pc.	149	67020145	7,69/m	120	67030202	5,12/pc.	127	67060100	1,75/pc.	118
67010099	0,27/pc.	62	67020145	7,69/m	147	67030203	14,63/pc.	128	67060141	35,32/m	120
67010099	0,27/pc.	118	67020145	7,69/m	149	67030204	11,20/pc.	128	67060143	9,40/pc.	109

Index

référence	prix en €	page	référence	prix en €	page	référence	prix en €	page	référence	prix en €	page
67060145	48,11/m	88	70020430	85,43/pc.	65	70024430	110,43/pc.	67	70030320	44,24/pc.	75
67060145	48,11/m	120	70020440	119,44/pc.	65	70024440	132,05/pc.	67	70030330	58,42/pc.	75
67060541	41,55/pc.	110	70020450	150,25/pc.	65	70024450	144,05/pc.	67	70030340	111,98/pc.	75
67060542	56,89/pc.	110	70020460	175,24/pc.	65	70024460	187,68/pc.	67	70030350	157,60/pc.	75
67060560	11,45/pc.	110	70021100	14,19/pc.	69	70025110	32,24/pc.	68	70030360	181,30/pc.	75
67060562	19,89/pc.	110	70021200	14,82/pc.	69	70025115	35,99/pc.	68	70030410	68,47/pc.	75
67060564	28,59/pc.	110	70021300	17,88/pc.	69	70025120	41,25/pc.	68	70030420	78,86/pc.	75
67080030	9,80/pc.	105	70021400	17,99/pc.	69	70025130	47,81/pc.	68	70030430	94,81/pc.	75
67080040	7,11/pc.	106	70022110	34,74/pc.	66	70025206	24,33/pc.	68	70030440	171,36/pc.	75
67080043	5,01/pc.	109	70022115	38,81/pc.	66	70025210	24,33/pc.	68	70030450	206,19/pc.	75
67080046	2,32/pc.	109	70022120	44,49/pc.	66	70025215	29,11/pc.	68	70030460	267,17/pc.	75
67080053	7,48/pc.	101	70022130	51,55/pc.	66	70025220	32,03/pc.	68	70031100	20,26/pc.	79
67080143	5,01/pc.	109	70022210	36,19/pc.	66	70025230	48,21/pc.	68	70031200	21,67/pc.	79
67080240	6,31/pc.	107	70022215	40,56/pc.	66	70025240	63,83/pc.	68	70031300	25,68/pc.	79
67080252	2,82/pc.	113	70022220	46,36/pc.	66	70025250	70,29/pc.	68	70031400	26,24/pc.	79
67080340	6,31/pc.	107	70022230	53,55/pc.	66	70025260	92,16/pc.	68	70032110	41,93/pc.	76
67080440	6,31/pc.	107	70022240	99,74/pc.	66	70025320	49,19/pc.	68	70032115	46,80/pc.	76
67160058	12,91/pc.	133	70022250	143,18/pc.	66	70025330	58,12/pc.	68	70032120	54,88/pc.	76
67620058	1,58/pc.	133	70022260	163,63/pc.	66	70025340	69,99/pc.	68	70032130	61,50/pc.	76
67620158	1,64/pc.	133	70022320	52,19/pc.	66	70025350	102,30/pc.	68	70032210	44,69/pc.	76
67630058	1,60/pc.	133	70022330	67,13/pc.	66	70025360	107,12/pc.	68	70032215	48,94/pc.	76
67630158	1,72/pc.	133	70022340	119,35/pc.	66	70025410	40,45/pc.	68	70032220	55,93/pc.	76
67660058	10,11/pc.	133	70022350	139,62/pc.	66	70025420	51,18/pc.	68	70032230	72,17/pc.	76
67660158	10,11/pc.	133	70022360	177,55/pc.	66	70025430	62,74/pc.	68	70032240	123,05/pc.	76
67820058	1,73/pc.	133	70022410	52,42/pc.	66	70025440	45,23/pc.	68	70032250	170,80/pc.	76
67820158	1,73/pc.	133	70022420	73,94/pc.	66	70025450	107,44/pc.	68	70032260	205,36/pc.	76
67830058	1,83/pc.	133	70022430	106,86/pc.	66	70025460	112,44/pc.	68	70032320	63,68/pc.	76
67830158	1,89/pc.	133	70022440	122,55/pc.	66	70026110	32,24/pc.	69	70032330	87,23/pc.	76
67860058	10,44/pc.	133	70022450	139,25/pc.	66	70026115	35,99/pc.	69	70032340	170,92/pc.	76
67860158	10,44/pc.	133	70022460	185,24/pc.	66	70026120	41,25/pc.	69	70032350	214,06/pc.	76
67860158	10,44/pc.	133	70023110	26,05/pc.	67	70026130	47,81/pc.	69	70032360	261,35/pc.	76
68000002	146,00/pc.	105	70023115	29,01/pc.	67	70026206	24,33/pc.	69	70032410	72,39/pc.	76
68000010	2,10/pc.	105	70023120	33,82/pc.	67	70026210	24,33/pc.	69	70032420	97,11/pc.	76
68000020	1,21/pc.	64	70023130	38,55/pc.	67	70026215	29,11/pc.	69	70032430	140,19/pc.	76
68000020	1,21/pc.	73	70023206	21,49/pc.	67	70026220	32,03/pc.	69	70032440	173,94/pc.	76
68000020	1,21/pc.	104	70023210	21,49/pc.	67	70026230	48,21/pc.	69	70032450	227,91/pc.	76
68000032	9,80/pc.	101	70023215	22,45/pc.	67	70026240	63,83/pc.	69	70032460	278,30/pc.	76
68000033	55,45/pc.	101	70023220	24,33/pc.	67	70026250	70,29/pc.	69	70033110	32,24/pc.	76
68000034	6,11/pc.	64	70023230	37,75/pc.	67	70026260	92,16/pc.	69	70033115	35,99/pc.	76
68000034	6,11/pc.	73	70023240	54,33/pc.	67	70026320	43,19/pc.	69	70033120	42,24/pc.	76
68000034	6,11/pc.	101	70023250	62,20/pc.	67	70026330	59,37/pc.	69	70033130	48,94/pc.	76
68000035	12,27/pc.	64	70023260	65,72/pc.	67	70026340	66,62/pc.	69	70033210	34,37/pc.	76
68000035	12,27/pc.	73	70023320	40,94/pc.	67	70026350	79,74/pc.	69	70033215	38,50/pc.	76
68000035	12,27/pc.	101	70023330	47,12/pc.	67	70026360	84,42/pc.	69	70033220	44,00/pc.	76
68000040	1,47/pc.	104	70023340	55,43/pc.	67	70026410	38,44/pc.	69	70033230	50,81/pc.	76
68000049	0,47/pc.	104	70023350	60,18/pc.	67	70026420	46,68/pc.	69	70033240	59,81/pc.	76
68000052	59,04/pc.	104	70023360	61,44/pc.	67	70026430	61,75/pc.	69	70033250	65,37/pc.	76
68000053	101,53/pc.	104	70023410	32,05/pc.	67	70026440	69,25/pc.	69	70033260	71,38/pc.	76
68000058	324,53/pc.	104	70023420	46,88/pc.	67	70026450	82,12/pc.	69	70033320	51,81/pc.	76
68000060	3,08/pc.	110	70023430	50,88/pc.	67	70026460	89,48/pc.	69	70033330	58,42/pc.	76
68000066	342,44/pc.	110	70023440	61,75/pc.	67	70027100	15,20/pc.	66	70033340	62,48/pc.	76
69000400	1,35/pc.	105	70023450	68,32/pc.	67	70027150	17,25/pc.	66	70033350	69,94/pc.	76
70020110	26,24/pc.	65	70023460	71,04/pc.	67	70028110	37,24/pc.	65	70033360	72,86/pc.	76
70020115	29,30/pc.	65	70024110	38,00/pc.	67	70028115	39,26/pc.	65	70033410	41,43/pc.	76
70020120	33,56/pc.	65	70024115	41,00/pc.	67	70028120	45,73/pc.	65	70033420	56,31/pc.	76
70020130	38,94/pc.	65	70024120	47,49/pc.	67	70028130	51,31/pc.	65	70033430	63,00/pc.	76
70020206	25,05/pc.	65	70024130	56,31/pc.	67	70028210	37,81/pc.	65	70033440	69,43/pc.	76
70020210	25,05/pc.	65	70024210	38,99/pc.	67	70028215	40,12/pc.	65	70033450	76,35/pc.	76
70020215	26,88/pc.	65	70024215	39,50/pc.	67	70028220	46,50/pc.	65	70033460	79,07/pc.	76
70020220	28,85/pc.	65	70024220	45,73/pc.	67	70028230	52,43/pc.	65	70034110	46,88/pc.	77
70020230	42,69/pc.	65	70024230	55,80/pc.	67	70030110	30,13/pc.	75	70034115	51,76/pc.	77
70020240	55,16/pc.	65	70024240	63,50/pc.	67	70030115	33,56/pc.	75	70034120	59,92/pc.	77
70020250	63,58/pc.	65	70024250	118,62/pc.	67	70030120	38,55/pc.	75	70034130	69,49/pc.	77
70020260	83,32/pc.	65	70024260	163,48/pc.	67	70030130	51,06/pc.	75	70034210	48,80/pc.	77
70020320	39,43/pc.	65	70024320	53,00/pc.	67	70030210	32,38/pc.	75	70034215	54,06/pc.	77
70020330	50,88/pc.	65	70024330	64,56/pc.	67	70030215	35,11/pc.	75	70034220	62,43/pc.	77
70020340	110,50/pc.	65	70024340	73,63/pc.	67	70030220	40,19/pc.	75	70034230	84,26/pc.	77
70020350	134,17/pc.	65	70024350	133,61/pc.	67	70030230	54,63/pc.	75	70034240	134,38/pc.	77
70020360	138,49/pc.	65	70024360	184,11/pc.	67	70030240	93,63/pc.	75	70034250	193,04/pc.	77
70020410	52,13/pc.	65	70024410	67,78/pc.	67	70030250	143,18/pc.	75	70034260	221,29/pc.	77
70020420	56,31/pc.	65	70024420	80,36/pc.	67	70030260	172,80/pc.	75	70034320	70,36/pc.	77

Index

référence	prix en €	page	référence	prix en €	page	référence	prix en €	page	référence	prix en €	page
70034330	94,00/pc.	77	70039230	56,62/pc.	74	70132220	14,65/pc.	87	71052040	93,58/pc.	81
70034340	142,06/pc.	77	70039240	83,24/pc.	74	70132230	18,99/pc.	87	71052050	119,91/pc.	81
70034350	234,23/pc.	77	70039250	101,99/pc.	74	70132240	23,19/pc.	87	71052060	147,59/pc.	81
70034360	286,33/pc.	77	70039260	122,18/pc.	74	70420911	6,31/pc.	64	73020060	21,88/pc.	66
70034410	91,43/pc.	77	70039320	58,06/pc.	74	70430911	9,57/pc.	73	73020100	21,88/pc.	66
70034420	101,80/pc.	77	70039330	86,93/pc.	74	71000000	7,19/m	64	73020150	25,00/pc.	66
70034430	150,98/pc.	77	70039340	99,43/pc.	74	71000000	7,19/m	73	73020200	28,00/pc.	66
70034440	199,67/pc.	77	70039350	119,98/pc.	74	71020300	8,45/pc.	63	73020300	37,24/pc.	66
70034450	239,43/pc.	77	70039360	140,68/pc.	74	71020400	9,80/pc.	63	73020400	68,68/pc.	66
70034460	292,73/pc.	77	70039410	33,04/pc.	74	71020500	10,99/pc.	63	73020500	86,49/pc.	66
70035110	39,81/pc.	78	70039420	64,12/pc.	74	71020600	13,25/pc.	63	73020600	98,80/pc.	66
70035115	44,43/pc.	78	70039430	90,31/pc.	74	71021005	1,50/pc.	63	73021060	7,27/m	64
70035120	50,93/pc.	78	70039440	105,74/pc.	74	71021006	1,24/pc.	63	73021060	7,27/m	103
70035130	59,05/pc.	78	70039450	123,62/pc.	74	71021010	23,63/pc.	65	73021100	9,39/m	64
70035210	41,88/pc.	78	70039460	145,36/pc.	74	71021015	30,51/pc.	65	73021100	9,39/m	103
70035215	46,94/pc.	78	70050210	50,71/pc.	81	71021020	32,44/pc.	65	73021150	12,17/m	64
70035220	53,61/pc.	78	70050215	57,19/pc.	81	71021030	43,8/pc.	65	73021150	12,17/m	103
70035230	74,05/pc.	78	70050220	88,84/pc.	81	71022010	25,12/pc.	65	73021200	14,82/m	64
70035240	97,32/pc.	78	70050230	116,09/pc.	81	71022015	32,86/pc.	65	73021200	14,82/m	103
70035250	113,74/pc.	78	70050240	163,36/pc.	81	71022020	37,07/pc.	65	73021300	22,59/m	64
70035260	124,05/pc.	78	70050250	237,72/pc.	81	71022030	48,37/pc.	65	73021300	22,59/m	103
70035320	62,06/pc.	78	70050260	240,61/pc.	81	71022040	61,40/pc.	65	73021400	28,94/m	64
70035330	76,62/pc.	78	70051200	21,34/pc.	83	71022050	75,19/pc.	65	73021400	28,94/m	103
70035340	92,06/pc.	78	70052210	62,28/pc.	82	71022060	90,02/pc.	65	73021500	39,21/m	64
70035350	122,61/pc.	78	70052215	68,05/pc.	82	71023020	45,68/pc.	65	73021500	39,21/m	103
70035360	127,68/pc.	78	70052220	87,65/pc.	82	71023030	57,83/pc.	65	73021600	46,01/m	64
70035410	55,58/pc.	78	70052230	116,09/pc.	82	71023040	66,21/pc.	65	73021600	46,01/m	103
70035420	68,17/pc.	78	70052240	235,14/pc.	82	71023050	79,84/pc.	65	73022100	29,01/pc.	66
70035430	80,50/pc.	78	70052250	237,32/pc.	82	71023060	93,58/pc.	65	73022150	32,44/pc.	66
70035440	99,43/pc.	78	70052260	239,13/pc.	82	71024010	24,17/pc.	65	73022200	37,07/pc.	66
70035450	134,87/pc.	78	70053210	45,78/pc.	82	71024020	42,72/pc.	65	73022300	53,18/pc.	66
70035460	140,43/pc.	78	70053215	46,02/pc.	82	71024030	60,05/pc.	65	73022400	78,86/pc.	66
70036110	40,43/pc.	78	70053220	58,68/pc.	82	71024040	70,34/pc.	65	73022500	113,31/pc.	66
70036115	45,20/pc.	78	70053230	59,05/pc.	82	71024050	82,30/pc.	65	73022600	129,41/pc.	66
70036120	51,76/pc.	78	70053240	82,03/pc.	82	71024060	96,73/pc.	65	73023060	22,13/pc.	67
70036130	60,01/pc.	78	70053250	82,11/pc.	82	71030300	11,88/pc.	72	73023100	22,13/pc.	67
70036210	42,13/pc.	78	70053260	82,65/pc.	82	71030400	13,75/pc.	72	73023150	22,45/pc.	67
70036215	47,18/pc.	78	70054210	68,27/pc.	82	71030500	18,75/pc.	72	73023200	23,56/pc.	67
70036220	53,93/pc.	78	70054215	99,45/pc.	82	71030600	22,50/pc.	72	73023300	30,42/pc.	67
70036230	66,26/pc.	78	70054220	90,63/pc.	82	71031005	1,99/pc.	72	73023400	31,74/pc.	67
70036240	86,29/pc.	78	70054230	162,17/pc.	82	71031006	1,76/pc.	72	73023500	38,63/pc.	67
70036250	97,34/pc.	78	70054240	234,84/pc.	82	71031010	25,00/pc.	74	73023600	39,99/pc.	67
70036260	101,11/pc.	78	70054250	237,72/pc.	82	71031015	32,55/pc.	74	73024100	32,81/pc.	68
70036320	56,31/pc.	78	70054260	318,97/pc.	82	71031020	38,00/pc.	74	73024150	35,82/pc.	68
70036330	70,87/pc.	78	70055210	60,30/pc.	83	71031030	50,62/pc.	74	73024200	40,49/pc.	68
70036340	85,68/pc.	78	70055215	71,01/pc.	83	71032010	26,87/pc.	74	73024300	56,50/pc.	68
70036350	98,69/pc.	78	70055220	72,11/pc.	83	71032015	34,37/pc.	74	73024400	87,12/pc.	68
70036360	102,44/pc.	78	70055230	88,27/pc.	83	71032020	41,61/pc.	74	73024500	123,73/pc.	68
70036410	51,73/pc.	78	70055240	112,66/pc.	83	71032030	54,24/pc.	74	73024600	141,44/pc.	68
70036420	61,93/pc.	78	70055250	163,20/pc.	83	71032040	83,24/pc.	74	73025060	26,87/pc.	68
70036430	74,43/pc.	78	70055260	163,20/pc.	83	71032050	101,99/pc.	74	73025100	26,87/pc.	68
70036440	90,81/pc.	78	70056210	44,38/pc.	83	71032060	122,18/pc.	74	73025150	30,06/pc.	68
70036450	103,62/pc.	78	70056215	52,19/pc.	83	71033020	58,06/pc.	74	73025200	34,37/pc.	68
70036460	112,69/pc.	78	70056220	68,99/pc.	83	71033030	86,93/pc.	74	73025300	48,07/pc.	68
70037100	38,43/pc.	75	70056230	84,68/pc.	83	71033040	99,43/pc.	74	73025400	73,94/pc.	68
70037150	43,31/pc.	75	70056240	110,61/pc.	83	71033050	119,98/pc.	74	73025500	106,18/pc.	68
70038110	41,88/pc.	74	70056250	121,71/pc.	83	71033060	140,68/pc.	74	73025600	121,31/pc.	68
70038115	44,80/pc.	74	70056260	132,96/pc.	83	71034010	33,04/pc.	74	73026060	25,99/pc.	69
70038120	53,31/pc.	74	70058210	39,22/pc.	81	71034020	59,92/pc.	74	73026100	25,99/pc.	69
70038130	62,18/pc.	74	70058215	62,18/pc.	81	71034030	84,36/pc.	74	73026150	29,12/pc.	69
70038210	43,11/pc.	74	70058220	68,59/pc.	81	71034040	98,80/pc.	74	73026200	33,24/pc.	69
70038215	46,68/pc.	74	70058230	115,23/pc.	81	71034050	115,56/pc.	74	73026300	46,56/pc.	69
70038220	55,31/pc.	74	70120200	21,99/set	61	71034060	135,88/pc.	74	73026400	71,61/pc.	69
70038230	65,18/pc.	74	70122210	7,34/pc.	87	71050300	17,60/pc.	81	73026500	102,80/pc.	69
70039110	24,56/pc.	74	70122215	8,89/pc.	87	71050400	24,01/pc.	81	73026600	117,49/pc.	69
70039115	32,07/pc.	74	70122220	10,33/pc.	87	71050500	29,68/pc.	81	73030100	26,29/pc.	75
70039120	37,43/pc.	74	70122230	13,35/pc.	87	71050600	34,65/pc.	81	73030150	29,50/pc.	75
70039130	49,87/pc.	74	70122240	16,21/pc.	87	71052010	46,25/pc.	81	73030200	32,93/pc.	75
70039210	26,50/pc.	74	70130200	26,45/set	70	71052015	60,24/pc.	81	73030300	47,06/pc.	75
70039215	33,87/pc.	74	70132210	10,22/pc.	87	71052020	79,82/pc.	81	73030400	79,00/pc.	75
70039220	41,00/pc.	74	70132215	12,38/pc.	87	71052030	102,87/pc.	81	73030500	101,67/pc.	75

Index

référence	prix en €	page	référence	prix en €	page	référence	prix en €	page	référence	prix en €	page
73030600	118,80/pc.	75	73051500	138,82/m	81	75224400	39,18/m	61	75822500	30,68/m	61
73031060	12,19/m	73	73051500	138,82/m	103	75224500	45,11/m	61	75822600	35,93/m	61
73031060	12,19/m	103	73051600	190,38/m	81	75224600	54,00/m	61	75831100	21,82/m	70
73031100	17,01/m	73	73051600	190,38/m	103	75232100	27,26/m	70	75831150	27,18/m	70
73031100	17,01/m	103	73052100	74,13/pc.	82	75232100	27,26/m	149	75831200	33,87/m	70
73031150	23,12/m	73	73052150	92,12/pc.	82	75232150	32,18/m	70	75831300	45,36/m	70
73031150	23,12/m	103	73052200	116,55/pc.	82	75232150	32,18/m	149	75832100	21,20/m	70
73031200	29,25/m	73	73052300	152,27/pc.	82	75232200	38,69/m	70	75832150	28,81/m	70
73031200	29,25/m	103	73052400	294,13/pc.	82	75232200	38,69/m	149	75832200	33,19/m	70
73031300	44,49/m	73	73052500	319,89/pc.	82	75232300	49,25/m	70	75832300	44,38/m	70
73031300	44,49/m	103	73052600	313,64/pc.	82	75232300	49,25/m	149	75832400	56,56/m	70
73031400	57,61/m	73	73053100	49,84/pc.	82	75232400	63,61/m	70	75832500	69,30/m	70
73031400	57,61/m	103	73053150	51,40/pc.	82	75232400	63,61/m	149	75832600	79,69/m	70
73031450	72,07/m	103	73053200	52,27/pc.	82	75232500	84,06/m	70	76011004	14,78/m	45
73031500	70,73/m	73	73053300	68,20/pc.	82	75232600	99,80/m	70	76011006	27,05/m	45
73031500	70,73/m	103	73053400	65,85/pc.	82	75233200	45,25/m	70	76011504	17,54/m	45
73031600	83,86/m	73	73053500	92,19/pc.	82	75233300	62,26/m	70	76012004	20,10/m	45
73031600	83,86/m	103	73053600	95,47/pc.	82	75233400	78,12/m	70	76012006	35,49/m	45
73032100	52,62/pc.	76	73054100	87,11/pc.	83	75233500	91,37/m	70	76012504	24,09/m	45
73032150	57,29/pc.	76	73054150	108,82/pc.	83	75233600	106,05/m	70	76013004	26,35/m	45
73032200	64,49/pc.	76	73054200	106,55/pc.	83	75234100	33,32/m	70	76013006	46,61/m	45
73032300	87,68/pc.	76	73054300	187,65/pc.	83	75234200	48,63/m	70	76014004	34,21/m	45
73032400	137,86/pc.	76	73054400	242,56/pc.	83	75234300	59,87/m	70	76014006	56,57/m	45
73032500	198,23/pc.	76	73054500	303,66/pc.	83	75234400	82,81/m	70	76015004	47,15/m	45
73032600	202,85/pc.	76	73054600	358,80/pc.	83	75234500	95,43/m	70	76015006	68,04/m	45
73033100	25,82/pc.	77	73055100	52,35/pc.	83	75234600	111,18/m	70	76016004	54,30/m	45
73033150	27,31/pc.	77	73055150	59,21/pc.	83	75423200	22,45/m	62	76016006	79,69/m	45
73033200	28,76/pc.	77	73055200	68,99/pc.	83	75423300	29,81/m	62	76120009	7,13/pc.	45
73033300	36,75/pc.	77	73055300	100,23/pc.	83	75423400	42,37/m	62	76452100	64,60/m	80
73033400	38,63/pc.	77	73055400	123,12/pc.	83	75423500	49,36/m	62	76452150	65,29/m	80
73033500	46,75/pc.	77	73055500	148,67/pc.	83	75423600	55,80/m	62	76452200	90,12/m	80
73033600	48,99/pc.	77	73055600	222,41/pc.	83	75424100	20,83/m	62	76452300	113,57/m	80
73034100	39,75/pc.	77	73056100	74,61/pc.	83	75424200	24,18/m	62	76452400	115,89/m	80
73034150	44,49/pc.	77	73056150	78,43/pc.	83	75424300	32,18/m	62	76452500	158,76/m	80
73034200	49,67/pc.	77	73056200	96,86/pc.	83	75424400	44,55/m	62	76452600	201,03/m	80
73034300	81,36/pc.	77	73056300	124,37/pc.	83	75424500	51,36/m	62	76552100	62,79/m	80
73034400	109,37/pc.	77	73056400	190,15/pc.	83	75424600	68,55/m	62	76552150	65,53/m	80
73034500	157,12/pc.	77	73056500	260,62/pc.	83	75433200	45,62/m	71	76552200	90,27/m	80
73034600	179,47/pc.	77	73056600	329,82/pc.	83	75433300	57,19/m	71	76552300	113,81/m	80
73035100	33,13/pc.	78	75121100	8,55/m	62	75433400	97,06/m	71	76552400	116,09/m	80
73035150	37,12/pc.	78	75121150	10,62/m	62	75433500	118,93/m	71	76552500	159,58/m	80
73035200	42,43/pc.	78	75121200	14,06/m	62	75433600	129,36/m	71	76552600	201,78/m	80
73035300	69,56/pc.	78	75121300	18,62/m	62	75434100	42,58/m	71	82002610	30,77/pc.	148
73035400	91,24/pc.	78	75122060	10,44/m	62	75434200	49,57/m	71	82002610	30,77/pc.	151
73035500	131,05/pc.	78	75122100	10,44/m	62	75434300	60,56/m	71	82002611	33,77/pc.	148
73035600	131,05/pc.	78	75122150	13,94/m	62	75434400	100,12/m	71	82002611	33,77/pc.	151
73036100	31,82/pc.	79	75122200	15,11/m	62	75434500	123,12/m	71	82002612	39,94/pc.	148
73036150	35,62/pc.	79	75122300	20,12/m	62	75434600	152,86/m	71	82002612	39,94/pc.	151
73036200	40,69/pc.	79	75122400	29,07/m	62	75522100	10,44/m	61	82002613	45,69/pc.	148
73036300	56,93/pc.	79	75122500	34,12/m	62	75522100	10,44/m	149	82002613	45,69/pc.	151
73036400	87,55/pc.	79	75122600	54,18/m	62	75522150	13,94/m	61	82002622	54,80/pc.	148
73036500	125,81/pc.	79	75131100	24,31/m	71	75522150	13,94/m	149	82002622	54,80/pc.	151
73036600	143,74/pc.	79	75131150	27,88/m	71	75522200	15,11/m	61	82002623	60,87/pc.	148
73050100	54,68/pc.	82	75131200	33,82/m	71	75522200	15,11/m	149	82002623	60,87/pc.	151
73050150	65,09/pc.	82	75131300	44,43/m	71	75522300	20,12/m	61	82002624	72,99/pc.	148
73050200	90,77/pc.	82	75132060	27,37/m	71	75522300	20,12/m	149	82002624	72,99/pc.	151
73050300	98,20/pc.	82	75132100	27,37/m	71	75522400	29,07/m	61	82002625	84,69/pc.	148
73050400	177,72/pc.	82	75132150	35,57/m	71	75522400	29,07/m	149	82002625	84,69/pc.	151
73050500	223,41/pc.	82	75132200	37,76/m	71	75522500	34,12/m	61	91112001	9,00/pc.	261
73050600	229,61/pc.	82	75132300	48,32/m	71	75522600	40,06/m	61	91112002	11,75/pc.	261
73051060	30,63/m	103	75132400	90,74/m	71	75821100	8,55/m	61	91112003	5,17/pc.	262
73051100	43,28/m	81	75132500	102,30/m	71	75821150	10,62/m	61	91112004	5,82/pc.	262
73051100	43,28/m	103	75132600	117,42/m	71	75821200	14,06/m	61	91112006	9,43/pc.	262
73051150	57,74/m	81	75223200	19,74/m	61	75821300	18,62/m	61	92114001	49,08/set	258
73051150	57,74/m	103	75223300	24,94/m	61	75821400	27,92/m	61	92114002	19,43/pc.	258
73051200	70,70/m	81	75223400	36,75/m	61	75822060	sur demande	61	92114003	17,20/set	258
73051200	70,70/m	103	75223500	43,25/m	61	75822100	9,01/m	61	92114004	16,33/set	258
73051300	98,82/m	81	75223600	50,93/m	61	75822150	11,88/m	61	92114007	22,31/set	258
73051300	98,82/m	103	75224100	16,05/m	61	75822200	13,43/m	61	93910002	2,19/pc.	63
73051400	127,57/m	81	75224200	21,25/m	61	75822300	17,49/m	61	93910003	3,95/pc.	63
73051400	127,57/m	103	75224300	26,45/m	61	75822400	21,88/m	61	93910012	2,31/pc.	63

Index

référence	prix en €	page	référence	prix en €	page	référence	prix en €	page	référence	prix en €	page
93910013	3,89/pc.	63	36231202UP9005N	42,57/pc.	51	91110008/6	25,18/pc.	263	ES1026SS	15,04/pc.	130
93930002	3,19/pc.	72	36231202UP9010N	42,57/pc.	51	91110009/2	22,37/pc.	263	ES1036SS	18,74/pc.	131
93930003	5,50/pc.	72	36232002UP9005N	51,02/pc.	51	91110009/6	27,64/pc.	263	ES1047SS	34,85/pc.	131
93930012	2,76/pc.	72	36232002UP9010N	51,02/pc.	51	91110010/2	27,18/pc.	263	ES1067SS	30,99/pc.	130
93930013	5,19/pc.	72	36233302UP9005N	89,58/pc.	51	91110010/6	33,83/pc.	263	ES1186SS	21,29/pc.	131
93950002	7,96/pc.	80	36233302UP9010N	89,58/pc.	51	91110012/2	26,94/pc.	263	ES1325SS	29,67/pc.	131
93950012	8,28/pc.	80	44101004/1	96,75/pc.	249	91110012/6	33,57/pc.	263	ES1358SS	56,06/pc.	131
26103001F1	163,07/pc.	255	44101004/2	96,75/pc.	249	91110014/2	33,50/pc.	263	ES1359SS	56,06/pc.	131
26103001F3	163,07/pc.	255	44101004/4	96,75/pc.	249	91110014/6	35,87/pc.	263	ES1377SS	155,19/pc.	130
26103002F1	163,07/pc.	255	44101006/1	108,73/pc.	249	91110016F2	27,18/pc.	263	ES1546SS	21,87/pc.	131
26103002F3	163,07/pc.	255	44101006/2	108,73/pc.	249	91110016F6	33,28/pc.	263	ES1737SS	62,72/pc.	131
26103003F1	203,73/pc.	255	44101006/4	108,73/pc.	249	91110018F2	32,56/pc.	263	ES2072ASQSS	214,87/pc.	132
26103003F3	203,73/pc.	255	44201004/1	79,93/pc.	247	91110018F6	40,66/pc.	263	ES2073SS	91,49/pc.	132
26103006F1	203,73/pc.	256	44201004/2	79,93/pc.	247	91110020/2	22,90/pc.	263	ES2223SS	39,78/pc.	132
26103006F3	203,73/pc.	256	44201004/4	79,93/pc.	247	91110020/6	28,33/pc.	263	ES2484SS	69,62/pc.	131
26106005F1	216,42/pc.	256	44202004/2	100,00/pc.	247	91111001/2	4,88/pc.	262	ES2785SS	38,39/pc.	132
26106005F3	216,42/pc.	256	44202004/4	100,00/pc.	247	91111002/2	2,66/pc.	262	ES4047SS	28,93/pc.	131
32102001F1	57,24/pc.	248	46100001/1	25,64/pc.	257	91111002/6	2,84/pc.	262	IDT0003	243,62/pc.	244
32102001F3	57,24/pc.	248	46100001/3	25,64/pc.	257	91111003/2	2,66/pc.	262	IDT0004	243,62/pc.	244
32102002F1	61,77/pc.	248	46100002/1	26,46/pc.	257	91111003/6	2,84/pc.	262	IDT0009	474,15/pc.	243
32102002F3	61,77/pc.	248	46100002/3	26,46/pc.	257	91111005/2	4,37/pc.	262	IDT0010	474,15/pc.	243
32112001F1	53,40/pc.	250	46101001F1	51,65/pc.	257	911113003/1	11,75/pc.	260	IDT0011	141,92/pc.	243
32112001F3	53,40/pc.	250	46101001F3	51,65/pc.	257	911113003/3	11,75/pc.	260	IDT0012	141,92/pc.	243
32112002F1	48,55/pc.	250	46102001F1	58,31/pc.	257	911113004/1	35,38/pc.	260	IDT0019	446,25/pc.	241
32112002F3	48,55/pc.	250	46102001F3	58,31/pc.	257	911113004/3	35,38/pc.	260	IDT0020	470,27/pc.	241
32112004F1	59,81/pc.	251	46203002F1	88,31/pc.	257	911113005/1	14,12/pc.	260	IDT0021	505,40/pc.	241
32112004F3	59,81/pc.	251	46203002F3	88,31/pc.	257	911113005/3	14,12/pc.	260	IDT0022	446,25/pc.	241
32112005F1	63,21/pc.	251	46203023F1	113,87/pc.	257	911113006/1	11,55/pc.	260	IDT0023	470,27/pc.	241
32112005F3	63,21/pc.	251	46203023F3	113,87/pc.	257	911113006/3	11,55/pc.	260	IDT0024	505,40/pc.	241
33106003F1	75,24/pc.	248	60102011RSC	316,19/bt.	110	911113007/1	3,62/pc.	260	IDT2917	10,57/pc.	240
33106003F3	75,24/pc.	248	66101001F1	59,66/pc.	252	911113007/3	3,62/pc.	260	IDT2941	141,92/pc.	242
34101003F1	54,57/pc.	250	66101001F3	59,66/pc.	252	911113009/1	17,74/pc.	260	IDT2942	141,92/pc.	242
34101003F3	54,57/pc.	250	66101002F1	70,41/pc.	252	911113009/3	17,74/pc.	260	IDT6298	182,72/pc.	244
34101005F1	69,41/pc.	251	66101002F3	70,41/pc.	252	911113010/1	49,42/pc.	261	IDT6299	182,72/pc.	244
34101005F3	69,41/pc.	251	66101003F1	85,89/pc.	252	911113010/3	49,42/pc.	261	IDT6300	372,56/pc.	242
36061202UP9005N	48,54/pc.	48	66101003F3	85,89/pc.	252	911113011/1	5,76/pc.	261	IDT6301	372,56/pc.	242
36061202UP9010N	48,54/pc.	48	66103001F1	72,36/pc.	254	911113011/3	5,76/pc.	261	IDT6302	318,65/pc.	240
36062002UP9005N	53,85/pc.	48	66103001F3	72,36/pc.	254	911113012/1	4,66/pc.	261	IDT6303	332,66/pc.	240
36062002UP9010N	53,85/pc.	48	66103002F1	89,55/pc.	254	911113012/3	4,66/pc.	261	IDT6304	353,06/pc.	240
36063302UP9005N	86,63/pc.	48	66103002F3	89,55/pc.	254	911113013/1	1,62/pc.	261	IDT6305	318,65/pc.	240
36063302UP9010N	86,63/pc.	48	66103003F1	79,31/pc.	253	911113013/3	1,62/pc.	261	IDT6306	332,66/pc.	240
36071202UP9005N	34,99/pc.	50	66103003F3	79,31/pc.	253	911113014/1	1,32/pc.	261	IDT6307	353,06/pc.	240
36071202UP9010N	34,99/pc.	50	66103004F1	88,14/pc.	253	911113014/3	1,32/pc.	261	IDT6893	14,05/pc.	241
36072002UP9005N	38,74/pc.	50	66103004F3	88,14/pc.	253	911113019/1	5,32/pc.	261	IDT6894	12,87/pc.	240
36072002UP9010N	38,74/pc.	50	66103005F1	95,94/pc.	253	911113019/3	5,32/pc.	261	IDT6894	12,87/pc.	241
36073302UP9005N	75,26/pc.	50	66103005F3	95,94/pc.	253	911113029/1	26,02/pc.	260	IDT6894	12,87/pc.	242
36073302UP9010N	75,26/pc.	50	66108001F1	139,06/pc.	254	911113029/3	26,02/pc.	260	IDT6894	12,87/pc.	243
36151202UP9005N	69,43/pc.	49	66108001F3	139,06/pc.	254	92114001/1	41,16/set	258	IDT6894	12,87/pc.	244
36151202UP9010N	69,43/pc.	49	74109001F3	200,75/pc.	259	92114001/3	41,16/set	258	IDT7218	486,86/pc.	240
36152002UP9005N	79,96/pc.	49	74109002F3	210,77/pc.	259	92114002/1	18,57/pc.	258	IDT7219	769,72/pc.	241
36152002UP9010N	79,96/pc.	49	74109003F3	242,75/pc.	259	92114002/3	18,57/pc.	258	IDT7239	486,86/pc.	240
36153302UP9005N	122,64/pc.	49	74109004F3	252,63/pc.	259	92114005/1	11,19/set	258	IDT7240	769,72/pc.	241
36153302UP9010N	122,64/pc.	49	74109005F3	301,04/pc.	259	92114005/3	11,19/set	258	K5216EZN	194,34/bt.	153
36161202UP9005N	98,03/pc.	49	74109006F3	307,81/pc.	259	92114006/1	11,19/set	258	K5216EZNMS	418,70/bt.	153
36161202UP9010N	98,03/pc.	49	8602204UP9005N	27,14/m	44	92114006/3	11,19/set	258	K5220ZNF	206,53/bt.	153
36162002UP9005N	103,35/pc.	49	8602204UP9010N	27,14/m	44	BODO NA-L	304,50/pc.	194	K5220ZNMS	358,95/bt.	153
36162002UP9010N	103,35/pc.	49	8602404UP9005N	27,14/m	44	BODO NAT-L	386,27/pc.	194	K5225ZNF	220,09/bt.	153
36163302UP9005N	153,07/pc.	49	8602404UP9010N	27,14/m	44	BODO NL	327,29/pc.	173	K5225ZNMS	383,52/bt.	153
36163302UP9010N	153,07/pc.	49	8603204UP9005N	35,20/m	44	BODO NL-CR	599,60/pc.	173	K5232ZNF	128,54/bt.	153
36181204UP9005N	12,05/pc.	53	8603204UP9010N	35,20/m	44	BODO NL-E	1339,99/pc.	173	K5232ZNMS	244,60/bt.	153
36181204UP9010N	12,05/pc.	53	8603404UP9005N	35,20/m	44	BODO NL-MMS	1086,21/pc.	173	K5240ZNF	125,77/bt.	153
36182004UP9005N	13,47/pc.	53	8603404UP9010N	35,20/m	44	BODO NL-SW	441,72/pc.	173	K5250ZNF	149,44/bt.	153
36182004UP9010N	13,47/pc.	53	8605204UP9005N	52,33/m	44	BODO TL-G	56,78/pc.	173	K5250ZNMS	168,48/bt.	153
36183304UP9005N	17,66/pc.	53	8605204UP9010N	52,33/m	44	BODO TL-S	56,78/pc.	173	K5263ZNF	176,81/bt.	153
36183304UP9010N	17,66/pc.	53	8605404UP9005N	62,17/m	44	CEZ070	7,95/pc.	55	K5263ZNMS	192,90/bt.	153
36221202UP9005N	42,57/pc.	52	8605404UP9010N	62,17/m	44	CEZ100	8,53/pc.	55	K6706PO	259,14/bt.	152
36221202UP9010N	42,57/pc.	52	91110006F2	20,32/pc.	263	CEZ120	8,90/pc.	55	K6708PO	292,92/bt.	152
36222002UP9005N	51,02/pc.	52	91110006F6	25,73/pc.	263	CEZ150	12,24/pc.	55	K6708POGMT	406,89/bt.	152
36222002UP9010N	51,02/pc.	52	91110007F2	25,66/pc.	263	CEZ200	13,61/pc.	55	K6710PO	296,91/bt.	152
36223302UP9005N	89,58/pc.	52	91110007F6	32,13/pc.	263	CEZ300	21,01/pc.	55	K6710POGMT	481,69/bt.	152
36223302UP9010N	89,58/pc.	52	91110008/2	19,69/pc.	263	CEZ400	27,48/pc.	55	K6712PO	299,06/bt.	152

Index

référence	prix en €	page	référence	prix en €	page	référence	prix en €	page	référence	prix en €	page
K6712POGMT	555,26/bt.	152	K8501HFHB	12,82/pc.	237	K8625HFHB	5,29/pc.	234	K8821LHB	2,96/pc.	228
K6716EDPO	325,51/bt.	152	K8502HB	4,59/pc.	236	K8626HB	1,74/pc.	233	K8821PHB	2,96/pc.	228
K6716EDPOGMT	355,10/bt.	152	K8502HFHB	12,82/pc.	237	K8626HFHB	5,29/pc.	234	K8822HB	2,96/pc.	228
K6716EPO	222,14/bt.	152	K8503HB	6,52/pc.	236	K8631HB	2,10/pc.	235	K8823/13LHB	4,02/pc.	229
K6716EPOGMT	333,75/bt.	152	K8503HFHB	16,93/pc.	237	K8631HFHB	6,33/pc.	235	K8823/13PHB	4,02/pc.	229
K8401HB	7,77/pc.	213	K8504/EKDHB	5,92/pc.	236	K8632HB	2,10/pc.	235	K8824/12HB	4,02/pc.	229
K8401HFHB	10,87/pc.	213	K8504HB	6,28/pc.	236	K8632HFHB	6,33/pc.	235	K8824/40HB	4,02/pc.	229
K8402HB	7,77/pc.	213	K8504HFHB	16,93/pc.	237	K8633HB	2,84/pc.	235	K8824/41HB	4,02/pc.	229
K8402HFHB	10,87/pc.	213	K8505HB	6,52/pc.	236	K8633HFHB	8,90/pc.	235	K8824/43HB	4,02/pc.	229
K8403HB	15,50/pc.	213	K8505HFHB	16,93/pc.	237	K8634HB	2,84/pc.	235	K8824/44HB	4,02/pc.	229
K8403HFHB	19,12/pc.	213	K8506HB	6,52/pc.	236	K8634HFHB	8,90/pc.	235	K8825HB	4,02/pc.	228
K8404HB	15,50/pc.	213	K8506HFHB	16,93/pc.	237	K8635HB	2,84/pc.	235	K8826HB	4,02/pc.	228
K8404HFHB	19,12/pc.	213	K8511HB	6,05/pc.	237	K8635HFHB	8,90/pc.	235	K8833HB	3,06/pc.	231
K8405HB	15,50/pc.	213	K8512HB	6,05/pc.	237	K8636HB	2,84/pc.	235	K8833KB	3,06/pc.	231
K8405HFHB	19,12/pc.	213	K8513HB	7,98/pc.	237	K8636HFHB	8,90/pc.	235	K8833LB	3,06/pc.	231
K8406HB	15,50/pc.	213	K8514/EKDHB	7,98/pc.	237	K8641HB	2,60/pc.	235	K8834HB	2,79/pc.	231
K8406HFHB	19,12/pc.	213	K8514HB	7,98/pc.	237	K8641HFHB	8,06/pc.	236	K8834KB	2,79/pc.	231
K8407HB	6,11/pc.	213	K8515HB	7,98/pc.	237	K8642HB	2,60/pc.	235	K8834LB	2,79/pc.	231
K8407HFHB	10,87/pc.	213	K8516HB	7,98/pc.	237	K8642HFHB	8,06/pc.	236	K8843HB	3,40/pc.	231
K8440-11HB	3,69/pc.	221	K8541HB	13,32/pc.	222	K8643HB	3,41/pc.	235	K8843KB	3,40/pc.	231
K8440-12HB	4,83/pc.	221	K8542HB	13,32/pc.	222	K8643HFHB	9,05/pc.	236	K8843LB	3,40/pc.	231
K8440-13HB	7,88/pc.	221	K8543HB	20,07/pc.	222	K8644HB	3,41/pc.	235	K8844HB	3,23/pc.	231
K8441HB	16,45/pc.	219	K8544HB	13,32/pc.	222	K8644HFHB	9,05/pc.	236	K8844KB	3,23/pc.	231
K8442HB	16,45/pc.	219	K8545HB	13,32/pc.	222	K8645HB	3,41/pc.	235	K8844LB	3,23/pc.	231
K8443HB	21,57/pc.	219	K8546HB	13,32/pc.	222	K8645HFHB	9,05/pc.	236	K8855/3HB	2,18/pc.	230
K8444HB	21,57/pc.	219	K8550-11HB	3,88/pc.	226	K8646HB	3,41/pc.	235	K8855HB	2,18/pc.	230
K8445HB	21,57/pc.	219	K8550-12HB	4,83/pc.	226	K8646HFHB	9,05/pc.	236	K8856HB	2,18/pc.	230
K8446HB	21,57/pc.	219	K8550-13HB	6,05/pc.	226	K8651HB	3,04/pc.	236	K8861LHB	3,93/pc.	227
K8447HB	9,39/pc.	219	K8551HB	19,11/pc.	223	K8652HB	3,04/pc.	236	K8861LI1	8,47/pc.	227
K8450-11HB	3,89/pc.	221	K8552HB	19,11/pc.	223	K8653HB	4,13/pc.	236	K8861LI2	8,47/pc.	227
K8450-11HFHB	6,62/pc.	221	K8553HB	19,11/pc.	223	K8653RHB	4,13/pc.	236	K8861LSD	8,47/pc.	227
K8450-12HB	4,83/pc.	221	K8554HB	18,14/pc.	223	K8654HB	4,13/pc.	236	K8861PHB	3,93/pc.	227
K8450-12HFHB	8,06/pc.	221	K8555HB	18,14/pc.	223	K8654RHB	4,13/pc.	236	K8861PI1	8,47/pc.	227
K8450-13HB	7,88/pc.	221	K8556HB	18,14/pc.	223	K8655HB	4,13/pc.	236	K8861PI2	8,47/pc.	227
K8450-13HFHB	12,88/pc.	221	K8560-11HB	4,40/pc.	226	K8656HB	4,13/pc.	236	K8861PSD	8,47/pc.	227
K8451HFHB	12,94/pc.	217	K8560-12HB	5,69/pc.	226	K8671HB	1,04/pc.	233	K8865HB	3,93/pc.	227
K8452HFHB	12,34/pc.	217	K8560-13HB	7,51/pc.	226	K8672HB	1,04/pc.	233	K8865I1	8,47/pc.	227
K8453HFHB	18,82/pc.	217	K8561HB	20,37/pc.	224	K8673HB	1,54/pc.	233	K8865I2	8,47/pc.	227
K8454HFHB	18,82/pc.	217	K8562HB	20,37/pc.	224	K8674HB	1,54/pc.	233	K8865SD	4,34/pc.	227
K8455HFHB	19,89/pc.	217	K8563HB	35,87/pc.	224	K8675HB	1,54/pc.	233	K8866HB	3,93/pc.	227
K8456HFHB	18,82/pc.	217	K8564HB	20,37/pc.	224	K8676HB	1,54/pc.	233	K8866I1	8,47/pc.	227
K8457HFHB	7,51/pc.	217	K8565HB	20,37/pc.	224	K8681HB	0,82/pc.	232	K8866I2	8,47/pc.	227
K8461HB	12,33/pc.	218	K8566HB	20,37/pc.	224	K8682HB	0,82/pc.	232	K8866SD	4,34/pc.	227
K8462HB	12,33/pc.	218	K8571HB	23,29/pc.	225	K8683HB	1,22/pc.	232	K8873HB	4,00/pc.	231
K8463HB	19,82/pc.	218	K8572HB	23,29/pc.	225	K8684HB	1,22/pc.	232	K8873KB	4,00/pc.	231
K8464HB	19,82/pc.	218	K8573HB	38,81/pc.	225	K8685HB	1,22/pc.	232	K8873LB	4,00/pc.	231
K8465HB	19,82/pc.	218	K8574HB	23,29/pc.	225	K8686HB	1,22/pc.	232	K8874HB	3,57/pc.	231
K8466HB	19,82/pc.	218	K8575HB	23,29/pc.	225	K8691HB	1,14/pc.	234	K8874KB	3,57/pc.	231
K8467HB	7,02/pc.	218	K8576HB	23,29/pc.	225	K8692HB	1,14/pc.	234	K8874LB	3,57/pc.	231
K8471HB	12,08/pc.	214	K8581HB	6,45/pc.	237	K8693HB	1,76/pc.	234	K8911HB	1,16/pc.	234
K8472HB	12,08/pc.	214	K8582HB	6,45/pc.	237	K8694HB	1,76/pc.	234	K8912HB	1,16/pc.	234
K8473HB	21,27/pc.	214	K8583HB	9,68/pc.	237	K8695HB	1,76/pc.	234	K8913HB	1,66/pc.	234
K8474HB	21,27/pc.	214	K8584/EKDHB	9,68/pc.	237	K8696HB	1,76/pc.	234	K8914HB	1,66/pc.	234
K8475HB	21,27/pc.	214	K8584HB	9,68/pc.	237	K8711HB	1,77/pc.	232	K8915HB	1,66/pc.	234
K8476HB	21,27/pc.	214	K8585HB	9,68/pc.	237	K8712/2HB	2,07/pc.	232	K8916HB	1,66/pc.	234
K8477HB	8,46/pc.	214	K8586HB	9,68/pc.	237	K8713/2HB	2,07/pc.	232	K8921HB	1,04/pc.	233
K8481HB	13,53/pc.	215	K8601HB	1,14/pc.	235	K8714HB	1,77/pc.	232	K8921HFHB	3,34/pc.	233
K8482HB	13,53/pc.	215	K8602HB	1,14/pc.	235	K8715HB	2,07/pc.	232	K8922HB	1,04/pc.	233
K8483HB	21,75/pc.	215	K8603HB	1,74/pc.	235	K8716HB	2,07/pc.	232	K8922HFHB	3,34/pc.	233
K8484HB	21,75/pc.	215	K8604HB	1,74/pc.	235	K8731HB	1,02/pc.	232	K8923HB	1,54/pc.	233
K8485HB	21,75/pc.	215	K8605HB	1,74/pc.	235	K8732HB	1,02/pc.	232	K8923HFHB	4,93/pc.	233
K8486HB	21,75/pc.	215	K8606HB	1,74/pc.	235	K8733HB	1,54/pc.	232	K8924HB	1,54/pc.	233
K8487HB	9,67/pc.	215	K8621HB	1,10/pc.	233	K8734HB	1,54/pc.	232	K8924HFHB	4,93/pc.	233
K8491HB	17,91/pc.	216	K8621HFHB	3,63/pc.	234	K8735HB	1,54/pc.	232	K8925HB	1,54/pc.	233
K8492HB	18,14/pc.	216	K8622HB	1,10/pc.	233	K8736HB	1,54/pc.	232	K8925HFHB	4,93/pc.	233
K8493HB	28,53/pc.	216	K8622HFHB	3,63/pc.	234	K8791HB	1,16/pc.	232	K8926HB	1,54/pc.	233
K8494HB	28,53/pc.	216	K8623HB	1,74/pc.	233	K8792HB	1,16/pc.	232	K8926HFHB	4,93/pc.	233
K8495HB	28,53/pc.	216	K8623HFHB	5,29/pc.	234	K8793HB	1,66/pc.	232	K8931HB	1,70/pc.	234
K8496HB	28,53/pc.	216	K8624HB	1,74/pc.	233	K8794HB	1,66/pc.	232	K8932HB	1,70/pc.	234
K8497HB	12,82/pc.	216	K8624HFHB	5,29/pc.	234	K8795HB	1,66/pc.	232	K8933HB	2,39/pc.	234
K8501HB	4,59/pc.	236	K8625HB	1,74/pc.	233	K8796HB	1,66/pc.	232	K8934HB	2,39/pc.	234

Index

référence	prix en €	page	référence	prix en €	page	référence	prix en €	page	référence	prix en €	page
K8935HB	2,39/pc.	234	KL050KD	7,92/m	231	KRK60X60LD	11,85/m	238	TB80-2	18,89/m	197
K8936HB	2,39/pc.	234	KL050LD	7,92/m	231	KRK60X80LD	13,20/m	238	TB80-2	18,89/m	200
K8991HB	2,18/pc.	236	KL050P2	8,89/m	231	KRK80X60LD	16,56/m	238	TB80-2	18,89/m	203
K8992HB	2,18/pc.	236	KL075HD	10,43/m	231	KSB6.3X35POGMT	68,71/sac	153	TB80-2	18,89/m	204
K8993HB	3,09/pc.	236	KL075KD	10,43/m	231	KSD2S	2,09/pc.	152	TB80-3	17,17/m	197
K8994HB	3,09/pc.	236	KL075LD	10,43/m	231	KSK40X20S	25,79/m	220	TB80-3	17,17/m	200
K8995HB	3,09/pc.	236	KL075P2	12,99/m	231	KSK40X20S	25,79/m	226	TB80-3	17,17/m	203
K8996HB	3,09/pc.	236	KLP35HD	9,49/m	227	KSK40X33S	28,90/m	220	TB80-3	17,17/m	204
KEKD100X40HD	11,72/m	237	KLP35I1	19,32/m	227	KSK40X33S	28,90/m	226	TB80-3	17,17/m	205
KEKD120X40HD	13,86/m	237	KLP35I2	19,32/m	227	KVK20	332,29/pc.	231	TB80-3	17,17/m	206
KEKD80X40HD	9,95/m	236	KLP35SD	13,96/m	227	PDC100-3	4,87/pc.	198	TB80-3	17,17/m	209
KEKD80X40HFHD	30,56/m	237	KLP35TD	13,96/m	227	PDC135-3	5,17/pc.	201	TB80-3	17,17/m	210
KEKE100X60HD	15,64/m	223	KLP80X25HD	11,88/m	228	PK1010-3	26,75/m	198	TB80-3	17,17/m	210
KEKE140X60HD	23,09/m	224	KLPK80X25HD	15,21/m	228	PK1310-3	34,86/m	201	TBA10-1	60,99/m	210
KEKE180X60HD	28,42/m	225	KLR30HB	12,21/m	230	PKE100-3	5,59/pc.	198	TBA10-3	60,99/m	210
KEKE60X60HD	10,67/m	222	KLV11X10HD	1,00/m	232	PKE135-3	5,87/pc.	201	TBA18-1	107,49/m	210
KKPEKEHB	5,48/pc.	226	KLV11X10P2	1,88/m	232	PKJ1	1,94/pc.	198	TBA18-3	107,49/m	210
KKPPKHB	5,46/pc.	221	KLV18X13HD	1,38/m	232	PKJ1	1,94/pc.	201	TBA202-1	17,53/m	209
KKPPKHFB	7,33/pc.	221	KLV18X13P2	2,45/m	232	PROF30-15-1.5-4/GS	5,39/m	126	TBA202-3	17,53/m	209
KKSK100PO	72,76/pc.	154	KLV18X13SD	1,85/m	232	PROF30-15-2.0-2/GS	6,76/m	126	TBA22-1	11,84/m	209
KKSK1252PO6	98,52/pc.	154	KLV18X13TD	1,85/m	232	PROF41-21-2.0-6/HD	14,76/m	126	TBA22-3	11,84/m	209
KKSK125DPO	107,68/pc.	155	KLV24X22HD	2,17/m	232	PROF41-21-2.5-3/HD	18,52/m	126	TBA302-1	33,05/m	209
KKSK125PO10	91,61/pc.	154	KLV24X22P2	3,74/m	232	PROF41-21-2.5-6/HD	18,52/m	126	TBA302-3	33,05/m	209
KKSK125PO6P	106,16/pc.	155	KLV40X15HD	4,28/m	232	PROF41-21-2.5-6/RVS316	101,04/m	130	TBA32-1	12,44/m	209
KKSK1752PO10	126,30/pc.	154	KLV40X15P2	5,45/m	232	PROF41-21-2.5-6/RVS316P	105,60/m	130	TBA32-1	12,44/m	209
KKSK175DPO	141,47/pc.	155	KLZ15X12HD	1,36/m	230	PROF41-41-2.0-6/HD	22,11/m	126	TBA32-3	12,44/m	209
KKSK175PO10P	138,20/pc.	155	KLZK15X12HD	1,36/m	230	PROF41-41-2.5-3/HD	25,13/m	126	TBA32-3	12,44/m	209
KKSK175PO16	126,30/pc.	154	KOKSPLDB	1,94/pc.	127	PROF41-41-2.5-6/HD	25,13/m	126	TBA652-1	43,29/m	209
KL-42W	193,72/pc.	231	KOKSPSDB	3,02/pc.	127	PROF41-41-2.5-6/RVS316	106,37/m	130	TBA652-3	43,29/m	209
KLH15X10HD	1,03/m	232	KPEKD40C	3,02/m	220	PROF41-41-2.5-6/RVS316P	111,16/m	130	TBC100-1	41,99/pc.	197
KLH15X10P2	1,91/m	232	KPEKD40HFC	7,74/m	220	PROFD41-21-2.0-6/HD	33,00/m	127	TBC100-1	41,99/pc.	199
KLH60X40HD	8,17/m	236	KPEKE60C	6,52/m	220	PROFD41-41-2.5-6/HD	56,27/m	127	TBC100-2	46,20/pc.	197
KLHD17X17HD	1,43/m	233	KPEKE60C	6,52/m	226	SNA 6x30/5	173,30/bt.	170	TBC100-3	41,99/pc.	197
KLHD17X17P2	2,17/m	233	KPEPE60/KS	30,21/m	220	TB1010-1	54,61/m	197	TBC100-3	41,99/pc.	198
KLHD20X10HD	1,30/m	233	KPEPE60/KS	30,21/m	226	TB1010-2	60,08/m	197	TBC100-3	41,99/pc.	199
KLHD20X10HFHD	4,61/m	233	KPEPE60HD	12,88/m	220	TB1010-3	54,61/m	197	TBC135-1	41,99/pc.	200
KLHD20X10P2	2,27/m	233	KPEPE60HD	12,88/m	226	TB1032-3	62,29/m	209	TBC135-1	41,99/pc.	202
KLHD20X20HD	1,77/m	233	KPK110X70DHFD	67,01/m	217	TB1040-1	59,04/m	199	TBC135-2	46,20/pc.	200
KLHD20X20HFHD	7,10/m	234	KPK120X55DHD	29,12/m	214	TB1040-3	59,04/m	199	TBC135-3	41,99/pc.	200
KLHD20X20I1	16,44/m	233	KPK140X70DHD	29,94/m	218	TB1310-1	56,39/m	200	TBC135-3	41,99/pc.	201
KLHD20X20I2	16,44/m	233	KPK160X65DHD	39,91/m	215	TB1310-2	62,03/m	200	TBC135-3	41,99/pc.	202
KLHD20X20P2	3,02/m	233	KPK170X70DHD	36,32/m	219	TB1310-3	56,39/m	200	TBC170-1	44,53/pc.	203
KLHD20X20SD	2,20/m	233	KPK210X70DHD	51,94/m	216	TB1340-1	62,54/m	202	TBC170-1	44,53/pc.	204
KLHD20X20TD	2,20/m	233	KPK90X55DHD	16,84/m	213	TB1340-3	62,54/m	202	TBC170-2	48,98/pc.	203
KLHD25X15HD	1,75/m	234	KPK90X55DHFD	45,47/m	213	TB1710-1	71,48/m	203	TBC170-2	48,98/pc.	204
KLHD25X15P2	3,02/m	234	KPKS70/60	10,62/m	220	TB1710-2	78,63/m	203	TBC170-3	44,53/pc.	203
KLHD25X20HD	2,14/m	234	KPKS70/60	10,62/m	226	TB1710-3	71,48/m	203	TBC170-3	44,53/pc.	204
KLHD25X20P2	3,41/m	234	KPLSK	5,14/pc.	220	TB1740-1	72,91/m	204	TBC220-1	47,19/pc.	205
KLHD30X25HD	4,40/m	234	KPN80X252ZHB	7,98/pc.	228	TB1740-2	80,21/m	204	TBC220-1	47,19/pc.	206
KLHD30X25P2	3,57/m	234	KPN80X25HB	7,73/pc.	228	TB1740-3	72,91/m	204	TBC220-3	47,19/pc.	205
KLHD32X15HD	2,03/m	235	KPNEKES	49,80/pc.	226	TB2210-1	96,42/m	205	TBC220-3	47,19/pc.	206
KLHD32X15P2	3,38/m	235	KPNLP352ZHB	6,75/pc.	227	TB2210-3	96,42/m	205	TBD100-1	12,08/pc.	210
KLHD40X20HD	2,77/m	235	KPNLP352ZI1	13,06/pc.	227	TB2240-1	119,98/m	206	TBD100-3	12,08/pc.	210
KLHD40X20HFHD	11,72/m	235	KPNLP352ZI2	13,06/pc.	227	TB2240-3	119,98/m	206	TBD180-1	13,69/pc.	210
KLHD40X20I1	19,11/m	235	KPNLP352ZSD	10,71/pc.	227	TB45-1	12,26/m	199	TBD180-3	13,69/pc.	210
KLHD40X20I2	19,11/m	235	KPNPKS	49,80/pc.	221	TB45-1	12,26/m	202	TBD30-1	10,72/pc.	209
KLHD40X20P2	4,34/m	235	KPSK1HB	3,75/pc.	220	TB45-1	12,26/m	204	TBD30-3	10,72/pc.	209
KLHD40X20SD	4,24/m	235	KQP45X45CBB	13,86/pc.	221	TB45-1	12,26/m	206	TBD65-1	10,84/pc.	209
KLHD40X20TD	4,24/m	235	KQP45X45CHB	12,86/pc.	221	TB45-2	13,48/m	204	TBD65-3	10,84/pc.	209
KLHD40X40HD	4,45/m	235	KRK-OVK20LA	10,96/pc.	238	TB45-3	12,26/m	199	TBE1	10,54/pc.	208
KLHD40X40HFHD	17,42/m	236	KRK-OVK30LB	11,52/pc.	238	TB45-3	12,26/m	202	TBE100	13,19/pc.	208
KLHD40X40SD	8,63/m	235	KRK-OVK40LB	13,33/pc.	238	TB45-3	12,26/m	204	TBE125	16,06/pc.	208
KLHD40X40TD	8,63/m	235	KRK-ST12H20	2,69/m	238	TB45-3	12,26/m	206	TBE20-1	11,56/m	208
KLHD50X20/1HD	3,84/m	236	KRK-ST22H25	7,23/m	238	TB80-1	17,17/m	197	TBE20-3	11,56/m	208
KLHD50X20/2HD	4,13/m	236	KRK-ST6H25	1,66/m	238	TB80-1	17,17/m	200	TBE25	6,93/pc.	208
KLHD50X20HD	3,62/m	236	KRK100X60LD	17,68/m	238	TB80-1	17,17/m	203	TBE3	3,43/pc.	208
KL035HD	5,56/m	231	KRK30X30LD	7,60/m	238	TB80-1	17,17/m	204	TBE50	8,29/pc.	208
KL035KD	7,58/m	231	KRK30X40LD	8,96/m	238	TB80-1	17,17/m	205	TBE75	10,67/pc.	208
KL035LD	7,58/m	231	KRK40X60LD	9,12/m	238	TB80-1	17,17/m	206	TBF1	6,40/pc.	207
KL035P2	5,86/m	231	KRK40X80LD	11,21/m	238	TB80-1	17,17/m	210	TBF11	1,48/pc.	207
KL050HD	7,92/m	231	KRK50X50HFLLD	24,50/m	238	TB80-1	17,17/m	210	TBF2	14,51/pc.	207

Index

référence	prix en €	page	référence	prix en €	page	référence	prix en €	page	référence	prix en €	page
UEK3-R 2	3,77/pc.	182	UGE33-50-S	10,94/set	171	UKE125 25-V E	312,71/pc.	179	UST45FR-CW 2	17,27/pc.	194
UEK3-R 5	3,77/pc.	182	UGE33-80-S	12,90/set	171	UKE125 25-V MS	482,08/pc.	179	UST45FR-CW 3	27,50/pc.	194
UEK3-R 6K	16,79/pc.	182	UGEAR-50S	38,76/set	175	UKE160 15-V E	312,71/pc.	179	UST45FR-R 1	11,11/pc.	194
UEK3-R-G	71,13/pc.	171	UGEAR-80S	40,78/set	175	UKE160 15-VP-WD	429,97/pc.	179	UST45FR-R 2	19,36/pc.	194
UEK3-R-S	71,13/pc.	171	UGEAV-50S	10,94/set	177	UKE160 25-V E	351,80/pc.	179	UST45FR-R 3	30,64/pc.	194
UEK3-V 2	2,34/pc.	182	UGEAV-80S	12,90/set	177	UKE160 25-V MS	527,68/pc.	179	UST45FR-W 1	10,04/pc.	194
UEK3-V 5	2,34/pc.	182	UGEAV1-2 50S	10,94/set	181	UKE185 15-V E	368,70/pc.	180	UST45FR-W 2	17,27/pc.	194
UEK3-V 6K	13,24/pc.	182	UGEAV1-2 80S	13,25/set	181	UKE185 25-V E	397,62/pc.	180	UST45FR-W 3	27,50/pc.	194
UEK3-V-G	58,64/pc.	171	UGEAV2-50S	10,94/set	175	UKE260 15-V E	379,54/pc.	180	UTG	1,55/pc.	185
UEK3-V-S	58,64/pc.	171	UGEAV2-80S	16,57/set	175	UKE260 25-V E	409,66/pc.	180	UTG 75	1,77/pc.	184
UEKD 15-R E	452,12/set	174	UGEE-1-DEP-S	6,28/pc.	193	UKEB 110-40S	14,71/pc.	168	UVB 2-28-190S	57,58/pc.	164
UEKD 15-RP E	625,41/set	174	UGEE-1-UST-S	6,28/pc.	193	UKEB 110-50S	16,42/pc.	168	UVB 2-28-250S	62,36/pc.	164
UEKD 15-V E	251,47/set	176	UGEE-2-UST-S	6,28/pc.	193	UKEB 35-30S	4,63/pc.	168	UVB 2-28-350S	69,97/pc.	164
UEKD 15-VP E	366,12/set	176	UGET-1-5PK 113	19,01/pc.	188	UKEB 35-40S	5,21/pc.	168	UVB 2-38-190S	58,71/pc.	164
UEKD 25-V E	265,80/set	176	UGET-1-RM 113	18,76/pc.	188	UKEB 35-50S	6,90/pc.	168	UVB 2-38-250S	63,01/pc.	164
UEKD 25-V MS	540,95/set	176	UGET-1-UST45 113	21,96/pc.	188	UKEB 60-40S	7,81/pc.	168	UVB 2-38-350S	70,68/pc.	164
UEKD 35-R E	517,27/set	174	UGET-2-3PK 113	19,80/pc.	188	UKEB 60-50S	9,50/pc.	168	UVB 2-48-190S	61,44/pc.	164
UEKD 35-V E	285,35/set	176	UGET-2-AMP 113	18,76/pc.	187	UKEB 85-40S	10,82/pc.	168	UVB 2-48-250S	66,06/pc.	164
UEKD 35-V MS	524,89/set	176	UGET-2-AMPSL 113	18,76/pc.	187	UKEB 85-50S	13,42/pc.	168	UVB 2-48-350S	73,82/pc.	164
UEKD 45-V E	306,20/set	176	UGET-2-BTR 113	18,76/pc.	187	UKEF160 15-V E	284,36/pc.	180	UVB 3-28-190S	69,13/pc.	164
UEKD1-2 15-V E	214,99/pc.	181	UGET-2-COR 113	19,01/pc.	187	UKENP 125S	54,72/pc.	179	UVB 3-28-350S	82,62/pc.	164
UEKD1-2 25-V E	233,23/pc.	181	UGET-2-GG45 113	18,76/pc.	187	UKENP 160S	57,47/pc.	180	UVB 3-38-250S	74,27/pc.	164
UEKD2 15-V E	280,14/pc.	175	UGET-2-KM 113	20,71/pc.	188	UKENP 185S	52,00/pc.	180	UVB 3-38-350S	86,65/pc.	164
UEKD2 25-V E	306,20/pc.	175	UGET-2-KR 113	18,76/pc.	188	UKENP 260S	53,97/pc.	180	UVB 3-48-250S	78,83/pc.	164
UEKD2-R 3	3,39/pc.	182	UGET-2-LCDM 113	18,76/pc.	187	UKL 3-28-250S	50,81/m	164	UVB 3-48-350S	99,36/pc.	164
UEKD2-R-G	54,33/pc.	172	UGET-2-RMSC 113	18,76/pc.	188	UKL 3-28-350S	69,50/m	164	UVS-ST-S1K	4,28/pc.	194
UEKD2-R-S	54,33/pc.	172	UGET-2-XLR 113	18,15/pc.	188	UKL 3-38-250S	56,89/m	164	UVSWI-ST-S1	4,16/pc.	194
UEKD2-V 3	1,94/pc.	182	UGET-3-SCD 113	20,14/pc.	187	UKL 3-38-350S	71,68/m	164	XTB0304	9,72/pc.	208
UEKD2-V-G	47,88/pc.	172	UGET-3-SCS 113	20,14/pc.	187	UKL 3-48-250S	62,54/m	164	XTB0308	16,71/pc.	208
UEKD2-V-S	47,88/pc.	172	UGETD-3 226	26,65/pc.	190	UKL 3-48-350S	73,84/m	164			
UEKDD 15-R E	484,29/pc.	172	UGETD-UZ	12,98/pc.	190	UKR 110-40S	63,84/m	167			
UEKDD 15-V E	368,73/pc.	172	UGKB	31,80/pc.	170	UKR 110-50S	76,88/m	167			
UEKDD 25-V E	390,88/pc.	172	UGR1-4	42,61/set	181	UKR 35-30S	24,44/m	167			
UEKDD1-2 15-V E	191,52/pc.	173	UK 2-28-190S	45,61/m	164	UKR 35-40S	27,86/m	167			
UEKDD1-2 25-V E	207,16/pc.	173	UK 2-28-250S	49,52/m	164	UKR 35-50S	34,22/m	167			
UEKDD2 15-V E	349,20/pc.	173	UK 2-28-350S	69,06/m	164	UKR 60-40S	40,78/m	167			
UEKDD2 25-V E	371,34/pc.	173	UK 2-38-190S	47,77/m	164	UKR 60-50S	46,91/m	167			
UEKDE3-R 6	33,11/pc.	183	UK 2-38-250S	52,11/m	164	UKR 85-40S	59,07/m	167			
UEKDE3-V 6	19,29/pc.	183	UK 2-38-350S	70,81/m	164	UKR 85-50S	65,15/m	167			
UEKDS 25-V6 E	307,50/set	177	UK 2-48-190S	49,07/m	164	UKTR 110S	13,47/m	168			
UEKDS 35-R6 E	646,27/set	175	UK 2-48-250S	53,86/m	164	UKTR 35S	3,79/m	168			
UEKDS 35-V6 E	327,04/set	177	UK 2-48-350S	72,53/m	164	UKTR 60S	11,21/m	168			
UEKDS 45-V6 E	347,88/set	177	UKAZ 110-40S	20,02/pc.	168	UKTR 85S	10,96/m	168			
UEP125-B	2,46/pc.	179	UKAZ 110-50S	20,79/pc.	168	UM 28-190S	12,11/pc.	165			
UEP125-KS 2	4,95/pc.	179	UKAZ 35-30S	sur demande	168	UM 28-250S	12,84/pc.	165			
UEP125-UST 2	6,26/pc.	179	UKAZ 35-40S	12,11/pc.	168	UM 28-350S	14,27/pc.	165			
UEP160-UST 2	6,26/pc.	180	UKAZ 35-50S	12,84/pc.	168	UM 38-190S	12,31/pc.	165			
UEP160-UST 2-TR	9,25/pc.	180	UKAZ 60-40S	12,71/pc.	168	UM 38-250S	13,10/pc.	165			
UET-R-WD	87,29/pc.	178	UKAZ 60-50S	14,16/pc.	168	UM 38-350S	14,60/pc.	165			
UET-R-WD E	235,83/pc.	178	UKAZ 85-40S	19,55/pc.	168	UM 48-190S	12,57/pc.	165			
UET-R-WD-MS	96,95/pc.	178	UKAZ 85-50S	19,55/pc.	168	UM 48-250S	13,21/pc.	165			
UET112-R-WD	97,19/pc.	178	UKBS 28-350S	549,84/pc.	165	UM 48-350S	14,71/pc.	165			
UETD-R-WD	86,33/pc.	178	UKBS 38-350S	573,29/pc.	165	UN 5/38	13,85/bt.	170			
UETD-R-WD E	168,07/pc.	178	UKBS 48-350S	599,36/pc.	165	UNE 260V-100S	90,10/pc.	177			
UETD-R-WD-MMS	169,78/pc.	178	UKBSR 28-350S	22,61/pc.	165	UNE 260V-155S	101,10/pc.	177			
UETD112-R-WD	92,63/pc.	178	UKBSR 38-350S	23,60/pc.	165	UNE 260V-210S	122,28/pc.	177			
UG	5,21/pc.	185	UKBSR 48-350S	24,75/pc.	165	UNE 260V-30S	85,54/pc.	177			
UG-R	8,73/pc.	184	UKD 30S	25,54/m	167	UNE 260V-60S	87,38/pc.	177			
UG3	5,21/pc.	185	UKD 40S	29,32/m	167	UNSKH 260V-100S	91,09/pc.	169			
UG45-4	5,99/pc.	186	UKD 50S	35,38/m	167	UNSKH 308R-100S	117,11/pc.	169			
UG45FRWA-R2	51,10/pc.	189	UKDA-185V 30S	46,21/pc.	167	USH 40	43,20/pc.	178			
UG45FRWA-W2	48,89/pc.	189	UKDA-185V 40S	53,68/pc.	167	USK 120R-150	8,13/pc.	169			
UG45FRWA-W2R2	81,18/pc.	189	UKDA-260R 30S	54,85/pc.	167	USK 120R-82	6,65/pc.	169			
UG45FRWA-W4	71,61/pc.	189	UKDA-260R 40S	60,47/pc.	167	USK 160V-150	11,27/pc.	169			
UG45FRWI-R2	51,10/pc.	189	UKDA-260R 50S	67,88/pc.	167	USK 185V-150	13,42/pc.	169			
UG45FRWI-W2	48,89/pc.	189	UKDA-260V 40S	61,04/pc.	167	USK 259V-150	16,75/pc.	169			
UG45FRWI-W2R2	81,18/pc.	189	UKDA-260V 50S	68,27/pc.	167	USK 259V-225	26,00/pc.	169			
UG45FRWI-W4	71,61/pc.	189	UKDA-308R 40S	61,37/pc.	167	USR 259-150	12,71/pc.	169			
UGE3-RE 4	54,33/pc.	193	UKDA-308R 50S	68,62/pc.	167	USR 308-150	13,81/pc.	169			
UGE3-VE 4	54,33/pc.	193	UKE125 15-V E	286,64/pc.	179	USR 308-225	24,63/pc.	169			
UGE3-VRK 4	54,33/pc.	193	UKE125 15-VP-WD	410,43/pc.	179	UST45FR-CW 1	10,04/pc.	194			

Conditions générales de ventes

Toutes nos ventes sont conclues aux conditions suivantes, auxquelles il ne pourra être dérogé que par conventions expresses et écrites.

1. Nos offres sont faites sans engagement et sauf vente.
2. Tous les marchés sont considérés comme conclus à Deinze.
3. Sauf dispositions contraires expressément acceptées par nous, nos prix s'entendent toujours sans montage, ni pose, ni ajustage.
4. Les clauses figurant dans les correspondances et commandes de l'acheteur et qui dérogent aux présentes conditions ne peuvent être considérées comme acceptées par nous que si nous avons donné expressément notre accord écrit sur le contenu.
5. Les délais de livraison, de fournitures ou d'exécution ne constituent pas un engagement formel de notre part mais ne sont donnés qu'à titre indicatif; un retard de livraison de fournitures ou d'exécution ne peut donner lieu à dommages et intérêts que pour autant que pareille sanction ait été spécialement convenue et que nous l'ayons admise expressément et par écrit.
Même dans cette éventualité, nous serions libérés par tous cas de force majeure, étant entendu que notamment les cas suivants sont conventionnellement à considérer comme tels: grèves, lock-out, panne de courant, d'eau, accident grave aux usines, machines, ateliers et magasins, troubles populaires, émeutes, mobilisations, guerre, gel, inondations, absence sur le marché de matières, etc. Cette énonciation est exemplative et non limitative. Le cas de force majeure ne peut entraîner la résiliation des marchés de la part de l'acheteur, ni le droit de se pourvoir ailleurs pour notre compte, pas plus que l'obligation pour nous de fournir en remplacement des produits d'une autre firme.
6. Les dessins que nous communiquons à nos clients, restent notre propriété et ne peuvent en aucun cas être transmis à des tiers, soit pour leur examen, soit pour leur copie.
Les gravures, photographies et dessins de nos catalogues ne sont donnés qu'à titre indicatif. Les perfectionnements constants que nous apportons à nos fabrications ne nous permettent pas de maintenir l'exécution suivant les cotes mentionnées sur nos plans et dessins. Dès lors les cotes indiquées ne nous engagent pas.
7. Nos marchandises voyagent aux risques et périls exclusifs du destinataire même si nous en assumons le transport. En cas d'avaries ou de manquants, l'acheteur devra adresser une réclamation au transporteur, ou la faire adresser par le destinataire, même si le prix de la marchandise avait été fixé pour livraison franco.
Pour les fournitures «rendues sur chantier» nos camions ne devons pas quitter les chemins carrossables. Les frais résultant d'un stationnement ou déchargement supérieur au délai en usage seront à charge des clients.
8. Les marchandises sont toujours vendues «agrées avant expédition» même lorsque les prix comprennent le transport ou sont fixés à destination ou pose ou placement compris. L'acheteur a toujours le droit de les faire vérifier à ses frais avant l'enlèvement ou l'expédition. Notre acceptation de la commande constitue par elle-même une invitation expresse à venir faire la réception de la marchandise avant départ. L'acheteur est tenu de s'informer lui-même des dates de mise à disposition ou de départ ou d'expédition afin d'exercer en temps utile son droit de contrôle. Faute de l'exercer dans les dites conditions, la marchandise est considérée comme agréée. Par voie de conséquence toute réclamation ultérieure est non recevable.
9. Les réclamations au sujet du contenu ou du libellé des factures doivent se faire dans la semaine de leur réception.
10. Les paiements doivent être effectués à Deinze. Nos conditions s'entendent nettes, paiement vingt pour cent à la commande, le solde à la mise à disposition de la marchandise. Lorsque nos factures ne sont pas réglées à l'échéance prévue, nous nous réservons le droit, sans nouvel avertissement, de faire présenter des effets par nos banquiers, tous frais d'escompte, d'encaissement, etc., à charge de nos clients. Le jour d'enlèvement ou d'expédition de la marchandise sert de base à la fixation des échéances, même en cas de vente franco. Au cas où il aura été convenu que l'acheteur acceptera une ou plusieurs traites, le défaut de retour de celles-ci dans les quatre jours de l'envoi à l'acceptation, rendra leur montant total immédiatement exigible.
Les réclamations ne justifient pas le non-paiement.
L'existence d'une réclamation ou d'une contestation permet uniquement le paiement sous réserve. Le défaut de paiement à l'échéance entraînera de plein droit et sans mise en demeure préalable la majoration du montant de la facture de 15%, sans que cette majoration puisse être inférieure à 25 Euro.
Si des retards surviennent dans le paiement des acomptes prévus, nous nous réservons la faculté d'arrêter les travaux et d'annuler la commande, à notre choix, et sous toutes réserves de droit.
11. Nous nous réservons le droit, même après exécution partielle d'une marché, d'exiger de nos co-contractants une garantie de bonne exécution de leurs propres engagements. Le refus de satisfaire à pareille demande même amiable, nous fonderait à notre choix à surseoir à l'exécution du surplus ou à considérer le marché soit comme résolu, soit comme résilié aux torts et griefs du co-contractant et à tirer de cette résolution toutes conséquences de droit.
12. Nos prix sont établis sur base des conditions économiques, sociales et fiscales en vigueur au moment de notre offre. Toutes modifications à ces conditions, qui surviendraient après la date de notre offre, entraîneraient la révision de nos prix. Toute taxe mise ou venant à être mise sur la vente, la fourniture, la fabrication ou le transport de nos marchandises est toujours à charge de l'acheteur.
13. Sous réserve expresse de nos droits à des dommages et intérêts, il nous est conventionnellement reconnu celui d'annuler les commandes et de considérer le marché comme-résilié même en cours d'exécution et sans sommation préalable - si après la conclusion du marché, l'acheteur néglige d'enlever la marchandise dans les délais fixés, de payer aux dates convenues, d'honorer une traite acceptée, d'exécuter chacune de ses obligations. Toute somme due à terme deviendra dans ce cas immédiatement exigible. Nous nous réservons le droit de résiliation du marché, également en cas de décès, faillite, suspension de paiement, protêt et dissolution de la société ou de la firme acheteuse.
14. Les offres faites ou les engagements pris par les agents et employés de notre firme ne nous lient effectivement qu'après ratification de notre part. Agents et commissionnaires ne sont pas qualifiés pour percevoir le montant des factures et nous ne reconnaissons comme pièce de décharge que celle qui porte notre signature.
15. Les tribunaux de Gand sont seuls compétents en cas de litige, même en cas d'appel en garantie ou de pluralité des défendeurs. La création de promesses ou traites, les acceptations de règlement, envois franco, n'opèrent ni vocation, ni dérogation à cette clause attributive de juridiction.
16. Sans préjudice des dispositions des articles 7 et 8 les marchandises restent la propriété du vendeur jusqu'au paiement intégral du prix.
17. Transport:
 - franc de port à partir de 500 Euro;
 - pour livraison à une autre adresse qu'adresse de livraison habituelle: prix départ usine.



DUCTEL[®]



WIBE



STAGOBEL ELECTRO est l'importateur exclusif de matériel électrique pour l'électro-installateur et l'industrie. Le vaste programme de produits de haute qualité comprend des systèmes de support de câbles économiques pour bâtiments industriels et tertiaires, le matériel de contact CEE, la protection contre la foudre, des composants pour la distribution de courant & les fusibles, des stations de recharge pour e-mobility, des solutions innovatrices pour la gestion des bâtiments et la domotique.

StagobelElectro 
support matters

Zone 1 - De Prijckels | Karrewegstraat 50 | B-9800 Deinze | T 09 381 85 00 | info@stagobel.be | www.stagobel.be



www.facebook.com/StagobelElectro



www.linkedin.com/company/stagobel-electro



www.youtube.com