

Plaque de montage

Référence 18416



- galvanisée
- dimensions: 470 x 295 x 2 mm

Spécifications techniques

Poids	2142 g
Certification de conformité	EAC

Schémas et dimensions

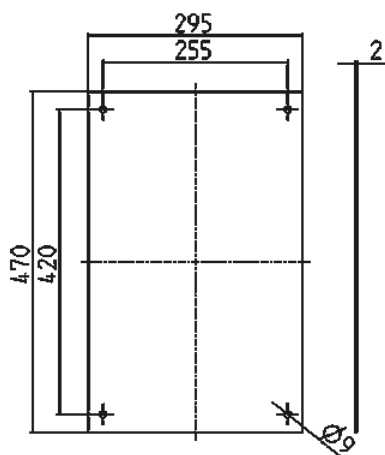

Schéma
5 MB 64

Dim. en mm