

## KFP 20 M10 (754 205)

- Female thread (not cut)



Figure without obligation

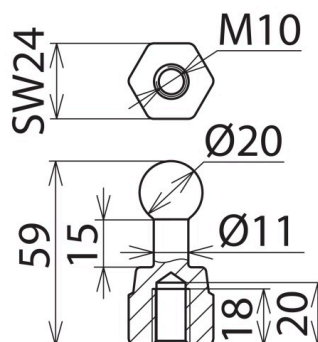

Figure without obligation

Type	KFP 20 M10
Part No.	754 205
Fixed ball point Ø	20 mm
Dimensions	M10
Wrench size	24 mm
Max. cable cross-section Cu	120 mm <sup>2</sup>
Max. short-circuit current I <sub>k</sub> 0.5 s	33.5 kA
Max. short-circuit current I <sub>k</sub> 1 s	23.7 kA
Standard	EN/IEC 61230 (DIN VDE 0683-100) and based on DIN 48088-1
Material (fixed ball point)	E-Cu/gal Sn
Weight	137 g
Customs tariff number (Comb. Nomenclature EU)	85389099
GTIN	4013364097865
PU	1 pc(s)

We reserve the right to introduce changes in performance, configuration and technology, dimensions, weights and materials in the course of technical progress. The figures are shown without obligation.