

## Inbouwcontactdoos

Bestelnr. 1128P



- schroefklemmen
- X-CONTACT®
- rechte uitvoering
- product met lange bussen en pilotcontactbus

## Technische informatie

Ampère	63 A
Polen	5 p
Voltage	400 V
Uurstand	6 h
Hertz	50-60 Hz
Aansluittechniek	schroefklemmen
Contacten	X-CONTACT®
Beschermingsgraad	IP 67
Flens	107x100 mm
Bevestigingsgaten	85x77 mm
Gewicht	775 g
Certificeringen	VDE

## Tekeningen

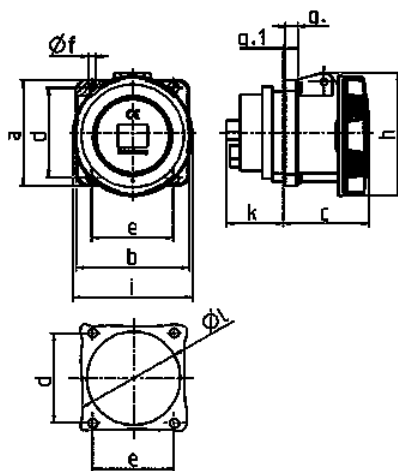

Tekening	Amp. Polen	63			125	
		3	4	5	4	5
<b>1 MB 212/258</b>						
<b>Maten in mm</b>						
a		107	107	107	130	130
b		100	100	100	130	130
c		81	81	81	119	119
d		85	85	85	104	104
e		77	77	77	104	104
f		6	6	6	6,5	6,5
g		12	12	12	18	18
g.1		2	2	2	2	2
h		117	117	117	129	129
i		113	113	113	126	126
k		55	55	55	43	43
l		88	88	88	95	95
<b>Kabelaansluiting</b>						
<b>van/tot mm²</b>		6	6	6	25	25
		-25	-25	-25	-70	-70