

Inbouwcontactdoos

Bestelnr. 1252A

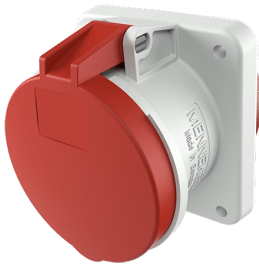

- schroefklemmen
- **X-CONTACT®**
- rechte uitvoering
- producten met lange bussen en pilootcontactbus op aanvraag

Technische informatie

Ampère	63 A
Polen	5 p
Voltage	400 V
Uurstand	6 h
Hertz	50-60 Hz
Aansluittechniek	schroefklemmen
Contacten	X-CONTACT®
Beschermingsgraad	IP 44
Flens	107x100 mm
Bevestigingsgaten	85x77 mm
Gewicht	623 g
Certificeringen	VDE, EAC, CQC

Tekeningen

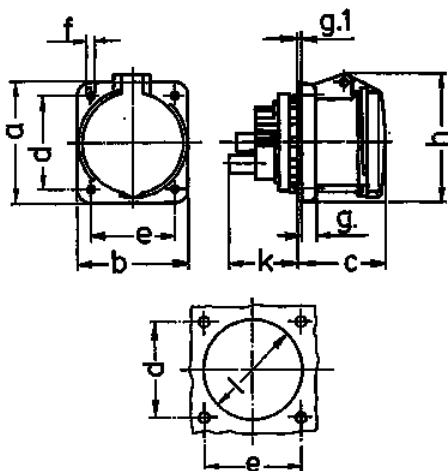

Tekening	Amp. Polen	63		
		3	4	5
1 MB 211				
Maten in mm	a	107	107	107
	b	100	100	100
	c	80	80	80
	d	85	85	85
	e	77	77	77
	f	6	6	6
	g.	12	12	12
	g.1	2	2	2
	h	113	113	113
	k	55	55	55
	l	88	88	88
Kabelaansluiting				
van/tot mm²		6	6	6
		-25	-25	-25