

Inbouwcontactdoos

Bestelnr. 1282



- schroefklemmen
- voor horizontale montage
- 15° hoek

Technische informatie

Ampère	16 A
Polen	4 p
Voltage	400 V
Uurstand	6 h
Hertz	50-60 Hz
Aansluittechniek	schroefklemmen
Contacten	standaard
Beschermingsgraad	IP 44
Flens	85x85 mm
Bevestigingsgaten	70x70 mm
Hoek	15°
Gewicht	155 g
Certificeringen	EAC

Tekeningen

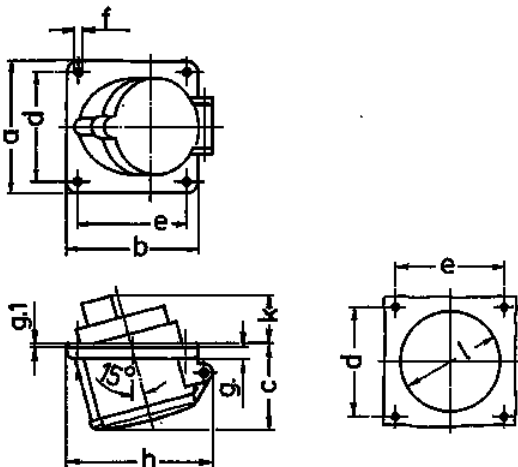

Tekening	Amp.	16			32		
		3	4	5	3	4	5
1 MB 230	Polen						
Maten in mm	a	85	85	85	85	85	85
	b	85	85	85	85	85	85
	c	55	55	56	60	60	60
	d	70	70	70	70	70	70
	e	70	70	70	70	70	70
	f	5,5	5,5	5,5	5,5	5,5	5,5
	g	8	8	8	8	8	8
	g.1	2	2	2	2	2	2
	h	88	93	94	96	96	98
	k	30	30	30	44	44	44
	l	55	60	70	70	70	76
Kabelaansluiting		1,5	1,5	1,5	2,5	2,5	2,5
van/tot mm²		-4	-4	-4	-10	-10	-10