

## Inbouwcontactdoos TwinCONTACT

Bestelnr. 1668



- schroefloos met insteekklemmen
- geschikt voor doorlussen
- rechte uitvoering
- blinddeksel om niet gebruikte opening af te sluiten: bestelnr. 41419

### Technische informatie

Ampère	16 A
Polen	3 p
Voltage	230 V
Uurstand	6 h
Hertz	50-60 Hz
Aansluittechniek	zonder schroeven, TwinCONTACT
Contacten	standaard
Beschermingsgraad	IP 44
Flens	75x75 mm
Bevestigingsgaten	60x60 mm
Gewicht	115 g
Certificeringen	VDE, EAC, CQC

### Tekeningen

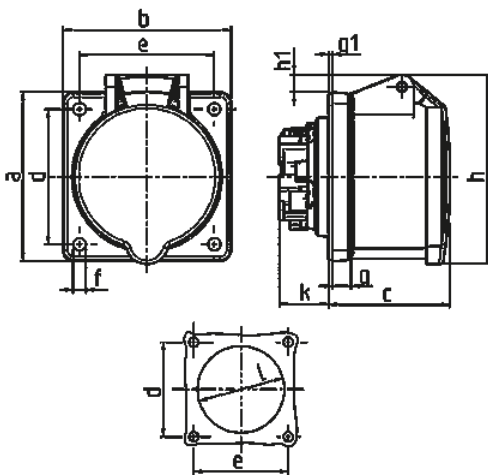

Tekening	Amp.	16			32		
		3	4	5	3	4	5
<b>1 MB 464</b>	<b>Polen</b>						
<b>Maten in mm</b>	<b>a</b>	75	75	75	75	75	75
	<b>b</b>	75	75	75	75	75	75
	<b>c</b>	53	53	54	64	64	64
	<b>d</b>	60	60	60	60	60	60
	<b>e</b>	60	60	60	60	60	60
	<b>f</b>	5,5	5,5	5,5	5,5	5,5	5,5
	<b>g.</b>	8	8	8	8	8	8
	<b>g.1</b>	2	2	2	2	2	2
	<b>h</b>	75	80	85	89	89	95
	<b>h1</b>		5	8	10	10	12
	<b>k</b>	22	22	22	28	28	28
	<b>l</b>	43	52	57	60	60	64
<b>Kabelaansluiting</b>		1,5	1,5	1,5	2,5	2,5	2,5
<b>van/tot mm<sup>2</sup></b>		—4	—4	—4	—6	—6	—6