

Inbouwcontactdoos TwinCONTACT

Bestelnr. 1710



- schroefloos met insteekklemmen
- geschikt voor doorlussen
- rechte uitvoering
- blinddeksel om niet gebruikte opening af te sluiten: bestelnr. 41419

Technische informatie

Ampère	16 A
Polen	4 p
Voltage	110 V
Uurstand	4 h
Hertz	50-60 Hz
Aansluittechniek	zonder schroeven, TwinCONTACT
Contacten	standaard
Beschermingsgraad	IP 67
Flens	75x75 mm
Bevestigingsgaten	60x60 mm
Gewicht	158 g
Certificeringen	EAC, CQC

Tekeningen

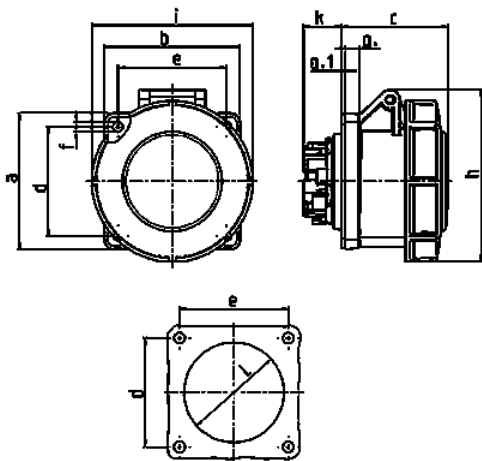

Tekening	Amp.	16			32		
		3	4	5	3	4	5
1 MB 467	Polen						
Maten in mm	a	75	75	75	85	85	85
	b	75	75	75	75	75	75
	c	60	61	61	69	69	72
	d	60	60	60	60	60	60
	e	60	60	60	60	60	60
	f	5,5	5,5	5,5	5,5	5,5	5,5
	g.	8	8	8	8	8	8
	g.1	2	2	2	2	2	2
	h	83	88	95	99	99	105
	i	78	85	96	103	103	110
	k	21	21	21	28	28	38
	l	43	52	54	60	60	65
Kabelaansluiting		1,5	1,5	1,5	2,5	2,5	2,5
van/tot mm²		-4	-4	-4	-6	-6	-6