

Wandcontactdoos

Bestelnr. 1848



- schroefklemmen
- met buitenliggende bevestiging
- kabelinvoer 1 x bov en 1 x blind (breekpoort) aan de achterzijde

Technische informatie

Ampère	32 A
Polen	3 p
Voltage	20-25, 40-50 V
Uurstand	4 h
Hertz	100-200 Hz
Aansluittechniek	schroefklemmen
Contacten	standaard
Beschermingsgraad	IP 44
Gewicht	209 g
Certificeringen	EAC, CQC

Tekeningen

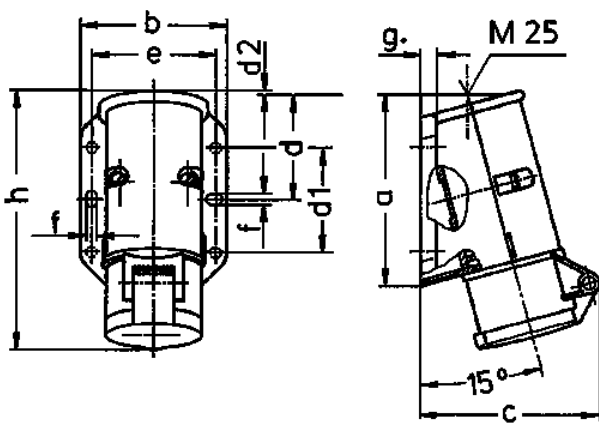

Tekening 1 MB 294	Amp. Polen	16		32	
		2	3	2	3
Maten in mm					
a		96	96	96	96
b		73	73	73	73
c		90	90	90	90
d		53	53	53	53
d1		52	52	52	52
d2		2	2	2	2
e		62	62	62	62
f		5,3	5,3	5,3	5,3
g		8	8	8	8
h		129	129	129	129
Kabelaansluiting van/tot mm ²					
		4	4	4	4
		—10	—10	—10	—10