

Koppelcontactstop ProTOP

Bestelnr. 201



- schroefklemmen
- wartel met afdichting
- trekontlasting met knikbescherming
- behuizing met schroefdraad met vergrendeling

Technische informatie

Ampère	16 A
Polen	3 p
Voltage	50-500 V
Uurstand	10 h
Hertz	100-300 Hz
Aansluittechniek	schroefklemmen
Contacten	standaard
Beschermingsgraad	IP 44
Gewicht	175 g
Certificeringen	EAC

Tekeningen

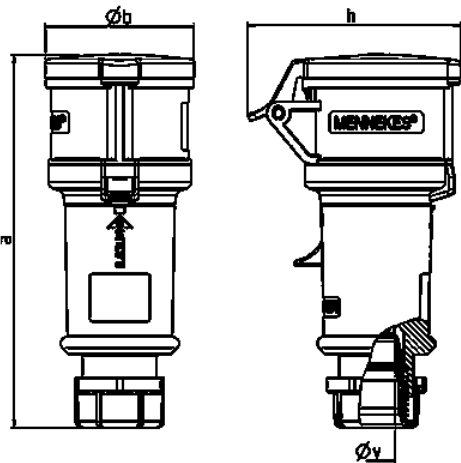

Tekening	Amp. Polen	16			32		
		3	4	5	3	4	5
Maten in mm	a	160	174	172	214	214	210
	b	57	61	69	75	75	80
	h	83	92	98	100	100	108
	y	16	16	16	22	22	22
Kabelaansluiting		1	1	1	2,5	2,5	2,5
van/tot mm²		-2,5	-2,5	-2,5	-6	-6	-6