

Wandcontactdoos

Bestelnr. 20842A



- schroefklemmen
- hittebestendig binnenwerk
- vernikkelde contacten
- binnenliggende bevestiging
- behuizing 180° draaibaar

Technische informatie

Ampère	32 A
Polen	4 p
Voltage	500 V
Uurstand	7 h
Hertz	50-60 Hz
Aansluittechniek	schroefklemmen
Contacten	hittebestendig binnenwerk, vernikkelde contacten
Beschermingsgraad	IP 44
Gewicht	350 g
Certificeringen	EAC

Tekeningen

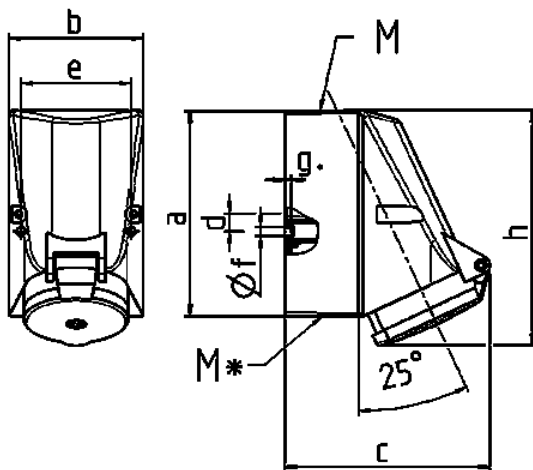

1 MB 209 1 MB 43	Amp. Polen	16			32		
		3	4	5	3	4	5
Maten in mm	a	87	128	128	128	128	128
	b	64	84	84	84	84	84
	c	99	122	124	136	136	138
	d	40	11	11	11	11	11
	e	50	68	68	68	68	68
	f	4,5	5,3	5,3	5,3	5,3	5,3
	g	4	4	4	4	4	4
	h	115	144	145	158	158	160
	M	20	25	25	32	32	32
	M*	20 2x25 (blind) breekpoort			2x25 (blind) breekpoort		
Kabel Ø tot mm		15	18	18	18/25	18/25	18/25
Kabelaansluiting van/tot mm²		1,5	1,5	1,5	2,5	2,5	2,5
		-4	-4	-4	-10	-10	-10