

Inbouwcontactdoos

Bestelnr. 2883



- schroefklemmen
- met hittebestendig binnenwerk
- met vernikkelde contacten
- 20° hoek

Technische informatie

Ampère	16 A
Polen	7 p
Voltage	230 V
Uurstand	9 h
Hertz	50-60 Hz
Aansluittechniek	schroefklemmen
Contacten	hittebestendig binnenwerk, vernikkelde contacten
Beschermingsgraad	IP 67
Flens	100x92 mm
Bevestigingsgaten	85x77 mm
Hoek	20 °
Gewicht	256 g
Certificeringen	EAC, CQC

Tekeningen

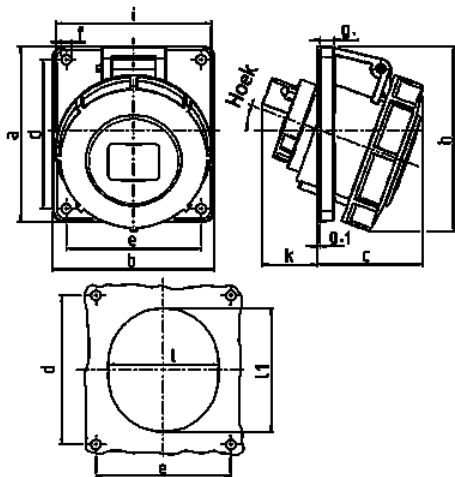

Tekening 1 MB 251	Amp. Polen	16		32	
		7	7	7	7
Maten in mm		a	100	100	100
		b	92	92	92
		c	62	66	66
		d	85	85	85
		e	77	77	77
		f	5,5	5,5	5,5
		g.	8	8	8
		g.1	2	2	2
		h	105	113	113
		i	96	110	110
		k	39	54	54
		l	65	72	72
		n	72	85	85
		o	20°	20°	20°
Kabelansluiting van/tot mm²			1,5	2,5	2,5
			-4	-10	-10