

Inbouwcontactdoos TwinCONTACT

Bestelnr. 3126



- schroefloos met insteekklemmen
- uniforme flensmaat
- 20° hoek
- contactdozen voorbereid op het aansluiten van een hulpcontact

Technische informatie

Ampère	32 A
Polen	3 p
Voltage	230 V
Uurstand	6 h
Hertz	50-60 Hz
Aansluittechniek	zonder schroeven, TwinCONTACT
Contacten	standaard
Beschermingsgraad	IP 44
Flens	85x85 mm
Bevestigingsgaten	70x70 mm
Hoek	20 °
Gewicht	200 g
Certificeringen	VDE, EAC

Tekeningen

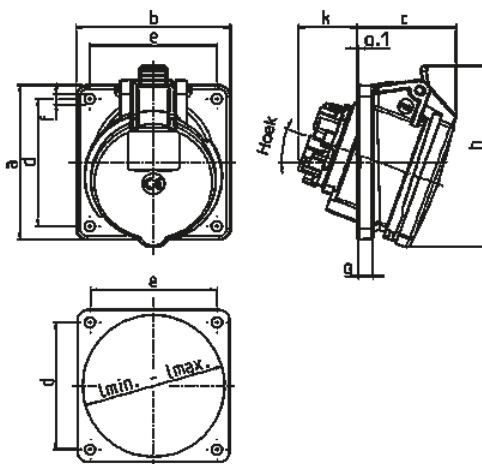

Tekening 1 MB 519	Amp. Polen	16			32		
		3	4	5	3	4	5
Maten in mm							
a		85	85	85	85	85	85
b		85	85	85	85	85	85
c		52	57	55	61	60	66
d		70	70	70	70	70	70
e		70	70	70	70	70	70
f		5,5	5,5	5,5	5,5	5,5	5,5
g		8	8	8	8	8	8
g.1		2	2	2	2	2	2
h		86	96	100	96	104	110
k		31	32	33	43	44	48
l min.		57	64	70	78	78	78
l max.		76	76	76	78	78	78
∅		20	20	20	20	20	20
Kabelaansluiting van/tot mm²							
		1,5	1,5	1,5	2,5	2,5	2,5
		-4	-4	-4	-10	-10	-10