

Toestelcontactstop

Bestelnr. 3531

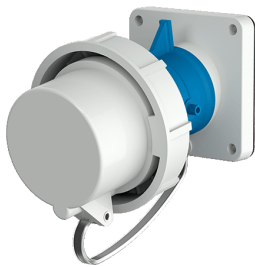

- schroefklemmen
- met afschermkap

Technische informatie

Ampère	16 A
Polen	3 p
Voltage	230 V
Uurstand	6 h
Hertz	50-60 Hz
Aansluittechniek	schroefklemmen
Contacten	standaard
Beschermingsgraad	IP 67
Gewicht	212 g
Certificeringen	VDE, EAC

Tekeningen

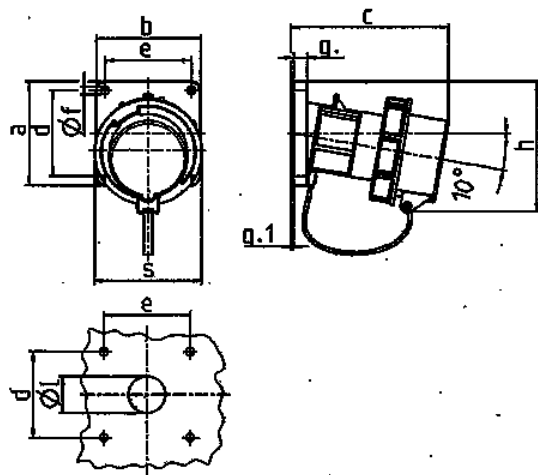

Tekening	Amp.	16		32			63		
		3	5	3	4	5	3	4	5
2 MB 62	Polen								
Maten in mm	a	85	85	85	85	85	108	108	108
	b	85	85	85	85	85	101	101	101
	c	132	132	131	131	137	164	164	164
	d	70	70	70	70	70	85	85	85
	e	70	70	70	70	70	77	77	77
	f	6,3	6,3	6,3	6,3	6,3	6,5	6,5	6,5
	g	11	11	11	11	11	12	12	12
	g.1	2	2	2	2	2	2	2	2
	h	100	107	108	108	111	130	130	130
	s	70	87	94	94	102	114	114	114
	l	30	30	30	30	30	40	40	40
Kabelaansluiting		1	1	2,5	2,5	2,5	6	6	6
van/tot mm²		-2,5	-2,5	-6	-6	-6	-16	-16	-16