

Toestelcontactdoos

Bestelnr. 363



- schroefklemmen

Technische informatie

Ampère	125 A
Polen	4 p
Voltage	230 V
Uurstand	9 h
Hertz	50-60 Hz
Aansluittechniek	schroefklemmen
Contacten	standaard
Beschermingsgraad	IP 67
Gewicht	2061 g
Certificeringen	EAC, CQC

Tekeningen

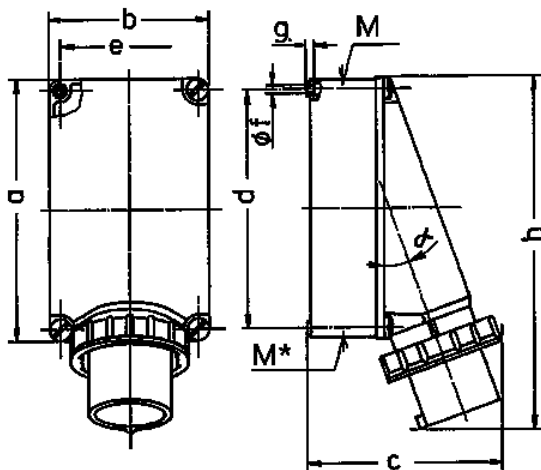

Tekening	Amp.	63			125	
		3	4	5	4	5
2 MB 36	Polen					
Maten in mm	a	170	170	170	264	264
	b	118	118	118	163	163
	c	171	171	171	205	205
	d	134,5	134,5	134,5	240	240
	e	103	103	103	140	140
	f	6,1	6,1	6,1	8,1	8,1
	g	6	6	6	8	8
	h	250	250	250	355	355
	M	40	40	40	50	50
	M*	2x40	2x40	2x40	50	50
	α	25°	25°	25°	20°	20°
Kabel Ø tot mm		27	27	27	38	38
Kabelaansluiting van/tot mm²		6	6	6	16	16
		-16	-16	-16	-35	-35