

## Toestelcontactdoos

Bestelnr. 367



- schroefklemmen

## Technische informatie

Ampère	125 A
Polen	5 p
Voltage	230 V
Uurstand	9 h
Hertz	50-60 Hz
Aansluittechniek	schroefklemmen
Contacten	standaard
Beschermingsgraad	IP 67
Gewicht	2178 g
Certificeringen	EAC, CQC

## Tekeningen

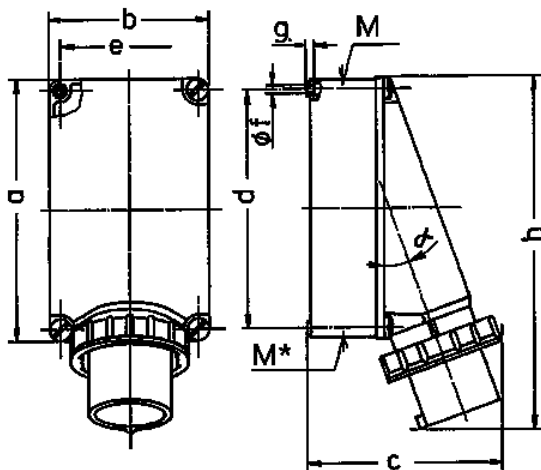

Tekening	Amp.	63			125	
		3	4	5	4	5
<b>2 MB 36</b>	<b>Polen</b>					
<b>Maten in mm</b>	<b>a</b>	170	170	170	264	264
	<b>b</b>	118	118	118	163	163
	<b>c</b>	171	171	171	205	205
	<b>d</b>	134,5	134,5	134,5	240	240
	<b>e</b>	103	103	103	140	140
	<b>f</b>	6,1	6,1	6,1	8,1	8,1
	<b>g</b>	6	6	6	8	8
	<b>h</b>	250	250	250	355	355
	<b>M</b>	40	40	40	50	50
	<b>M*</b>	2x40	2x40	2x40	50	50
	<b>α</b>	25°	25°	25°	20°	20°
	<b>Kabel Ø tot mm</b>	27	27	27	38	38
	<b>Kabelaansluiting van/tot mm<sup>2</sup></b>	6	6	6	16	16
		-16	-16	-16	-35	-35