

Koppelcontactstop PowerTOP®

Bestelnr. 3873



- schroefklemmen
- hittebestendig binnenwerk
- wartel en buitenliggende trekontlasting

Technische informatie

Ampère	16 A
Polen	4 p
Voltage	230 V
Uurstand	9 h
Hertz	50-60 Hz
Aansluittechniek	schroefklemmen
Contacten	hittebestendig binnenwerk
Beschermingsgraad	IP 67
Gewicht	254 g
Certificeringen	EAC

Tekeningen

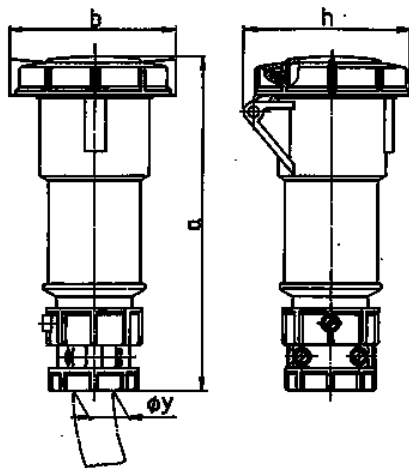

Tekening	Amp. Polen	16			32		
		3	4	5	3	4	5
Maten in mm	a	171	182	194	217	217	229
	b	78	85	96	103	103	110
	h	79	88	95	99	99	105
	y	19	19	22	24,5	24,5	28,5
Kabelaansluiting		1	1	1	2,5	2,5	2,5
van/tot mm²		-2,5	-2,5	-2,5	-6	-6	-6