

Fasenwisselaar AM-TOP®

Bestelnr. 396



- schroefklemmen
- ééndelige behuizing
- wartel met afdichting
- trekontlasting en knikbescherming

Technische informatie

Ampère	32 A
Polen	4 p
Voltage	230 V
Uurstand	9 h
Hertz	50-60 Hz
Aansluittechniek	schroefklemmen
Contacten	standaard
Beschermingsgraad	IP 44
Gewicht	277 g
Certificeringen	EAC, CQC

Tekeningen

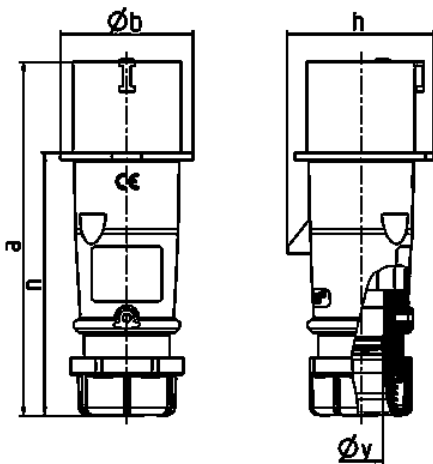

Tekening	Amp. Polen	16			32		
		3	4	5	3	4	5
Maten in mm	a	142	147	147	186	186	180
	b	53	59	67	70	70	77
	h	59	69,4	76	81	81	89,5
	n	105	110	110	141	141	135
	y	14,5	16	16	22	22	22
Kabelaansluiting		1	1	1	2,5	2,5	2,5
van/tot mm²		-2,5	-2,5	-2,5	-6	-6	-6