

Toestelcontactstop

Bestelnr. 480



- schroefklemmen
- met klapdeksel

Technische informatie

Ampère	63 A
Polen	5 p
Voltage	400 V
Uurstand	6 h
Hertz	50-60 Hz
Aansluittechniek	schroefklemmen
Contacten	standaard
Beschermingsgraad	IP 67
Gewicht	200 g
Certificeringen	EAC

Tekeningen

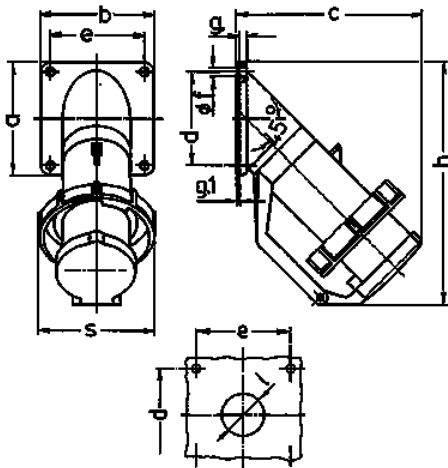

Tekening	Amp. Polen	16		32		63	
		5	3	4	5	4	5
2 MB 40							
Maten in mm	a	85	85	85	85	114	114
	b	85	85	85	85	114	114
	c	141	141	141	144	180	180
	d	70	70	70	70	90	90
	e	70	70	70	70	90	90
	f	6,2	6,2	6,2	6,2	6,2	6,2
	g	6	6	6	6	6	6
	g.1	2	2	2	2	2	2
	h	181	181	181	188	242	242
	s	86	93	93	100	113	113
	l	30	30	30	30	40	40
Kabelaansluiting							
van/tot mm²		1	2,5	2,5	2,5	4	4
		—2,5	—6	—6	—6	—16	—16