

## Koppelcontactstop AM-TOP®

Bestelnr. 544



- schroefklemmen
- ééndelige behuizing
- wartel met afdichting
- trekontlasting en knikbescherming

### Technische informatie

Ampère	16 A
Polen	4 p
Voltage	400 V
Uurstand	6 h
Hertz	50-60 Hz
Aansluittechniek	schroefklemmen
Contacten	standaard
Beschermingsgraad	IP 67
Gewicht	222 g
Certificeringen	VDE, EAC, CQC

### Tekeningen

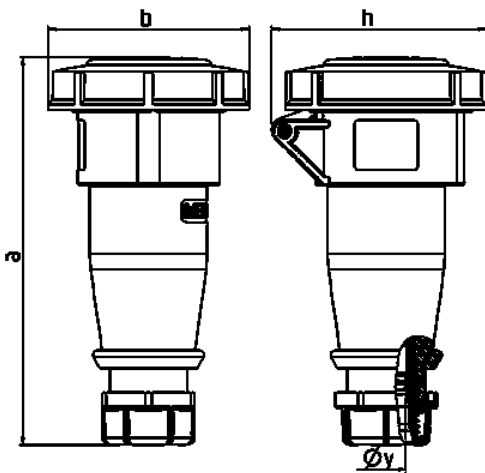

Tekening	Amp. Polen	16			32		
		3	4	5	3	4	5
<b>Maten in mm</b>	<b>a</b>	146	166	172	212	212	213
	<b>b</b>	72	79	89	96	96	102
	<b>h</b>	80	88	95	98	98	105
	<b>y</b>	14,5	16	16	22	22	22
<b>Kabelaansluiting</b>		1	1	1	2,5	2,5	2,5
<b>van/tot mm²</b>		-2,5	-2,5	-2,5	-6	-6	-6