

# DUO

# Wall mounted recept.

Part No.: 5603405G



**MENNEKES**

Elektrotechnik GmbH & Co. KG  
Aloys-Mennekes-Straße 1  
57399 KIRCHHUNDEM GERMANY  
www.MENNEKES.de

# Product Description

- Screw terminals
- Pre-wired for installation
- X-CONTACT®
- Switched
- Mechanical DUO interlock
- 3 pole switch
- Sockets can be padlocked

# Technical Details

DUO - Wall mounted receptacle	5603405G
Product series	DUO
Switch Disconnecter	Yes
Ampere	32 A
Number of Poles	4
Clock position	5 h
Voltage	690 V
Hertz	50-60 Hz
Current Type	AC
Switch type	3P + N + PE
Protection Type	IP44
Mounting method	Wall mounted
Pilot contact	Without pilot contact
Connection	Screw-terminals
Weight (net)	1237 g

Padlocked	Yes
EAN / identification number	4015394298571
Contact carrier	X-CONTACT®
Cable entry	Top & Bottom 2 x M25 top or bottom closed 1 x M25 and 1 x M32 top or bottom closed

**Permissible ambient conditions**

Permanent ambient temperature min. - max.	-25 - +40 °C
---	--------------

**Material properties**

Hinged lid	PC similar RAL 9005 deep black
Upper enclosure part	PC/ASA similar RAL 7035 grey
Enclosure base	PC/ASA similar RAL 9005 deep black
Rotary Switch	PC/ASA similar RAL 7035 grey
Material of exterior screws	PA6 similar RAL 9005 deep black

Regulations and Standards	
REACH (Regulation (EG) No. 1907/2006)	Information according to article 33 REACH: SVHC: Lead (CAS: 7439-92-1)
RoHS 2011/65/EU incl. 2015/863/EU	✓
POP Regulation (EU) 2019/1021	✓
Norm(s)	DIN EN 60309-4
Declaration of conformity	CE, UKCA
Test mark	EAC

# Dimensional drawing

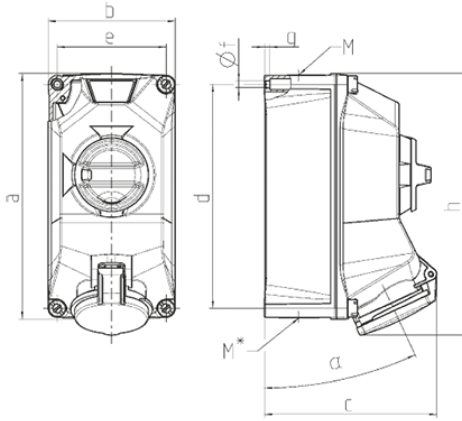

Drawing 1 MB 713	Amp. Poles	16			32		
		3	4	5	3	4	5
Dim. in mm	a	225	225	225	225	225	225
	b	118	118	118	118	118	118
	c	160	160	160	162	162	162
	d	208	208	208	208	208	208
	e	101	101	101	101	101	101
	f	6.4	6.4	6.4	6.4	6.4	6.4
	g	5	5	5	5	5	5
	h	238	244	243	249	249	250
	α		25			25	
	M	1x25 and 1x32			1x25 and 1x32		
	M*	2x25	2x25	2x25	2x25	2x25	2x25
	Max. cable diam. (mm)	25	25	25	25	25	25
	Terminal for cond. cross section (mm <sup>2</sup> ) min.-max.	—10	—10	—10	—10	—10	—10