

**Contactstop**  
Bestelnr. 649A



- schroefklemmen met tule

**Technische informatie**

Ampère	32 A
Polen	3 p
Voltage	20-25 V
Hertz	50-60 Hz
Aansluittechniek	schroefklemmen
Contacten	standaard
Beschermingsgraad	IP 44
Gewicht	155 g
Certificeringen	EAC

**Tekeningen**

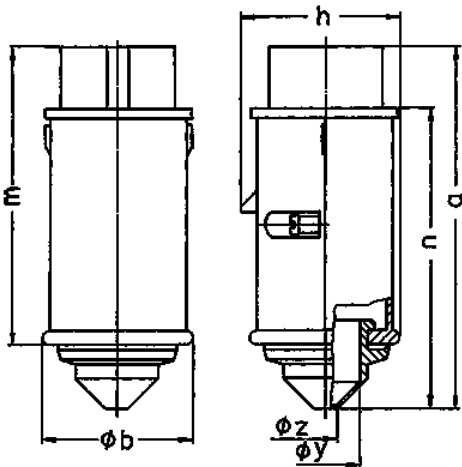

Tekening	Amp. Polen	16		32	
		2	3	2	3
<b>Maten in mm</b>	<b>a</b>	130	130	130	130
	<b>b</b>	55	55	55	55
	<b>h</b>	58	58	58	58
	<b>m</b>	108	108	108	108
	<b>n</b>	107	107	107	107
	<b>y</b>	25	25	25	25
	<b>z</b>	9	9	9	9
<b>Kabelaansluiting</b>		4	4	4	4
<b>van/tot mm²</b>		-10	-10	-10	-10