

Inbouwcontactdoos

Bestelnr. 737



- schroefklemmen
- met hittebestendig binnenwerk
- met vernikkelde contacten
- 20° hoek

Technische informatie

Ampère	16 A
Polen	7 p
Voltage	230 V
Uurstand	9 h
Hertz	50-60 Hz
Aansluittechniek	schroefklemmen
Contacten	hittebestendig binnenwerk, vernikkelde contacten
Beschermingsgraad	IP 44
Flens	100x92 mm
Bevestigingsgaten	85x77 mm
Hoek	20 °
Gewicht	216 g
Certificeringen	EAC, CQC

Tekeningen

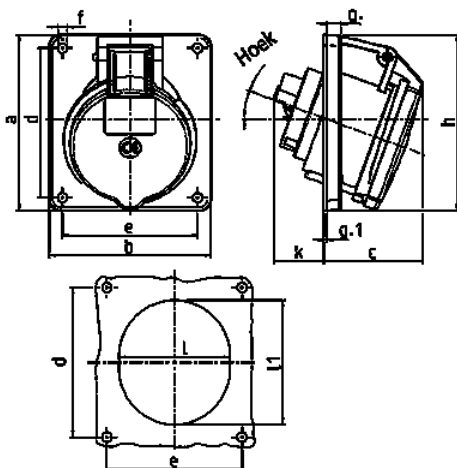

Tekening 1 MB 260	Amp. Polen	16		32	
		7	7	7	7
Maten in mm	a	100		100	
	b	92		92	
	c	58		61	
	d	85		85	
	e	77		77	
	f	5,5		5,5	
	g.	8		8	
	g.1	2		2	
	h	100		106	
	k	40		55	
	l	65		72	
h	72		85		
α	20°		20°		
Kabelaansluiting van/tot mm²		1,5		2,5	
		—4		—10	