

## Toestelcontactstop

Bestelnr. 752



- schroefklemmen
- hittebestendig binnenwerk
- vernikkelde contacten

## Technische informatie

Ampère	32 A
Polen	7 p
Voltage	400 V
Uurstand	6 h
Hertz	50-60 Hz
Aansluittechniek	schroefklemmen
Contacten	vernikkelde contacten, hittebestendig binnenwerk
Beschermingsgraad	IP 44
Gewicht	282 g
Certificeringen	EAC, CQC

## Tekeningen

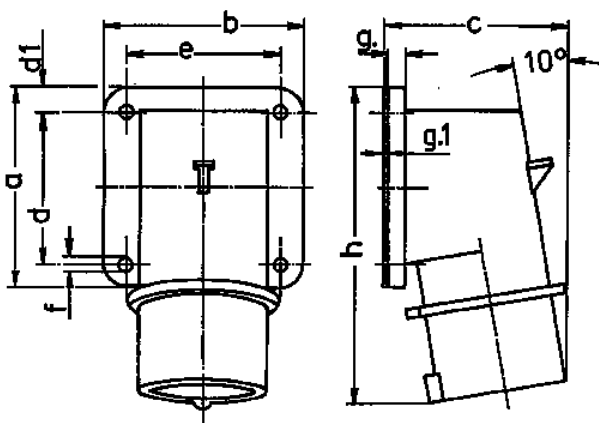

Tekening	Amp.	16	32
<b>2 MB 71</b>	<b>Polen</b>	<b>7</b>	<b>7</b>
<b>Maten in mm</b>	<b>a</b>	85	75
	<b>b</b>	85	90
	<b>c</b>	79	90
	<b>d</b>	64	45
	<b>d1</b>	10	13
	<b>e</b>	64	78
	<b>f</b>	5,5	5,5
	<b>g.</b>	6	6
	<b>g.1</b>	2	2
	<b>h</b>	129	138
<b>Kabelaansluiting</b>			
<b>van/tot mm<sup>2</sup></b>		1	2,5
		-2,5	-6