

Wandcontactdoos

Bestelnr. 7605



- schroefklemmen
- horizontaal
- afschakelbaar
- met mechanische DUO-vergrendeling
- contactdozen zijn met een hangslot afsluitbaar

Technische informatie

| | |
|---------------------|----------------|
| Ampère | 16 A |
| Polen | 4 p |
| Voltage | 400 V |
| Uurstand | 6 h |
| Hertz | 50-60 Hz |
| Aansluittechniek | schroefklemmen |
| Contacten | standaard |
| Beschermingsgraad | IP 44 |
| Behuizing materiaal | Kunststof |
| Gewicht | 1308 g |
| Certificeringen | EAC |

Tekeningen

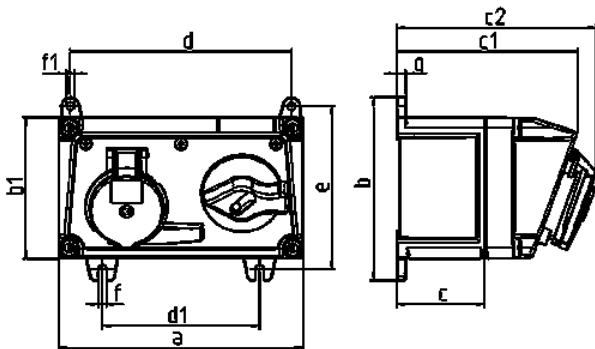

| Tekening 1 MB 550 Maten in mm | Amp. Polen | 16 | | | 32 | | |
|-------------------------------------|---------------|-----|-----|-----|-----|-----|-----|
| | | 3 | 4 | 5 | 3 | 4 | 5 |
| a | | 225 | 225 | 225 | 225 | 225 | 225 |
| b | | 168 | 168 | 168 | 168 | 168 | 168 |
| b1 | | 130 | 130 | 130 | 130 | 130 | 130 |
| c | | 80 | 80 | 80 | 80 | 80 | 80 |
| c1 | | 166 | 166 | 166 | 166 | 166 | 166 |
| c2 | | 182 | 183 | 183 | 193 | 193 | 193 |
| d | | 204 | 204 | 204 | 204 | 204 | 204 |
| d1 | | 145 | 145 | 145 | 145 | 145 | 145 |
| e | | 150 | 150 | 150 | 150 | 150 | 150 |
| f | | 7 | 7 | 7 | 7 | 7 | 7 |
| f1 | | Ø7 | Ø7 | Ø7 | Ø7 | Ø7 | Ø7 |
| g | | 8 | 8 | 8 | 8 | 8 | 8 |