

## Wandcontactdoos

Bestelnr. 7612



- schroefklemmen
- horizontaal
- afschakelbaar
- met mechanische DUO-vergrendeling
- contactdozen zijn met een hangslot afsluitbaar

## Technische informatie

Ampère	32 A
Polen	3 p
Voltage	230 V
Uurstand	6 h
Hertz	50-60 Hz
Aansluittechniek	schroefklemmen
Contacten	standaard
Beschermingsgraad	IP 44
Behuizing materiaal	Kunststof
Gewicht	1482 g
Certificeringen	EAC

## Tekeningen

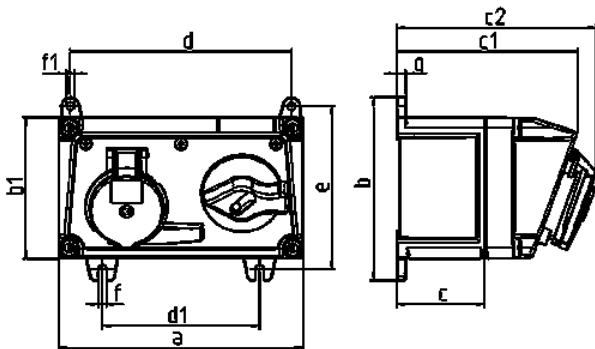

Tekening 1 MB 550 Maten in mm	Amp. Polen	16			32		
		3	4	5	3	4	5
a		225	225	225	225	225	225
b		168	168	168	168	168	168
b1		130	130	130	130	130	130
c		80	80	80	80	80	80
c1		166	166	166	166	166	166
c2		182	183	183	193	193	193
d		204	204	204	204	204	204
d1		145	145	145	145	145	145
e		150	150	150	150	150	150
f		7	7	7	7	7	7
f1		Ø7	Ø7	Ø7	Ø7	Ø7	Ø7
g		8	8	8	8	8	8